



Janet M. Audunson, P.E., Esq.  
Assistant General Counsel

April 3, 2020

**VIA ELECTRONIC DELIVERY**

Honorable Michelle L. Phillips  
Secretary  
New York State Public Service Commission  
Three Empire State Plaza, 19<sup>th</sup> Floor  
Albany, New York 12223-1350

**RE: Case 16-G-0058 – Proceeding on Motion of the Commission as to the Rates, Charges, Rules and Regulations of KeySpan Gas East Corporation d/b/a National Grid for Gas Service**

**KEYSPAN GAS EAST CORPORATION d/b/a NATIONAL GRID:  
GEOTHERMAL GAS REV DEMONSTRATION PROJECT – FINAL  
REPORT**

Dear Secretary Phillips:

KeySpan Gas East Corporation d/b/a National Grid (“National Grid”) concluded the Geothermal Gas REV Demonstration Project in early January 2020 upon all remaining construction activities, including the heat pump installation, at the veterans group home in the Hamlet of Medford, located in the Town of Brookhaven, being completed. As such, National Grid hereby files its final report for the Geothermal Gas REV Demonstration Project which includes a standalone report on Q4 2019 activities in Appendix E. This final report, in combination with the report on Q4 2019 activities incorporated therein, additionally serves to satisfy the Commission’s requirement in the December 16, 2016 *Order Adopting Terms of Joint Proposal and Establishing Gas Rate Plans* in Cases 16-G-0058 and 16-G-0059 that National Grid file annual reports within forty-five (45) days after the end of each rate year providing the status of the implementation of each gas REV demonstration project and findings.

Please direct any questions regarding this filing to:

Rachel McCrea  
Growth Management Lead, NY Energy Solutions  
National Grid  
1125 Broadway  
Albany, New York 12204  
Tel.: 518-433-5030  
Mobile: 518-902-8201  
Email: [Rachel.McCrea@nationalgrid.com](mailto:Rachel.McCrea@nationalgrid.com)

Hon. Michelle L. Phillips, Secretary  
National Grid: Geothermal Gas REV Demonstration Project – Final Report  
April 3, 2020  
Page 2 of 2

Thank you.

Respectfully submitted,

*/s/ Janet M. Audunson*

Janet M. Audunson, P.E., Esq.  
Assistant General Counsel

Enc.

cc: Marco Padula, DPS Staff, w/enclosure (via electronic mail)  
Robert Cully, DPS Staff, w/enclosure (via electronic mail)  
Cynthia McCarran, DPS Staff, w/enclosure (via electronic mail)  
John Sano, DPS Staff, w/enclosure (via electronic mail)  
Davide Maioriello, DPS Staff, w/enclosure (via electronic mail)  
Tara Kapila, w/enclosure (via electronic mail)  
Cathy Hughto-Delzer, w/enclosure (via electronic mail)  
John Rei, w/enclosure (via electronic mail)  
Rachel McCrea, w/enclosure (via electronic mail)  
Owen Brady, w/enclosure (via electronic mail)  
Chong Lin, w/enclosure (via electronic mail)



**Geothermal  
Gas REV Demonstration Project  
Long Island, New York**

**Final Report**

April 3, 2020

## Table of Contents

Acknowledgment .....	ii
Executive Summary .....	1
1.0 Project Background .....	2
2.0 Project Roles and Responsibilities .....	6
3.0 REV Goals Supported .....	8
4.0 Project Key Findings .....	8
5.0 Key Lessons Learned .....	12
6.0 Cumulative Insights from Project.....	22
7.0 Project Hypothesis Tested and Results.....	22
8.0 Project Cost Analysis.....	24
9.0 Key Conclusions.....	27
10.0 Demonstrating Scaled Programs to Accelerate GSHP Adoption.....	27
Appendix A – The Glenwood Village Site Design	
Appendix B – The Glenwood Village Site Inspection Report	
Appendix C – The Medford Site Design	
Appendix D – The Glenwood Village EM&V Report	
Appendix E – Q4 2019 Report	
Appendix F – Installation Photos	



## Acknowledgment

In no particular order, National Grid wants to take the opportunity to acknowledge all demonstration project participants who expressed interest in taking part in the Project including Glenwood Village homeowners, and the Association for Mental Health and Wellness. Second, a tremendous thank you to the property owners/landlords who had the vision to recognize the Geothermal Gas REV Demonstration Project as an opportunity to improve comfort and energy savings for their residents. Third, a thank you to Scott Smith at the New York State Energy Research and Development Authority for his unrelenting support and energy throughout the Project. Fourth, a thank you to the PSEG-LI energy efficiency team for their valued partnership by enabling the delivery of award-winning energy efficiency programs to provide increased comfort and energy savings for all project participants. Fifth, thanks to Miller Environmental Group's ("MEG") Dave Reardon and MEG staff, and PGI Corp., a subcontractor to MEG, for an incident-free and successful installation of a complex geothermal project. Sixth, thanks to Zach Fink of ZBF Geothermal, LLC for his technical guidance and delivery of the geothermal system at the Medford veterans home. Seventh, a thank you to the Frontier Energy, Inc. and Owahgena Consulting, Inc. team for their data collection and evaluation efforts. Eighth, a thank you to John Turley of The GreyEdge Group for inspection services at Glenwood Village. Ninth, National Grid gives a special thanks to Jack DiEnna of GEO-NII for providing industry guidance, field survey support, and technical consultation. Tenth, National Grid wishes to thank NY-GEO board members for sharing technical insights from an industry perspective. Finally, National Grid expresses its appreciation to the New York State Department of Public Service Staff for enabling this valuable opportunity to test and evaluate new energy solutions that unlock value for National Grid's customers and communities.

## Executive Summary

KeySpan Gas East Corporation d/b/a National Grid (“National Grid” or the “Company”) has been maintaining and investing in gas infrastructure projects to provide safe and reliable natural gas service to Long Island customers for decades. Due to the geography of Long Island, a significant amount of new gas mains would be required to serve many new customers outside the reach of the existing gas distribution system. This would result in a substantial cost to current natural gas customers. A ground-source (also known as geothermal, ground-coupled, and geo-exchange) heat pump (“GSHP”) is a renewable heating and cooling technology that may provide a clean and economically viable solution to new customers located outside the Company’s current gas distribution system.

National Grid tested two geothermal well systems to begin the evaluation of their cost effectiveness as a clean heating and cooling system using GSHPs as an alternative technology to natural gas main extensions (the “Project”). The first demonstration site was a shared geothermal well system at a residential community (“Glenwood Village Site”) in the Town of Riverhead. The second demonstration site was a single geothermal well system for a veterans group home in the Hamlet of Medford, Town of Brookhaven (“Medford Site”). Both Project sites are located within the Company’s service territory.

The Project validated several data points of interest, including the financial benefits for customers, the performance of GSHPs, and customer satisfaction. Project participants at the Glenwood Village Site experienced reduced energy costs, with savings ranging from 33% to 67% compared with their previous heating systems. GSHPs at Glenwood Village performed at an average seasonal heating coefficient of performance (“COP”) of 2.83 (283% efficiency). Project participants were also satisfied with the installed GSHPs and noticed additional comfort-related benefits such as improved indoor air quality, reduction of energy bill costs, and removal of safety and health issues of delivered fossil fuels. Due to this valuable learning opportunity, the Company believes GSHPs can serve as an essential long-term solution in the Company’s portfolio strategy to achieve its net-zero by 2050 ambition.

The Project is a test-and-learn demonstration and was designed in accordance with the principals of the New York State Public Service Commission’s (“PSC”) Reforming the Energy Vision (“REV”) Proceeding.<sup>1</sup> This approach aligns with the Company’s effort to test, scale, and deploy clean energy solutions in line with its *Northeast 80x50 Pathway*<sup>2</sup> and net-zero by 2050 ambition, and the State’s clean energy agenda. The Project was approved through the 2016 KEDLI rate proceeding.<sup>3</sup> The purpose of this final report is to provide a summary of the Project, results achieved, lessons learned, and recommendations for a full-scale program.

---

<sup>1</sup> Case 14-M-0101, *Proceeding on Motion of the Commission in Regard to Reforming the Energy Vision* (“REV Proceeding”).

<sup>2</sup> National Grid’s *Northeast 80x50 Pathway* is a blueprint for the region to reduce its greenhouse gas emissions 80% below 1990 levels by 2050 (“80x50”).

<sup>3</sup> See Cases 16-G-0058 *et al.*, *Proceeding on Motion of the Commission as to the Rates, Charges, Rules and Regulations of KeySpan Gas East Corporation d/b/a National Grid for Gas Service et al.*, Order Adopting Terms of Joint Proposal and Establishing Gas Rate Plans (issued December 16, 2016).

## 1.0 Project Background

National Grid is privileged to serve over half a million residential customers on Long Island with clean natural gas. However, approximately 400,000 residential homes on Long Island still rely on traditional fuels such as propane, fuel oil, electric resistance, and kerosene for home heating (see Table 1 below).<sup>4</sup> The Company is committed to supporting communities within National Grid’s service territory to help create a cleaner energy future by testing new products and services while serving its natural gas customers safely and reliably.

Table 1. 2017 American Community Survey 1-Year Estimate House Heating Fuel Data.

House Type	Fuel	United States		New York		Long Island	
		Estimate	Margin of Error	Estimate	Margin of Error	Estimate	Margin of Error
<b>Total:</b>		120,062,818	+/-161,148	7,304,332	+/-18,884	929,077	+/-8,583
<b>Utility gas</b>		57,687,289	+/-100,856	4,339,349	+/-19,510	448,278	+/-10,058
<b>Bottled, tank, or LP gas</b>		5,629,120	+/-44,634	294,973	+/-7,691	17,771	+/-2,587
<b>Electricity</b>		46,773,138	+/-74,559	867,925	+/-13,244	60,708	+/-5,199
<b>Fuel oil, kerosene, etc.</b>		5,649,048	+/-34,800	1,496,843	+/-17,647	390,682	+/-9,225
<b>Coal or coke</b>		114,295	+/-4,650	17,881	+/-1,680	523	+/-432
<b>Wood</b>		2,120,937	+/-21,939	122,088	+/-4,376	4,171	+/-1,226
<b>Solar energy</b>		187,622	+/-6,722	5,988	+/-1,028	1,332	+/-6,97
<b>Other fuel</b>		575,122	+/-10,599	77,386	+/-4,536	3,474	+/-1,180
<b>No fuel used</b>		1,326,247	+/-16,246	81,899	+/-4,724	2,138	+/-1,069

GSHP technology is a renewable heating and cooling technology demonstrated to provide space conditioning and sometimes water heating with efficiencies higher than conventional heating, ventilation, and air conditioning (HVAC) systems. Additionally, as part of the PSC’s New Efficiency: New York Order,<sup>5</sup> New York has set a target for heat pumps in general (GSHPs, air-source heat pumps, and mini-splits) to provide a minimum of 3.566 Tbtu of energy savings by 2025.<sup>6</sup> However, to date, there has been limited widespread market adoption of heat pumps due to high installation cost, long payback periods, and lack of consumer familiarity.<sup>7</sup>

National Grid shares New York’s commitment to mitigating climate change through the reduction of greenhouse gas emissions and is exploring solutions to reduce emissions from our customer’s

<sup>4</sup> U.S. Census Bureau, American FactFinder, New York, Table B25040, House Heating Fuel, 2017 American Community Survey 1-Year Estimates.

<sup>5</sup> Case 18-M-0084, *In the Matter of a Comprehensive Energy Efficiency Initiative*, Order Adopting Accelerated Energy Efficiency Targets (issued December 13, 2018) (“New Efficiency: New York Order”).

<sup>6</sup> Case 18-M-0084, *In the Matter of a Comprehensive Energy Efficiency Initiative*, Order Authorizing Utility Energy Efficiency and Building Electrification Portfolios through 2025 (issued January 16, 2019), Appendix C.

<sup>7</sup> Liu, X., Polsky, Y., Qian, D., & McDonald, J. (2019). An Analysis on Cost Reduction Potential of Vertical Bore Ground Heat Exchangers Used for Ground Source Heat Pump Systems. Oak Ridge National Lab.(ORNL), Oak Ridge, TN (United States).

energy use. As a full-season heating solution that is reliable, renewable, and highly efficient, the Company believes that GSHPs may be well suited as an alternative solution for customers seeking gas service. Based on the positive results of this Project, National Grid is exploring ways to make GSHPs more affordable and accessible so that it can help customers meet their energy needs while achieving the State’s clean energy ambitions.

For a traditional gas company to gain first-hand knowledge and experience with the technology, the Company tested and collected performance data of GSHPs on Long Island to validate real-world technical feasibility and technology performance.

Both the Glenwood Village Site and the Medford Site are in Suffolk County on Long Island. The criteria for Project eligibility were homes that are located more than 1,000 feet from an existing gas main using fuel oil or kerosene as the primary heating fuel. A map of the two GSHP sites is represented in Figure 1 below.



Figure 1. Google Map of Project sites. The Glenwood Village Site is in the Town of Riverhead, Long Island. The Medford Site is in the Hamlet of Medford, Town of Brookhaven, Long Island.

The Glenwood Village Site consists of a community loop GSHP in a residential housing development. All ten homes at Glenwood Village participating in the Project were pre-fabricated manufactured houses, ranging from 900 to 1,600 square feet of occupied space, built between 1975 and 2017. Each of the ten homes surrounds a community recreational area, which allowed for a unique opportunity to test a shared, thirty-ton central ground-loop heat exchanger. Each of the ten homeowners allowed the Company, through its contractors, to replace their fuel-fired furnaces (either kerosene or propane) with a GSHP with a capacity of 3 tons of cooling. The GSHPs were sized to the current edition “Manual J” heating and cooling load standard analysis performed for each home and operate with minimum to no reliance on electric resistance heating.<sup>8</sup> Due to site restrictions, a central pump house was not installed. Therefore, each GSHP at Glenwood Village

<sup>8</sup> ANSI/ACCA 2 Manual J Residential Load Calculations Standard. Manual J calculates the amount of heating and cooling load required to maintain a comfortable temperature by taking to account several building characteristics such as square footage, building material, and building orientation.

is equipped with an individual water pump station to circulate water between the GSHP unit and the heat exchanger. The GSHP systems at the Glenwood Village Site were installed by Miller Environmental Group, Inc. The complete technical system design for Glenwood Village is provided in Appendix A to this final report. A certified geothermal inspector was hired to provide a third-party review of the installation process at the Glenwood Village Site and the inspection report is provided in Appendix B to this final report.

The Project received immense support, both financially and technically, from the local electric company, PSEG-Long Island (“PSEG-LI”), and the New York State Energy Research and Development Authority (“NYSERDA”). The financial support reduced the Project cost, which allowed the Company to offer a 3-ton GSHP installation to a new construction, single-family home in the Hamlet of Medford, Town of Brookhaven, constructed by the United Way of Long Island for the Association for Mental Health and Wellness to house four veterans. The single loop construction configuration is more prominent in current installations across New York State and provided the Company with a comparison between two types of GSHP loop designs. However, due to building construction delays, the underground heat exchanger was not installed until July 2019. Final plumbing, electrical, and ductwork were completed in January 2020, at which time the heat pump was installed and commissioned. As a result, limited performance data exists as of the writing of this final report. The GSHP system at the Medford Site was installed by ZBF Geothermal, LLC. Complete technical system design for the Medford Site is provided in Appendix C to this final report.

Since data collection for all eleven homes (including the ten at Glenwood Village) will be integrated with that of other projects participating in NYSEDA’s Program Opportunity Notice (“PON”) 3127,<sup>9</sup> performance data will continue to be analyzed in conjunction with an additional thirty-six GSHPs being installed on Long Island. One of the five demonstration projects under PON 3127 is to validate GSHP performance on Long Island to address barriers to widespread adoption of emerging technologies.

Evaluation, measurement, and verification (“EM&V”) was performed in partnership with NYSEDA by independent firms, Frontier Energy, Inc. and Owahgena Consulting, Inc. The EM&V report is provided in Appendix D to this report. Lastly, weatherization improvements at the Glenwood Village Site were performed by American AWS Corp.

## 1.1 Project Goals and Aims

The Project aimed to determine if GSHP technology is a technically and economically viable option for a gas utility to provide low-cost heating where gas service is not available due to excessive distance to a gas main or gas system constraints. To achieve this, the Project focused mainly on data collection. The Project also evaluated GSHPs as a potential option to mitigate growing peak demand and constrained areas for natural gas.

---

<sup>9</sup> See NYSEDA PON 3127 Emerging Technology Demonstration Projects – Residential HVAC where five demonstration projects were approved for \$1,806,860 in cost-share funding. One of the five projects is a demonstration of GSHPs on Long Island.



The Project had two purposes; the first was to validate the installation and operating costs, as well as customer savings, for GSHPs with underground heat exchangers shared between multiple customers or housing units.<sup>10</sup> This objective also included an analysis of the benefits to the gas utility, principally in terms of a potential gas demand growth management tool. The second objective was to use the experience and knowledge gained to evaluate potential opportunities to accelerate the adoption of GSHPs.

## 1.2 Technical Overview

GSHPs are a highly efficient, commercially available heating and cooling technology that provides many benefits to the consumer, the gas and electric utilities, and the environment. GSHPs typically utilize conventional, vapor-compression heat pumps with conventional refrigerants. GSHP technology harnesses the near-constant temperature of the subsurface ground (up to 500 feet below the surface)<sup>11</sup> as a heat source or sink for space heating and space cooling. By exchanging the heat from the ground, GSHPs can effectively reach a COP in the heating mode of between 3.0 to 6.0, which represents efficiencies between 300% to 600%. This is achieved by using one unit of electricity to drive the heat pump while extracting three to six units of energy from the ground. Due to the high COPs that can be achieved, GSHPs use less energy than conventional heating and cooling equipment, therefore providing consumers with lower lifecycle costs and greater energy savings.

There are several design variations of the underground heat exchanger in current GSHP installations. The design and installation approach of these heat exchangers can vary based on site conditions, budget, and local drilling resources. Typical underground heat exchangers in current installations can be one of the following:<sup>12</sup>

- Closed-loop systems which use a ground loop (typically constructed of the same polyethylene flexible tubing as natural gas pipes) that circulates water and an antifreeze solution to exchange heat with the ground. Closed-loops can be installed in a horizontal or a vertical configuration based on site conditions.
- Open-loop systems which require a water source (often an aquifer) to extract or reject heat. This method reduces the installation cost because less piping is required, but its applicability is highly dependent on site conditions.
- Direct exchange systems which circulate a refrigerant through underground copper pipes, instead of an environmentally-safe water solution. Though direct exchange systems are

---

<sup>10</sup> When GSHP underground heat exchangers are shared among multiple customers or housing units through a common loop field, this is also referred to as a district loop piping system.

<sup>11</sup> NYS law does not require pre-notification or a well completion report for closed-loop geothermal systems with boreholes drilled up to 500 feet deep below grade. Geothermal wells over 500 feet deep below grade are regulated by the New York State Department of Environmental Conservation's Division of Mineral Resources. Additional information is available at <https://www.dec.ny.gov/lands/61176.html>

<sup>12</sup> New York State Energy Research and Development Authority. Renewable Heating and Cooling Policy Framework: Options to Advance Industry Growth and Markets in New York. Albany: NYSERDA, February 7, 2017.

highly efficient at heat extraction and rejection, the greenhouse gas emissions potential of refrigerants makes this option unattractive.

The concept of a shared community loop is not foreign to the geothermal industry. However, only a handful of installations have adopted the concept. Whisper Valley is a planned community in Austin, Texas, that features private homes with GSHPs connected to a shared community underground heat exchanger.<sup>13</sup> Drake Landing Solar Community is another planned community in the Town of Okotoks in the Province of Alberta, Canada, utilizing a combination of rooftop solar photovoltaic, heat pumps, a low-temperature district loop, and borehole thermal energy storage to achieve net-zero emissions.<sup>14</sup> The concept of GSHP shared loops in a private development may be easier to deploy, given that the developer or the community association owns and maintains the right-of-way. Although the benefits of shared community loops have not been widely studied, load diversity and load sharing can be observed between buildings, which can lead to a reduction of the loop capacity needed and cost reductions.

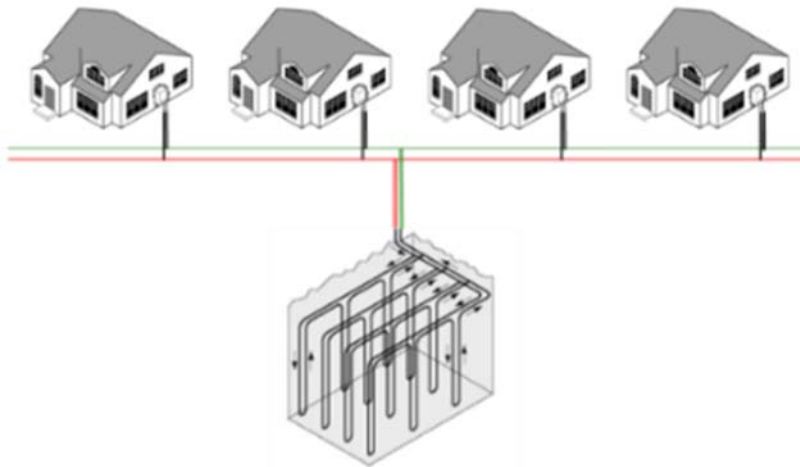


Figure 2. A GSHP design concept for a shared, central ground-loop heat exchanger. This design approach was implemented for the Project's Glenwood Village Site.

## 2.0 Project Roles and Responsibilities

The Project was a unique learning opportunity for the Company to gain first-hand experience with GSHPs. Given National Grid's limited experience with the technology, the support of stakeholders and service providers was critical for enabling the Project to be successful. The entities involved in the Project are as follows.

**Homeowners and landlords** were project participants. Glenwood Village is a privately-owned manufactured home community where the property owners (*i.e.*, landlords) own the entire parcel of land and lease building lots to individual homeowners. This site was chosen, in part, because the ownership model allowed the Project to simulate the service to individual private homes without using the public right-of-way that is not yet available to shared geothermal systems in the way that existing utility infrastructure can utilize a public right-of-way under its franchise rights.

<sup>13</sup> See <https://www.whispervalleyaustin.com/>

<sup>14</sup> See <https://www.dlsc.ca/>

At Glenwood Village, the community park where the underground heat exchanger is located is maintained by the landlords. The individual homeowners are the heat pump beneficiaries who agreed to allow the Company to replace their existing heating and cooling equipment with GSHPs. In contrast, at the Medford Site the underlying property and the building are commonly owned which is typical for existing geothermal systems on Long Island. The Association for Mental Health and Wellness is the property owner and United Way of Long Island was the developer for the veterans home. Easements were obtained with both property owners to allow the Company to provide ongoing maintenance should the need arise. All homeowners became residential customers of the Company upon the commissioning of the heat pump. Homeowners paid a fixed monthly access fee of \$21.66, which is the minimum charge of a KEDLI residential heating customer (Rate Code 140).

**NYSERDA** partnered with the Project to conduct EM&V and data collection for all eleven heat pump installations. The data collected focused on determining energy bill savings and the performance of GSHPs. National Grid also worked collaboratively with NYSERDA to use the data collected to evaluate several potential market support strategies that could overcome current market barriers. Furthermore, NYSERDA contributed to funding the EM&V scope. The Project also provided NYSERDA with a larger GSHP sample size to complement another GSHP performance validation demonstration project co-funded by PON 3127, consisting of 36 GSHPs.

**PSEG-LI** partnered with the Project to provide access to its energy efficiency programs. PSEG-LI recognizes the benefits of GSHPs to its electric grid and is supportive of programs that would increase GSHP adoption within their footprint and has been offering a GSHP energy efficiency program for several years as well as a discounted electric rate for electric heating. PSEG-LI additionally provided energy efficiency incentives towards weatherization improvements for homes participating in the Project with airtightness concerns.

**GEO-National & International Initiative (“GEO-NII”)** supported the Project by offering technical and advisory support in identifying suitable GSHP host sites. Also, GEO-NII attended multiple site evaluations and participant meetings at no cost to National Grid or the Project to encourage participation in the Project.

**New York Geothermal Energy Association (“NY-GEO”)** supported the Project with technical expertise and identifying potential qualified contractors within their network.

**Miller Environmental Group, Inc. (“MEG”)** and **ZBF Geothermal, LLC** were the qualified installation contractors hired to install GSHPs on a design-build basis at the Glenwood Village Site and the Medford Site. MEG was selected through a competitive bid process. ZBF Geothermal was selected in partnership with NYSERDA and alignment with PON 3127 requirements.

**United Way of Long Island** was initially approached by National Grid to identify suitable standalone homes to participate in the Project. In partnership with the property owner of the Medford veterans home, the Association for Mental Health and Wellness, an additional site was acquired for the Project.



**Frontier Energy, Inc. and Owahgena Consulting, Inc.** were jointly hired by the Company and NYSERDA to provide data acquisition, evaluation, and performance validation for the homes at the Glenwood Village Site.

**The GreyEdge Group** was the independent provider of certified geothermal inspection services to oversee critical elements of the installation.

**American AWS Corp.** was the approved weatherization provider hired by individual homeowners to improve building airtightness and building envelope energy efficiency and is a pre-approved provider of such services by PSEG-LI.

### 3.0 REV Goals Supported

The Project met several REV goals, as below noted in Table 2 below.

Table 2. REV Goals Supported by the Geothermal Gas REV Demonstration Project.

REV Goal	Supported by Project?	
	Yes	No
<b>Make energy more affordable</b>	X	
<b>Build a more resilient energy system</b>	X	
<b>Empower New Yorkers to make more informed energy choices</b>	X	
<b>Create new jobs and business opportunities</b>	X	
<b>Improve New York’s existing initiatives and infrastructure</b>	X	
<b>Support cleaner transportation</b>		X
<b>Reduce greenhouse gas emissions 80% by 2050</b>	X	
<b>Protect New York’s natural resources</b>	X	
<b>Help clean energy innovation grow</b>	X	

The most prominent REV goal supported by this Project is to ‘build a more resilient energy system’ by exploring whether GSHPs can be introduced in an efficient mix of resources on the energy system. The Project also tests whether GSHPs can be an ‘affordable’ alternative to home heating and cooling as an ‘energy choice’ compared to traditional heating fuels. Through learning opportunities, the Company hopes to play a role in accelerating the adoption of this ‘clean energy innovation,’ supporting ‘existing GSHP initiatives,’ and to improve the New York ‘energy infrastructure.’ In addition to protecting ‘New York’s natural resources,’ as previously stated, the Project and key findings align with National Grid’s effort to test, scale, and deploy clean energy solutions in line with its *Northeast 80x50 Pathway*, its net-zero by 2050 ambitions, and the State’s greenhouse gas emissions reduction target of net-zero 2050.

### 4.0 Project Key Findings

GSHP system installation commenced at the Glenwood Village Site in September 2017. Eight GSHPs were operational by December 2017. The last two GSHPs were installed in April 2018 because the new home itself was not sufficiently completed to accept the GSHP installation until that time. Data collection began in late December 2017 for eight of the ten homes and yielded several high-level key learnings throughout the Project. National Grid has filed quarterly reports

for the Project with the PSC through Q3 2019 and the Q4 2019 report provided in Appendix E to this report. Each quarterly report includes a listing of the lessons learned that quarter. These learnings are summarized as follows:

**Heat Pump Performance** – The American Heating Refrigeration Institute (“AHRI”) published rating for the heat pumps deployed for the Project which are summarized in Table 3 below. These ratings are developed under standardized laboratory conditions with controlled environments. The real-world performance will differ from the rated performance values and will generally perform lower due to environmental conditions and other factors. The Glenwood Village Site participants utilized two different configurations of GSHPs based on available space: (1) a packaged system where the heat pump compressor and air handler are inside the home, and (2) a split system where the major components are outside the home. The split systems are less efficient compared to packaged units; however, the difference is small. The average rated efficiency for the split systems is COP of 3.95, and the average rated efficiency for the packaged system is COP of 4.40. The average seasonal heating COP measured at Glenwood Village was 2.83. The measured performance efficiency illustrates an approximate 28% lower efficiency compared to the average split system AHRI ratings. As described in the EM&V report, the data shows the reduction of performance can be attributed to differences in ductwork, differences in pump power, and the GSHP configuration. The Project did make minor commissioning adjustments, such as changes in fan speed in 2018, to optimize system performance. However, adjustments were made with customer preference and comfort as the top priority.

Along with the varying building characteristics of each home, it was expected that each home would have different performance results. These learnings also emphasize the importance of data collection and performance validation with GSHPs to ensure systems performs.

Table 3. Summary of the AHRI Equipment Performance Rating for Project’s GSHPs

<b>Systems Installed</b>	<b>Heating COP Full / Part</b>	<b>Heating Capacity (MBtu/h) Full / Part</b>	<b>Cooling EER (Btu/Wh) Full / Part</b>	<b>Cooling Capacity (MBtu/h) Full / Part</b>
<b>Glenwood Village Split System (Hydron Module HRT036)</b>	3.7 / 4.2	27.4 / 21.8	16.0 / 24.5	35.5 / 27.6
<b>Glenwood Village Packaged System (Hydron Module HXT036)</b>	4.2 / 4.6	29.2 / 23.2	18.3 / 27.0	38.9 / 29.9
<b>Medford Site Packaged System (WaterFurnance® 7 Series)</b>	3.5 / 5.3	32.0 / 13.0	22.0 / 37.00	32.0 / 13.0

**Ground Loop Performance** – The GSHP system installed at the Glenwood Village Site was designed in accordance with the local geology. Data shows the underground heat exchanger performed well beyond the design parameters during the two heating and cooling seasons. The stated design parameters were 37°F as the minimum temperature and 80°F maximum for heating and cooling, respectively. In observation, the underground heat exchanger rarely went below 45°F in the winter and rarely exceeded 70°F in the summer. This difference between design parameters and operation parameters suggests there is unused system capacity which could be utilized to serve additional homes, which would otherwise be untapped in single loop configurations. Additionally, 80% of load diversity at peak thermal loads was observed at Glenwood Village. In other words, no more than 80% of peak heat pump nameplate heating load occurred at any point in time. Despite the apparent similarity of the participants, this illustrates the potential for downsizing the underground heat exchanger and improved GSHP performance, which can lead to cost savings if load diversity could be appropriately considered during design.

**Energy Cost Savings** – Glenwood Village participants experienced annual heating and cooling bill savings between \$341 to \$1,037, ranging from 31% to 60%. This confirms the energy saving benefits of GSHPs to reduce heating and cooling costs and improve energy affordability. A breakdown of heating and cooling savings calculations summarizes cost savings for each participant in Table 25 of Appendix D to this report.

**Additional Comfort Delivered** – Glenwood Village participants made several comfort-related comments after several months of usage compared to their traditional heating and cooling systems. It is important to note that during the data collection period, the outdoor temperature measured as low as 6°F (well below the 15°F “Manual J” design temperature conditions) with no heating issues. The prominent feedback was noise reduction. A simple decibel (“dB”) phone app was used to measure noise levels before and after the retrofit at Unit 5. The GSHP measured 68 dB while the original kerosene furnace measured 85 dB, a threefold loudness reduction.<sup>15</sup> Additionally, several participants favored GSHPs because of the improved air purification, ease of use, and even distribution of conditioned air.

**Construction Similarities** - Multiple National Grid group representatives visited the Glenwood Village Site to gain firsthand knowledge. Those groups included Environmental, Construction and Maintenance, Safety, and Engineering. The Company observed many similarities between the installation methodology and carrier products (pipes and valves) which are used to transport natural gas and geothermal energy. Specifically, many pipe fusion techniques utilized in geothermal construction are a near mirror image of the techniques used today in the natural gas distribution business. These include butt fusion, electrofusion, and saddle joining for branching.

**Efficiency Loss in Retrofit Applications** – Age of the building and existing building conditions can affect GSHP performance. Upon completion of the initial home assessment of participating homes at the Glenwood Village Site, older homes in some cases had uneven or inadequate air

---

<sup>15</sup> A decibel scale is logarithmic and not linear.

distribution, leaky ductwork, and air leakage in excessive of 20 air changes per hour.<sup>16</sup> It is important to note that similar manufactured homes utilize lost heat in the crawl space to keep a moderate temperature to prevent water pipes and drains from freezing. Though extensive weatherization improvements were made to those affected homes, issues such as the existing ductwork could only be improved and not resolved entirely unless replaced with new ductwork. No participants opted to replace their existing ductwork. This resulted in additional energy consumed and a reduction in overall system performance. Even with these efficiency penalties, participants enjoyed, on average, 35% savings on heating costs alone compared to historic fuel costs. Based on the two-year propane and kerosene savings, the projected participant savings averaged 43%, as shown in Table 4 below. This translates to significant savings potential for delivered fuel customers.

Table 4. Energy Bill Savings for Operating GSHPs Compared to Base Heating and Cooling Technology.

Unit	Base Fuel	Base Furnace Costs <sup>17</sup>	GSHP Heating Costs	Heating Cost Savings	Base A/C Cooling Costs	GSHP Cooling Costs	Cooling Cost Savings	Total Savings	Total % Cost Savings
HP1	Propane	\$1,521	\$843	\$677	\$236	\$224	\$12	\$689	39%
HP2	Propane	\$1,518	\$632	\$886	\$505	\$354	\$151	\$1,036	51%
HP3	Propane	\$1,302	\$426	\$877	\$435	\$275	\$160	\$1,037	60%
HP4	Propane	\$1,231	\$600	\$631	\$367	\$338	\$29	\$661	41%
HP5	Kerosene	\$805	\$499	\$306	\$118	\$83	\$35	\$341	37%
HP6	Kerosene	\$1,357	\$914	\$443	\$216	\$164	\$52	\$495	31%
HP7	Kerosene	\$1,184	\$545	\$639	\$255	\$152	\$103	\$742	52%
HP8	Kerosene	\$1,426	\$843	\$583	\$69	\$60	\$9	\$592	40%
HP9	Kerosene	\$812	\$457	\$355	\$219	\$159	\$60	\$415	40%
HP10	Kerosene	\$958	\$518	\$440	\$347	\$233	\$114	\$554	42%
<b>Totals</b>		\$12,114	\$6,277	\$5,837	\$2,767	\$2,042	\$725	\$6,562	Average 43%

Note: Average fuel costs are \$3.19/gal for propane and \$3.62/gal for kerosene. Propane costs shown are the average for Long Island for 2018-2019. Kerosene costs are the average statewide for 2018-2019. Heating costs are \$0.21/kWh for base case (LIPA Rate 180) and \$0.19/kWh for GSHP case (LIPA Rate 580). Base fuel use was calculated from the measured heating load using propane factors of 92 MBtu/gal and 78% efficiency and kerosene factors of 134 MBtu/gal and 81% efficiency. The base cost assumes a 200 kWh for annual fan use. The average fuel costs for 2018 and 2019 were calculated using the average monthly fuel prices obtained from NYSERDA

<sup>16</sup> 2016 Energy Code of New York State and 2016 Residential Code of New York State require that dwelling units be tested and verified as having an air leakage rate not exceeding three air changes per hour for new residential construction. Source: Section N1102.4.1.2 of the 2016 Residential Code of New York State.

<sup>17</sup> See NYSERDA Energy Prices and Weather Data available at <https://www.nyserdera.ny.gov/Researchers-and-Policymakers/Energy-Prices>

during this period. Refer to Section 4.6 in Appendix D of this report for the detailed savings calculation.

## 5.0 Key Lessons Learned

Through this valuable test-and-learn demonstration at the Glenwood Village Site, National Grid gathered experience around the technology benefits, market potential, and customer preference for a renewable heating and cooling system. The Project also helped answer several key questions to determine whether GSHPs are a cost-effective and feasible alternative heating and cooling solution.

### 5.1 Shared Loop vs. Individual Loop

The use of shared underground heat exchangers between multiple GSHPs is novel with limited utilization in the geothermal industry. The Glenwood Village Site provided a unique learning opportunity to understand the benefits of this approach and to begin to develop best practices to optimize future installations. The shared design method may have resulted in a cost premium of approximately \$30,000 (as quoted by MEG) compared to ten separate individual loops. However, the EM&V results showed the underground heat exchanger measured peak loop load diversity of approximately 85% in the summer and 82% in the winter. The load diversity observed can imply there is unused capacity in the system to serve additional customers. If the size of the loop was reduced by the excess 15% capacity observed during the summer months and, as a simplification, it was assumed that the cost would correspondingly decrease, the cost for the shared system would have been reduced by \$25,875, nearly offsetting any premium for the shared loop. Based on the data from the Glenwood Village Site and conversations with vendors in the geothermal industry, National Grid believes that the design and installation of shared loops can be optimized such that the cost per connected home can be equal to or less than it would be if non-shared systems were deployed.

While load diversity was expected to be low at the Glenwood Village Site given similar residential homes, the data collected shows the average peak loads during the two years to be only 80% and 70% of the expected equipment loads. This confirms again that there are clear benefits to shared loop designs. Although the load diversity is less prominent in similar homes with similar load requirements, larger shared loop designs incorporating both commercial and residential loads may deliver extra benefits, including installation cost reductions. A summary of key benefits between the two designs is outlined in Figure 6 below. Additional analysis of the underground heat exchanger load diversity can be found in Section 4.4 in Appendix D of this report.

The traditional single-loop installation is a more straightforward approach and favored by installation contractors, given its simplicity in design. Compared to shared loops, single loop designs require less attention to supply and return lines. Single loop designs can also provide benefits due to their dedicated service because a leak in the system would not impact multiple homeowners.

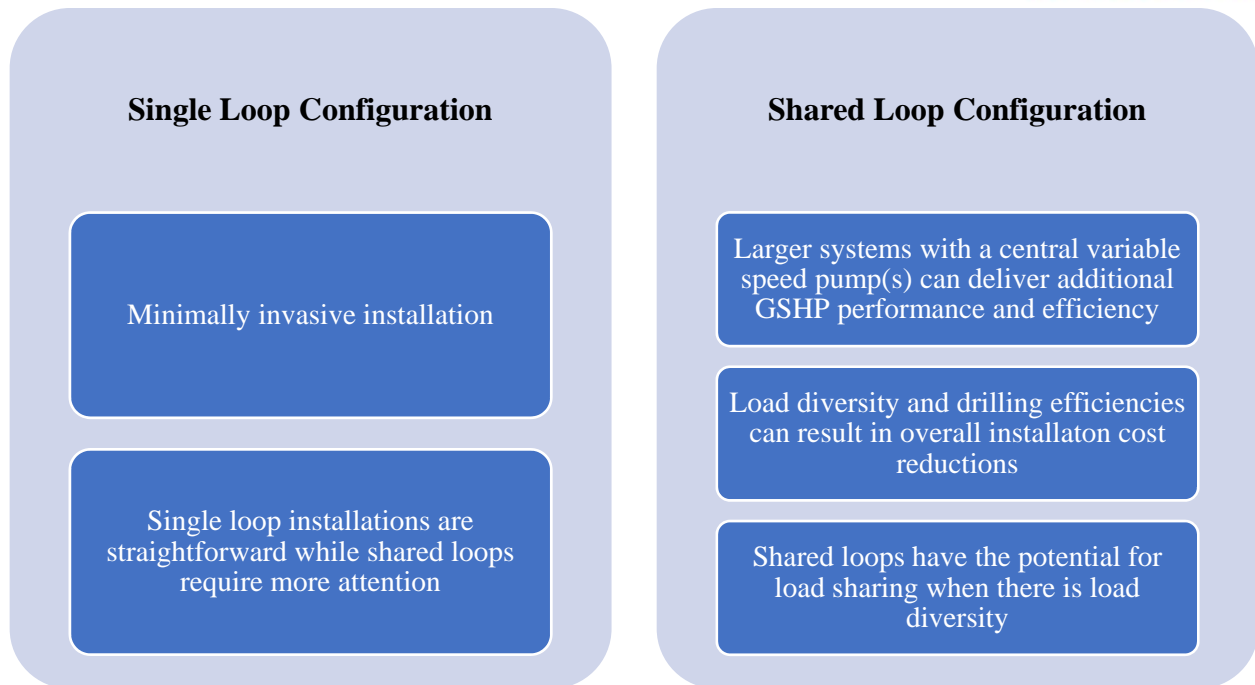


Figure 6. Key Benefits of Single Loop and Shared Loop Configurations.

## 5.2 The Advantages and Disadvantages when Multiple Homes Share a Common Underground Heat Exchanger.

There were many advantages observed using the shared common underground heat exchanger design at the Glenwood Village Site. First, installing a shared underground heat exchanger allows the ability for multiple heat pumps to contribute to the system and take advantage of load diversity. The peak load diversity measured at the Glenwood Village Site was 80%. This means no more than 80% of peak heat pump nameplate heating load occurred at any point in time, which can result in better overall GSHP performance than dedicated underground heat exchangers.

Second, installation cost efficiency was realized in installing ten GSHPs together. Installing a shared common underground heat exchanger and ten GSHPs resulted in mobilization and demobilization cost savings. Instead of ten separate individual trips, installing a shared common underground heat exchanger increases drill rig utilization and may reduce drilling costs. The mobilization and demobilization costs for the thermal conductivity test at the Glenwood Village Site was \$550 billed by MEG. By reducing the number of tests and coordinating the installation, the estimated savings for the Project was \$4,950.

Site limitations at Glenwood Village required the GSHPs to have individual water pumps as opposed to a centralized variable speed water pumping station. The ability to utilize a centralized variable speed pump house may deliver additional performance efficiencies. However, the construction of the pump house and ongoing maintenance increases costs. The EM&V report in Appendix D to this report highlights that additional capacity from individual homes can be combined to provide enhanced GSHP performance or the potential to serve additional participants. Though a shared loop may be more costly, the combined benefits of load diversity, enhanced



GSHP performance, and potential cost reductions of the underground heat exchanger may exceed the disadvantages observed.

### **5.3 GSHP Technology Can Be a Viable Option for Avoiding Incremental Peak Heating Load on the Gas Network**

GSHPs are a viable technology that can be designed to provide up to 100% of the heating load in residential settings. The GSHPs installed through this Project were explicitly designed to meet the peak heating and cooling loads of each house to mitigate the potential need for a backup system or reliance on electric resistance heating during peak winter conditions. As demonstrated, participants at the Glenwood Village Site were able to retire their traditional heating and cooling systems completely in favor of using efficient heating and cooling using GSHPs, and achieve significant energy bill savings. The Project findings confirm the technology as a viable technology to replace traditional HVAC systems. Furthermore, GSHPs can be a vital technology option for a natural gas utility to consider in areas with growing peak demand or constraints.

Gas system peak demand and gas constrained areas are different terminologies describing two different situations. However, the two are often related and locational specific. Deploying GSHPs in areas with growing peak demand, where the gas utility is experiencing times of supply constraint, mitigates the need for natural gas because GSHPs use electricity to provide up to 100% of the HVAC needs. Furthermore, if GSHPs are designed to meet all the heating loads, GSHPs will also improve the utilization of the electric grid when it is underutilized during the heating season. Deploying GSHPs in constrained areas, where the gas utility has reached the maximum safe connections given the existing pipeline infrastructure, also functions as a non-pipeline alternative (“NPA”), mitigating the need to build additional gas infrastructure because GSHPs will utilize the electric grid and energy stored in the ground.

Growing peak demand and gas constrained areas often occur in densely populated communities that are experiencing population growth along with increase in demand for natural gas. Urban environments present installation challenges in retrofit applications with the underground heat exchanger due to space constraints and the age of the building stock. Although innovative solutions are emerging in the drilling industry to drill in the basement of homes, getting the drill rig and other equipment into the basement may still present a significant challenge. In urban settings, installing underground heat exchanges in the public-right-of-way may be a feasible alternative. In contrast, this solution may not be necessary in suburban or rural settings, where the main road may be hundreds of feet away from the house, and more space is available for installation. Lastly, in all settings, the local geology plays the most crucial role in determining whether GSHPs are feasible and cost effective.

### **5.4 Price Points for Both the Traditional Geothermal Installations and Shared Common Loop Concepts**

The cost of the shared common underground heat exchanger at the Glenwood Village Site is approximately 60% of the system cost. Similarly, the cost of the traditional single underground heat exchanger at the Medford Site makes up a significant portion of the system cost, which accounts for approximately 45% (Table 5). In terms of cost per foot of total borehole depth at each project site, Glenwood Village has a higher cost because of the additional valves and pipe headers

required, specific to the design selected. Though there are additional costs associated with the shared common loop concept, the benefits of drilling cost efficiencies, load diversity, increased GSHP performance, and potential for downsizing the loop may outweigh these additional costs, as discussed later in this report. In summary, approximately half of the GSHP system cost is associated with the underground heat exchanger. This is a significant investment for a homeowner to make at the point of purchase, on top of the tangible heat pump unit. Described similarly by NYSERDA, heat pumps in general “require significant up-front investment for a residential system.”<sup>18</sup> Unless the total system cost of GSHPs becomes cost-competitive with traditional HVAC systems or the underground portion is eligible for long-term financing, the upfront cost of GSHPs will continue to be cost-prohibitive.

Table 5. GSHP Total System Cost at Glenwood Village and Medford Sites.<sup>19</sup>

Project Site	Geothermal Heat Exchanger	Heat Pump Equipment and Controls	Total Vertical Loop (ft)	Cost per vertical foot	Heat Pump and Heat Exchanger Cost	Cost Percentage of Heat Exchanger
<b>Glenwood Village Site (Ten GSHPs)</b>	\$172,500	\$116,000	4,700	\$36.70	\$288,500	60%
<b>Medford Site (Single GSHP)</b>	\$12,300	\$14,800	520	\$23.65	\$27,100	45%

### 5.5 Installation Challenges Observed during the Project

Retrofit applications for GSHPs may incur additional conversion costs, especially for manufactured homes where the utility closets are smaller compared to a boiler room in a single-family house. The size of a GSHP is generally larger than an oil or propane furnace. In the case of Glenwood Village, eight of the ten homes had to be retrofitted with split systems where the water pump and compressor unit were located outside of the home and connected to an air handler inside the home.

### 5.6 GSHPs Can Be a Viable Technology for a Gas Utility where Gas Service Is Cost Prohibitive

Customer demand for natural gas on Long Island has been strong for many decades. However, the cost of connecting to the gas network has prevented many Long Island customers from doing so. The customer contribution in aid of construction (“CIAC”) payment begins at \$10,000 for those who are 200 feet or more away from the gas network. The CIAC payment will increase as the distance from the gas network increases. GSHPs can meet the energy needs of customers and, in

<sup>18</sup> New York State Energy Research and Development Authority. Renewable Heating and Cooling Policy Framework: Options to Advance Industry Growth and Markets in New York. Albany: NYSERDA, February 7, 2017.

<sup>19</sup> The table does not consider system design or thermal conductivity test costs.



some cases, be more cost effective than connecting to the natural gas system. In situations where this is true, GSHPs can be a viable NPA and may result in cost savings for customers.

Using the cost data from the Medford Site, the cost of the underground heat exchanger begins to achieve cost parity at approximately 223 feet.<sup>20</sup> Homes further than 223 feet may find installing the underground heat exchanger to be less costly than connecting to the natural gas network. However, this does not necessarily infer that GSHPs are a more cost-effective alternative because the underground heat exchanger is only half of a GSHP system. As with customers connecting to the natural gas network, GSHP customers face the additional cost of installing above-ground equipment and potential in-home renovations.

The high upfront cost of the heat pump and the underground heat exchanger combined make GSHP technology economically disadvantageous at current market prices. The Company believes homes that are more than 200 feet away from the existing gas main will find GSHPs as a viable alternative to connecting to the gas network. When the heat pump portion achieves cost parity to conventional technology, along with third-party ownership models such as utility ownership of the underground loops, GSHP technology can overcome the first-cost barrier. Third-party ownership will increase the lifetime cost of the technology; however, the high upfront cost can be mitigated by spreading it out over the useful life of the underground loop. Furthermore, as the technology gains greater market share, additional cost reductions can be achieved through economies of scale.

NYSERDA estimates the upfront capital cost of fuel oil heating and central air conditioning equipment to be \$10,491.<sup>21</sup> The installed cost of the heat pump at Glenwood Village is \$11,600, only 9.5% higher. The Medford Site installed a WaterFurnance® 7 Series, a higher efficiency GSHP, which has a variable speed compressor and a variable speed water pump. The cost of the Medford Site's heat pump is approximately \$14,800, a 29% higher cost than counterfactual fuel oil and air conditioning systems. Though GSHPs are currently at a cost premium, the Company believes the installed cost of a heat pump can quickly achieve cost parity once market adoption increases.

## 5.7 Operating and Ongoing Maintenance Costs

The Project provided participants at Glenwood Village with two years of full equipment service through the installation contractor. During the Project term, no significant operating expenses occurred except for scheduled filter changes on the GSHP. Additionally, the GSHP comes with a 10-year equipment warranty and five years of labor allowance. The underground heat exchanger did not require any service during the Project term except for one occasion when the manifold flow sensor had to be repaired for data collection to resume in June 2018. The underground heat exchanger carries a 10-year full warranty through the installation contractor and 50 years with the manufacturer on the physical pipes itself. Overall, little to no ongoing operating costs are associated with the GSHP installed at the Glenwood Village Site. However, as with any

---

<sup>20</sup> Estimated based on \$100 per foot for 2-inch gas main and assumed the house requires less than 100 feet of service.

<sup>21</sup> New York State Energy Research and Development Authority. *New Efficiency: New York: Analysis of Residential Heat Pump Potential and Economics*. Albany: NYSERDA, January 2019.

operational underground asset, unforeseen circumstances like a digging accident could result in additional costs.

The Medford Site will also receive two years of full equipment service and the manufacturer's warranty through the installation contractor. The underground heat exchanger carries a manufacturer's warranty of 50 years with ten years of full warranty through the installation contractor.

### **5.8 Changes in Customer Heating and Cooling Costs**

As outlined earlier in Section 4, Project Key Findings, of this report, participants at the Glenwood Village Site experienced a minimum of 31% and a maximum of 60% total energy bill savings. Specifically, participants saved, on average, 48% (range of 33% to 67%) on space heating alone. Participants at the Glenwood Village Site experienced an average of 25% (range of 5% to 67%) in cooling savings. The wide range of cooling savings can be attributed to differences in individual cooling preferences. See Tables 26 and 27 within Appendix D of this report for a detailed breakdown of heating and cooling savings for each unit at Glenwood Village.

As described in Table 8 of Appendix D of this report, individual participants at Glenwood Village have different indoor temperature setpoints. Heating setpoints ranged from 61°F to 74°F and cooling setpoints ranged from 66°F to 75°F. These setpoint differences demonstrated load diversity amongst the participants and differences in heating and cooling needs, which can result in differences in energy bill savings.

### **5.9 The Cost for Individual Homeowners to Connect to the Gas Network**

The average distance of the ten homes at the Glenwood Village Site is approximately 1,500 feet away from the nearest gas main connection. The participant with the shortest distance is 850 feet, and the furthest is 2,077 feet. Based on 2018 market prices for new gas connections, it would cost approximately \$75,412 in customer CIAC payments for the nearest home to obtain a gas connection. It would cost approximately \$198,787 in customer CIAC payments for the furthest home. It is also important to point out that gas conversions require new natural gas appliances or equipment retrofits made by a licensed plumber. Perhaps, the cost of converting to natural gas for these ten project participants may have been the barrier to access the natural gas network.

Similarly, the Medford Site is approximately 1,600 feet away from the nearest gas main connection and would cost approximately \$160,000 in a customer CIAC payment.

The individual cost of a new gas main connection for these participants would be significant. Therefore, their economic alternative was using carbon-intensive delivered fuels as their heating solution. Comparing the unit GSHP cost of \$30,157 at Glenwood Village to the cost of obtaining natural gas, the economics show geothermal as the more cost-effective technology. The same argument can be made for the Medford Site, where the cost of installing the geothermal system was \$30,300.

### **5.10 Energy Derived from the Underground Heat Exchanger**

The total annual load observed at the Glenwood Village Site was 31,014 MBtu for heating and 11,861 MBtu for cooling. Using the average COP performance value, the estimated energy

extracted from the underground heat exchanger is 65%. This means for every unit of electricity to drive the heat pump, nearly three units of heat are extracted from the ground.

### 5.11 Key Differences between Rated Performance Values and Real-world GSHP Performance

The real-world performance efficiency of GSHPs is lower than the AHRI-rated performance values. AHRI ratings test GSHPs under a set of controlled operating conditions compared to field operating and user behaviors, which can decrease system performance. AHRI tests heating performance using entering indoor air temperature at 70°F (dry bulb),<sup>22</sup> while the actual indoor air temperature ranged from 61°F to 74°F (see Table 8 in Appendix D of this report). Additionally, older homes at Glenwood Village had inadequate or small diameter tin ductwork which required additional fan power to distribute conditioned air. Lastly, user input can also impact system performance, such as inducing reliance on auxiliary resistance heat by calling a significant setpoint increase observed with HP6 (see Table 23 in Appendix D of this report).

### 5.12 The Costs and Benefits of BTU Meters for Billing of Geothermal Service

The invoiced BTU meter unit cost for individual heat pumps is \$687.75. In comparison, the unit price of a residential gas meter is \$38.77. In addition to the equipment cost, additional component and labor costs to install the BTU meter is estimated at \$1,000.00. Given these price points, it may not be cost-effective to install BTU meters for customer billing purposes. Other billing methods can be used to bill customers for their use of the system, making the additional cost of BTU meters unnecessary.

Since GSHPs use the ground heat exchanger as the only source or sink for heat, there is virtually no commodity involved except for the electricity required to move energy to and from the heat exchanger. Furthermore, with the underground heat exchanger sized to meet all the heating and cooling loads based on the Manual J calculations, BTU meters may not be the cost-effective billing instrument.

Where BTU meters may be useful is to validate GSHP system performance as BTU meters can be used to provide valuable energy information to validate proper system operations. Additionally, BTU meters can also serve as a tool to keep track of changes in heating and cooling loads (*e.g.*, when a homeowner partitions a new section of the home such as a basement). The increased demand in heating and cooling requirements may have performance impacts and energy bill impacts.

BTU metering can be an essential and reliable method in other applications to bill for thermal energy, such as a low-temperature district heating and cooling system. Though district heating and cooling systems may be comprised of geothermal underground heat exchangers, district heating and cooling systems also utilize renewable energy such as solar heat, waste heat, and combined

---

<sup>22</sup>See 1998 Standard for Ground Source Closed-Loop Heat Pumps available at [http://www.ahrinet.org/App\\_Content/ahri/files/standards%20pdfs/AHRI%20standards%20pdfs/AHRI%20Standard%20330-1998.pdf](http://www.ahrinet.org/App_Content/ahri/files/standards%20pdfs/AHRI%20standards%20pdfs/AHRI%20Standard%20330-1998.pdf)

heat and power plants.<sup>23</sup> Under a real district system where BTUs can be created and injected into the distribution system, BTU metering and billing ensures that “BTU Owners” are compensated.

### 5.13 Estimated Carbon Savings Associated with the GSHP Installations

Driven by electricity, GSHPs do not burn fossil fuels to provide space heating but simply use electricity to move heat from the ground or use the ground as a heat sink in cooling mode. GSHPs can hypothetically achieve carbon-neutrality should the electricity from the grid be 100% renewable.

The estimate of the combined annual carbon savings for the ten participants at the Glenwood Village Site is 12.28 metric tons based on Long Island electric grid emissions (see Table 28 of Appendix D to this report). The real-world performance of GSHPs observed at the Glenwood Village Site resulted in a smaller than the expected 40% reduction in carbon savings described in the Project Implementation Plan because the GSHPs used more electricity. Also, electricity generation in the Long Island subregion has approximately 50% more carbon than the New York City/Westchester subregion and nearly 79% more carbon than the Upstate New York subregion (see Table 6 below). Despite the carbon intensity of the electric grid on Long Island, GSHPs still produce significant carbon savings. Glenwood Village participants reduced emissions by a range of 11% to 51%. The GSHP performance and runtime affect the overall carbon savings, resulting in a wide range. Over the expected 50 years of the life of the underground heat exchanger, the GSHP system at Glenwood Village will generate approximately 614 metric tons of CO<sub>2</sub> reductions, which is equivalent to taking 133 passenger vehicles off the road for one year.<sup>24</sup> A summary of the annual greenhouse gas reduction can be found in Table 28 of Appendix D to this report.

Table 6. Amount of CO<sub>2</sub> Produced during Electricity Generation in New York State by Subregion.<sup>25</sup>

Co2 Emissions by Subregion	Upstate NY	NYC/Westchester	Long Island
Pounds of CO <sub>2</sub> Equivalent per kWh	0.253	0.596	1.184

### 5.14 Participants Satisfaction with GSHP Installations

Overall, participants at the Glenwood Village Site exhibited satisfaction with GSHPs compared to the original HVAC systems. Participants did not find the heat pump installation process to be cumbersome or invasive compared to traditional HVAC systems.

All participants saved money operating on GSHPs compared to their traditional HVAC systems (see Table 5 in this report). However, the feedback received through customer surveys (see Section 5 of Appendix D to this report) showed a mixed perception of energy bill savings. Some

<sup>23</sup> Schmidt, D., Kallert, A., Blesl, M., Svendsen, S., Li, H., Nord, N., & Sipilä, K. (2017). Low temperature district heating for future energy systems. *Energy Procedia*, 116, 26-38.

<sup>24</sup> See EPA Greenhouse Gas Equivalencies Calculator available at [www.epa.gov/energy/greenhouse-gas-equivalencies-calculator](http://www.epa.gov/energy/greenhouse-gas-equivalencies-calculator)

<sup>25</sup> See EPA Power Profiler available at [www.epa.gov/energy/power-profiler#/NYLI](http://www.epa.gov/energy/power-profiler#/NYLI)

participants tend to associate higher electric bills to reduced energy bill savings without crediting the fuel costs they previously had to pay. Though the Project team encouraged participants to think based on a “total energy wallet” concept of combining traditional fuel delivery cost and electricity costs to pay for the new GSHP electricity cost, participants continued to be concerned about the electricity bill increases. Additional customer education, such as the analyses that can be completed with the fuel-switching calculator proposal filed by National Grid,<sup>26</sup> can be beneficial in scale-up programs to reduce the perception of the increased electric bill and overall GSHP energy bill savings.

Delivering adequate airflow in retrofit applications can be limited by the existing distribution system. At Glenwood Village, some homes required additional fan power to deliver appropriate airflow as requested by the participants. For most homes, fan speeds had to be increased in order to deliver airflow to all air vents. Though this may have adversely impacted the overall GSHP performance in some units, participants benefited from the improved airflow distribution. Feedbacks from the participant survey illustrated improved heating distribution in the winter and air conditioning in the summer.

Participants also voiced additional benefits delivered by GSHPs. These additional benefits include the reduced HVAC noise compared to a previous furnace and central air conditioning. Another benefit voiced by many is improved indoor and outdoor air quality. GSHPs run more often, cleaning the air more frequently as air passes through air filters. Many participants expressed relief that they no longer had to worry about fuel deliveries or the smell of kerosene. Since no fuel is burned to generate heat, the risk of carbon monoxide or combustion gases were significantly reduced (except for propane cooking). Lastly, the landlords of Glenwood Village were happy that there would be a reduction in fuel deliveries on the property, which decreases the potential risk of spills and accidents.

### **5.15 The Performance Impacts of Reducing Environmental Risk through Loop Design**

Field design differences can result in a reduction of GSHP performance. The design for the underground heat exchanger at the Glenwood Village Site and Medford Site used an environmentally friendly, biodegradable, and safe-to-handle freeze protection fluid. The systems were designed with 20% propylene-glycol, a more viscous fluid compared to the traditional freeze-protection fluid methanol. However, this design approach may reduce the GSHP performance of up to 10% under colder conditions. Considering the underground heat exchanger extends near the Magothy Aquifer, which is the primary drinking source for much of Long Island, the use of the safer option mitigates the risk of an environmental hazard.

In comparison, methanol provides the best combination of excellent heat transfer properties and pressure loss. However, methanol is associated with several physical and environmental risks.<sup>27</sup>

---

<sup>26</sup> See Cases 19-G-0310 *et al.*, *Proceeding on Motion of the Commission as to the Rates, Charges, Rules and Regulations of KeySpan Gas East Corporation d/b/a National Grid*, Direct Testimony of the Future of Heat Panel (filed April 30, 2019) in the context of National Grid’s rate case proceeding which is ongoing as of this report.

<sup>27</sup> Heinonen, E. W., Wildin, M. W., Beall, A. N., & Tapscott, R. E. (1998, March). Anti-freeze fluid environmental and health evaluation-an update. In *Proceedings of the Second Stockton International Geothermal Conference* (pp. 16-17).



### **5.16 Weatherization Improvements are Required in Most Retrofit Applications**

GSHPs usually provide a lower supply air temperature than combustion systems in forced-air heating systems and have been known to result in lower perceived comfort. Building characteristic differences at Glenwood Village introduced design challenges to ensure GSHPs would operate effectively and ensure comfort levels similar to or better than traditional heating and cooling systems. Upon initial site assessments, the Project team was concerned about the leakiness of homes and building envelopes. An initial home energy assessment and blower door test was performed for the five older homes under PSEG-LI's Home Energy Assessment Program. Extensive weatherization improvements such as spray foam, air sealing, and duct sealing were implemented to achieve approximately 30% to 40% air penetration reductions. Survey responses from Glenwood Village participants and performance data collected indicate that weatherization should be considered in advance of any GSHP retrofit installations.

### **5.17 The Size of the GSHP Industry in New York**

The geothermal industry in New York is relatively small compared to the number of traditional heating and cooling providers. While the above-ground components are nearly the same as conventional HVAC systems, the design and construction of the underground system require specialized certification and extensive experience. The industry experienced a reduction of providers shortly after the repeal of the Federal Residential Renewable Energy Tax Credit (also known as the federal investment tax credit ("ITC")) on December 31, 2016. The current GSHP market adoption rate of less than 1% of statewide HVAC load suggests a significant gap in the number of qualified GSHP installers today. Significant workforce development will be needed to achieve the minimum target of 3.566 TBtu in customer energy usage reduction through the deployment of heat pumps.<sup>28</sup>

### **5.18 The Key Professionals Involved in Installing GSHPs**

Generally, GSHP installations require a higher degree of coordination and communication between three separate accredited trade professionals consisting of the driller, engineer/designer, and the heat pump installer. The three parties must align construction activities in sequence to enable a harmonized customer experience. However, in most cases, the heat pump installer can take on the lead role and offer a design-build solution.

### **5.19 Operational Differences between Conventional HVAC Systems and GSHPs**

GSHPs operate differently than traditional HVAC systems, requiring additional education and training during the conversion process. A smart thermostat is required to control the GSHP and allow the system to operate effectively. The smart thermostat allows the system to stage the compressor cycle according to the indoor air temperature and the thermostat setpoint. Additionally, depending on the thermostat programming for stage three (or more in multi-stage systems) electric resistance, typically set at 10°F delta between thermostat setpoint and indoor temperature, homeowners can avoid reliance on auxiliary electric heat. Lastly, with GSHPs delivering warm air (90°F to 105°F) compared to the hot air (120°F plus) delivered by traditional HVAC systems, GSHPs are expected to have longer runtimes. Several participants worried that longer runtimes could result in more electricity use and higher electric bills. Through customer education and

---

<sup>28</sup> Case 18-M-0084, *supra* note 6.

training, participants learned about the performance efficiency and operating characteristics of the GSHP system. Later, participants noticed the comfort level created because warm air is moved frequently and evenly.

### 6.0 Cumulative Insights from Project

The insights gleaned through this first-hand experience are summarized in Table 8 below.

**Table 8. Summary of Major Insights.**

Cumulative Lessons Learned		
Project Participants	Market Partners	Utility Operations
<ul style="list-style-type: none"> <li>• Project participants widely exhibit a high satisfaction touting the plethora of added comfort-related benefits compared to their conventional systems.</li> <li>• Annual cost savings for participants at Glenwood Village ranged from \$341 to \$1,037 or 31% to 60%.</li> <li>• Minimal to no auxiliary electric heat was required for most homes during the 2019 heating season.</li> </ul>	<ul style="list-style-type: none"> <li>• GSHP represents less than 1% of the HVAC market; lack of volume increases overall cost in the current market.</li> <li>• There are a small number of qualified industry professionals; workforce development is vital to address as part of a market scale-up.</li> <li>• The industry is highly reliant on utility and government incentives. The market experienced a sharp reduction of GSHP installations when the federal ITC expired in 2016.</li> <li>• Utility backing and marketing can improve technology confidence and accelerate market adoption.</li> </ul>	<ul style="list-style-type: none"> <li>• Utility ownership of GSHP can reduce the upfront cost barrier and offer lower systems cost with scale. NYSERDA estimates an additional cost reduction of a minimum of 10% with utility ownership, through economies of scale.</li> <li>• Utility involvement can ensure that systems are correctly installed to promote durability and maximize system performance.</li> <li>• GSHP can provide an abundance of both electric and gas grid benefits if adequately designed and installed.</li> </ul>

### 7.0 Project Hypothesis Tested and Results

The Project successfully tested the hypotheses outlined in the Project Implementation Plan as depicted in Table 8 below.

Table 8. Project Test Statements.

Overarching Test Statement	
<b>GSHP is a technically and economically viable alternative for a gas utility to provide low-cost heating and cooling.</b>	<p><b>If...</b> National Grid installs a GSHP system to provide heating and cooling needs to participants...</p> <p><b>Then...</b> Participants will accept the technology and be receptive to installing GSHPs at their property.</p> <p><b>Results:</b> Project participants allowed National Grid to installed a GSHP at their residence. In retrofit applications, participants allowed National Grid to remove their existing equipment.</p>
	<p><b>If...</b> Participants heat and cool their homes at a more competitive cost using GSHPs than conventional heating (<i>i.e.</i>, fuel oil or electric heat) and cooling (<i>i.e.</i>, central or window air conditioning methods)...</p> <p><b>Then...</b> Participants would want to use GSHPs to heat and cool their homes.</p> <p><b>Results:</b> All ten participants benefited from heating and cooling savings.</p>
	<p><b>If...</b> GSHP systems can deliver heating and cooling at a competitive cost compared to bringing natural gas to an individual or grouped buildings where natural gas is not available...</p> <p><b>Then...</b> National Grid will evaluate offering GSHPs to homes and buildings with no access to natural gas.</p> <p><b>Results:</b> The Company wishes to offer GSHP and estimates customers who are more than 200 feet from a gas connection to be candidates for GSHP technology.</p>
Supporting Test Statements	
<b>1. A GSHP system produces a smaller carbon footprint than conventional heating (<i>i.e.</i>, fuel oil or electric heat) and cooling (<i>i.e.</i>, central or window air conditioning ).</b>	<p><b>If...</b>The operation of GSHPs produces fewer carbon emissions on a full-cycle basis than conventional heating and cooling equipment...</p> <p><b>Then...</b> GSHPs will support the State’s greenhouse gas emission reduction goals.</p> <p><b>Results:</b> Glenwood Village participants reduced emissions by a range of 11% to 51% with an annual carbon savings of 12.28 metric tons of carbon.</p>
<b>2. A GSHP system yields higher life-cycle energy savings to the participants.</b>	<p><b>If...</b> Participants experience energy savings of 30% or higher...</p> <p><b>Then...</b> GSHP technology is a cost-effective option for consumers to reduce heating and cooling costs and improve energy affordability.</p> <p><b>Results:</b> Participants saved 31% to 60% annually on heating and cooling costs compared to their traditional HVAC system.</p>
<b>3. GSHP provides electric peak load benefits and gas system benefits.</b>	<p><b>If...</b>GSHPs result in reduced electricity demand of 0.5 kW per ton of cooling...</p> <p><b>Then...</b>GSHPs can provide benefits to the electric grid system, reduce system costs, and potentially mitigate electric peaks.</p>



	<p><b>Results:</b> A recent NYSERDA study estimates GSHPs to reduce peak demand by 0.36 kW per ton of cooling.<sup>29</sup> Such a peak demand reduction is significant.</p> <p><b>If...</b> GSHPs can be deployed in unserved natural gas communities or gas constrained areas and reduce peak average residential customer demand by up to 100 cubic feet per hour...</p> <p><b>Then...</b> GSHPs can be used to defer potential capital commitments for gas utilities to reduce system costs and provide a viable option to mitigate peak demand growth for natural gas.</p> <p><b>Results:</b> GSHPs can provide all heating and cooling loads when appropriately designed following the Manual J load calculations. GSHPs can be deployed in underserved or gas constrained areas.</p>
<p><b>4. Project participants have higher customer satisfaction with GSHP systems.</b></p>	<p><b>If...</b> Project participants exhibit higher satisfaction after the Project evaluation period...</p> <p><b>Then...</b> GSHP technology is a favorable alternative to traditional systems (<i>e.g.</i>, higher cost oil or electric resistance heat).</p> <p><b>Results:</b> Participants exhibited overall higher satisfaction with GSHPs, along with additional comfort-related benefits.</p>

## 8.0 Project Cost Analysis

The Project cost of installing ten GSHPs and a common shared loop system at the Glenwood Village Site was \$307,070.75. With in-kind contributions by MEG, the net cost was \$301,570.75. It is important to note that a thermal conductivity test was needed for heat exchanger size of 30 tons or greater resulting in an added cost of \$8,571. The thermal conductivity test borehole was incorporated as one of the twenty boreholes. Additionally, due to different domestic hot water locations at each home, the GSHPs were not configured to provide domestic hot water. In terms of the cost per ton, the net cost confirms the current market price for geothermal at approximately \$10,000 per ton.

The Project cost of installing the single loop system at the Medford Site was \$30,300 which included domestic hot water service. A thermal conductivity test was not performed; instead, the geothermal designer used data from a nearby well to design the geothermal system. NYSERDA provided \$6,000 toward the Project for participation in NYSERDA’s PON 3127. Similarly, in terms of cost per ton, the market cost of geothermal is approximately \$10,000 per ton (Table 9).

<sup>29</sup> New York State Energy Research and Development Authority (NYSERDA). 2017. “Analysis of Water Furnace Geothermal Heat Pump Sites in New York State with Symphony Monitoring Systems” NYSERDA Report Number 18-03. Prepared by CDH Energy Corp., Cazenovia, NY. [nyserdera.ny.gov/publications](http://nyserdera.ny.gov/publications).

Table 9. System Cost Comparison between Glenwood Village and Medford Sites.

<b>Project Site</b>	<b>Glenwood Village Site (10 Retrofits)</b>	<b>Medford Site (Single New Construction)</b>
<b>Thermal Conductivity Test</b>	\$8,571	N/A
<b>Design</b>	\$10,000	\$1,250
<b>Geothermal Heat Exchanger</b>	\$172,500	\$12,300
<b>Heat Pump Equipment and Controls</b>	\$116,000	\$14,800
<b>Domestic Hot Water</b>	N/A	\$1,450
<b>2 Years of Full-Service Warranty</b>	Included	\$500
<b>Total Project Cost</b>	\$307,070.75	\$30,300.00
<b>System Size in Tons</b>	30	3
<b>Cost Per Ton</b>	\$10,236	\$10,100

NYSERDA provided significant contributions to the Project. In addition to the monetary contributions mentioned above, NYSERDA provided \$56,390 towards the EM&V work scope.

All eleven GSHPs participated in award-winning energy efficiency programs offered by PSEG-LI. PSEG-LI awarded the Project with \$61,100.02 for the Glenwood Village Site and approximately \$6,000 for the Medford Site. Also, PSEG-LI provided Project participants with a combined grant of \$15,815 towards weatherization improvements. These key Project cost elements, along with other Project costs, are summarized in Figure 6.

Cost Element	Thermal Conductivity Test	Design	Geothermal Loop System	Heat Pump Equipment and Controls	Domestic Hot Water	2-year Full Service Warranty	Project Total	Customer Contribution	Partner In-kind	Net Project Total	Notes
Glenwood Village - Miller Env (10 Units)	\$8,570.75	\$10,000.00	\$172,500.00	\$116,000.00	Not Applicable	Included	\$307,070.75	\$0.00	(\$5,500.00)	\$301,570.75	In-kind provided by Miller Environmental
Medford Project -ZBF Geo	Not Applicable	\$1,250.00	\$12,300.00	\$14,800.00	\$1,450.00	\$500.00	\$30,300.00	\$0.00	(\$6,000.00)	\$24,300.00	In-kind provided by NYSERDA PON 3127
Glenwood Village Oil Tank Abatement, Repairs							\$3,093.75			\$3,093.75	Miscellaneous repairs and proper waste disposal
Glenwood Inspection by CGI							\$5,927.38			\$5,927.38	Construction inspection by certified geothermal inspector
Project EM&V							\$100,780.00		(\$56,390.00)	\$38,462.62	In-kind provided by NYSERDA
Weatherization - PSEG-LI by AWS							\$25,292.00	(\$4,000.00)	(\$15,815.00)	\$5,477.00	In-kind provided by PSEG-LI's Energy Efficiency Program
Customer Geothermal Charge (\$21.66 per month)								(\$4,635.24)		(\$4,635.24)	Customer Monthly Access Charge
PSEG LI Rebate Glenwood									(\$61,100.02)	(\$61,100.02)	In-kind provided by PSEG-LI's Energy Efficiency Program
PSEG LI Rebate Medford Project									(\$6,000.00)	(\$6,000.00)	In-kind provided by PSEG-LI's Energy Efficiency Program
<b>Cost Element Totals</b>	<b>\$8,570.75</b>	<b>\$11,250.00</b>	<b>\$184,800.00</b>	<b>\$130,800.00</b>	<b>\$1,450.00</b>		<b>\$472,463.88</b>	<b>(\$8,635.24)</b>	<b>(\$150,805.02)</b>	<b>\$307,096.24</b>	
<b>National Grid</b>											
Project Land Survey and Travel Costs										\$9,035.24	
Project Management										\$114,657.10	
Total Project Spend										\$430,788.58	
Total Project Budget										\$450,000.00	
Variance										(\$19,211.42)	

Figure 6. Project Financials Broken Out by Cost Elements.

## 9.0 Key Conclusions

Through this demonstration project, National Grid installed eleven GSHPs in Long Island and gained first-hand experience along with valuable collected data and participant feedback. The Company is confident that the technology will continue to deliver energy savings for customers and will contribute to the State's energy goals. This experience has also shown that gas utilities can leverage GSHPs to provide heating service to interested customers in areas that are constrained, face growing peak demand, or are located too far from the gas network for economical connection. Although GSHPs are a proven technology and commercially available, the high upfront cost of purchasing two components, a GSHP unit and an underground heat exchanger, makes GSHPs inaccessible for many customers. Furthermore, unless the cost declines to a price point that is comparable to traditional HVAC systems or the cost of the underground heat exchanger is eligible for long-term financing, GSHPs will continue to face significant adoption challenges. The Company is evaluating strategies to lower the upfront cost of GSHPs for customers, detailed below. National Grid believes that utilities can play an enabling role in scaling this solution and delivering the customer, climate, and operational benefits that geothermal technology can provide.

Through this Project, the Company realized that the underground heat exchanger is akin to natural gas utility infrastructure in many ways. Both provide full-season heating solutions that are comprised of above-ground equipment (a heat pump, boiler, or furnace) and below-ground piping (a heat exchanger or natural gas infrastructure). In instances where multiple customers are connected to a shared loop, the geothermal system fulfills a similar function as the natural gas network, acting as a shared resource from which customers draw energy. If self-funding, customers face a high upfront cost with a long payback period. Although financing methods do not currently capture the value, underground heat exchangers and natural gas infrastructure share similar useful lives. Natural gas infrastructure and underground heat exchangers utilize similar installation methods, and GSHP systems could be more widely applicable in urban communities if they were able to be easily installed within public rights of way, similar to natural gas infrastructure. Due to these similarities, the geothermal industry may benefit from utility involvement. National Grid believes that there are opportunities to partner with the existing geothermal industry and leverage utility expertise to address the challenges that have stymied the growth of the geothermal industry to date.

## 10.0 Demonstrating Scaled Programs to Accelerate GSHP Adoption

The Project has provided the Company with a level of familiarity with GSHP, confidence in their performance, and an understanding of their potential applications. As the next steps, National Grid is interested in further evaluating the benefits of different shared loop configurations and how they can be deployed across the different types of communities served by the Company.

The Project results indicate that shared loop systems may provide unique benefits that result in cost savings, such as allowing for coordinated installation and reducing the overall size requirements of the underground heat exchanger. However, the Project provides a sample size of one, which limits the conclusions that can be drawn. The Company believes that additional shared

loop projects that focus on optimizing load diversity and application in urban areas would be useful in further exploring the value of shared loops.

Traditionally, utility involvement in the GSHP industry has taken the form of incentive programs. Although such programs help minimize the challenge of high upfront costs, National Grid believes more can be done to make this solution more widely available to customers. In particular, more needs to be done to reduce the first cost of these systems, shorten payback periods, increase public awareness, and address supply chain barriers through economies of scale. One promising business model to address the issue of high first costs and long payback period would be for the Company to own and maintain portions of the system, including the underground heat exchanger, the pump house (if required), and any associated equipment. This would be similar to the framework used by utilities for natural gas infrastructure, which allows for the recovery of the underground assets to be spread over the full useful life of those assets, thereby bringing down the upfront cost barrier faced by potential GSHP customers. This approach could complement the work done by the existing GSHP industry by allowing the utility to partner with geothermal drillers and qualified HVAC professionals to install the systems. The Company will continue to explore strategies for eliminating barriers to geothermal adoption, including the business model described above.

Appendix A  
Glenwood Village Site Design



---

## GSHP Design Report

Project: Stark Homes, Inc.  
Prepared: 27-Sep-2017

Prepared By: Tyler Harbeck



## Why Choose a LoopLink™ Certified Designer?

---

Choosing the right system designer for your geothermal heating and cooling system is a crucial first step to assuring your future comfort and long term financial savings.

LoopLink™ Certified Designers have recognized that a residential/light commercial geothermal system deserves the same attention to detail afforded to a commercial design. This ensures the lowest cost of operation, minimizes system maintenance and guarantees the highest level of comfort within your space over the life of the system.



By selecting a LoopLink™ Certified Designer, you can breathe easy knowing your designer:

- Has demonstrated a comprehensive understanding of residential and light commercial geothermal system design.
- Is trained and qualified in the use of LoopLink™ for the completion of design calculations and creation of design reports.
- Understands and can justify specific equipment selections and their impact on the performance of your geothermal system.

When choosing a geothermal system designer be sure to look for the LoopLink™ Certified seal. This symbol lets you know that your designer has been trained not just by the makers of the earth's best geothermal design software but by the authors of the industry standard Design and Installation Manual issued by the International Ground Source Heat Pump Association (IGSHPA).



## System Loads

System Loads or Peak Loads are calculated based on a variety of details for an individual residence. Assumed occupancy levels, the number of appliances operating, the number of doors & windows and the tightness of the construction all contribute to the amount of energy required to maintain the thermostat set points given the historical extreme weather conditions in your area.

The peak loads used in this report were provided as listed in the following table.

1 kBtu/hr = 1,000 Btu/hr

Zone	Total Heating Load (kBtu/hr)	Total Cooling Load (kBtu/hr)	Zone SHF
<b>156B</b>	<b>32.38</b>	<b>22.23</b>	<b>0.850</b>
<b>156C</b>	<b>35.84</b>	<b>23.39</b>	<b>0.860</b>
<b>164</b>	<b>32.38</b>	<b>23.19</b>	<b>0.860</b>
<b>165</b>	<b>32.38</b>	<b>23.19</b>	<b>0.860</b>
<b>168B</b>	<b>30.19</b>	<b>20.63</b>	<b>0.850</b>
<b>168C</b>	<b>34.85</b>	<b>22.97</b>	<b>0.850</b>
<b>361</b>	<b>38.61</b>	<b>23.94</b>	<b>0.850</b>
<b>362</b>	<b>34.29</b>	<b>22.66</b>	<b>0.850</b>
<b>363</b>	<b>35.06</b>	<b>23.13</b>	<b>0.850</b>
364	34.29	22.66	<b>0.850</b>
Total	<b>340.29</b>	<b>228.00</b>	

Equipment Schedule

Based on the provided loads, the recommended heat pump schedule for this system is as follows:

High Cap.  
Low Cap.

1 kBtu/hr = 1,000 Btu/hr

Zone	GSHP	QTY	Heat <sup>1</sup> Cap. (kBtu/hr)	Cool <sup>1</sup> Cap. (kBtu/hr)	Water <sup>2</sup> Flow (GPM)	Air <sup>3</sup> Flow (CFM)
156B	Hydron Module - Revolution HXT036 <b>or HRT036</b>	1	33.43	38.30	9.0	1,350
			25.70	30.00		
156C	Hydron Module - Revolution HXT036 <b>or HRT036</b>	1	33.43	38.30	9.0	1,350
			25.70	30.00		
164	Hydron Module - Revolution HXT036	1	33.43	38.30	9.0	1,350
			25.70	30.00		
165	Hydron Module - Revolution HXT036	1	33.43	38.30	9.0	1,350
			25.70	30.00		
168B	Hydron Module - Split HRT036	1	30.90	35.60	9.0	1,200
			-	-		
168C	Hydron Module - Split HRT036	1	30.90	35.60	9.0	1,200
			-	-		
361	Hydron Module - Split HRT036	1	30.90	35.60	9.0	1,200
			-	-		
362	Hydron Module - Split HRT036	1	30.90	35.60	9.0	1,200
			-	-		
363	Hydron Module - Split HRT036	1	30.90	35.60	9.0	1,200
			-	-		
364	Hydron Module - Split HRT036	1	30.90	35.60	9.0	1,200
			-	-		
High Capacity Totals			319.12	366.80	90.0	
Low Capacity Totals			102.80	120.00	-	

1. All capacities shown are total.
2. When applicable, hydronic equipment source and load water flows are assumed equal.
3. Air flow rates are reported on a per heat pump basis. For total air flow in a zone, multiply the reported air flow by quantity.

## Equipment Efficiencies

The following efficiencies are for air systems, hot water generation efficiencies can be found on the hot water generation page.

**NOTE:** GSHP efficiencies shown below are system wide averages which include pumping and applicable resistance energy. Efficiencies for individual GSHP zones can be found on the zone pages.

### Heating

GSHP (COP <sub>AVG</sub> )	3.72
Electric Resistance (COP <sub>H</sub> )	1.00
ASHP (HSPF)	6.00
Natural Gas (AFUE)	88.00%
Propane (AFUE)	90.00%
Fuel Oil (AFUE)	80.00%
Old GSHP (COP)	2.80

### Cooling

GSHP (EER <sub>AVG</sub> )	15.46
A/C (SEER)	15.00
ASHP (SEER)	15.00
Old GSHP (EER)	10.00

156B

Zone Details

The peak loads for each individual zone are used to calculate the total amount of heating & cooling capacity required for a space based on the set points and the climate data for your area.

Peak Heating Load 32,385 Btu/hr	Peak Cooling Load 22,232 Btu/hr
Heating Set Point 70 °F	Cooling Set Point 75 °F
Heating Offset 0 Btu/hr	Space SHF 0.850

GSHP Selection

The ground source heat pump below has been selected to maintain comfortable heating & cooling for this zone.

Manufacturer Hydron Module  
 Model Revolution HXT036

Heat Pump Type Water to Air	Capacity Dual Capacity # Heat Pumps 1
-----------------------------	---------------------------------------

Installed Capacity Check

The installed capacity check describes the efficiency and total heating/cooling capacity of the selected ground source heat pump system. This information is used to ensure proper sizing of equipment based on the load represented by this zone.

Heating (High Capacity)

Heating Capacity 33,430 Btu/hr  
 % Sizing 103.2%  
 % Energy From Geo 99.9%  
 Installed COP 4.20  
 Balance Point Temp. 9.8 °F

Heating (Low Capacity)

Heating Capacity 25,700 Btu/hr  
 % Sizing 79.4%  
 Installed COP 4.34

Cooling (High Capacity)

Total Cooling Capacity 38,300 Btu/hr  
 Sensible Cooling Capacity 28,725 Btu/hr  
 % Oversizing 52.0%  
 Installed EER 15.93

Cooling (Low Capacity)

Total Cooling Capacity 30,000 Btu/hr  
 Sensible Cooling Capacity 22,500 Btu/hr  
 % Oversizing 19.1%  
 Installed EER 21.90

156B

### Zone Operating Summary

The Zone Operating Summary describes equipment runtime and the total annual power consumption for the GSHP operating in this zone.

#### Heating

High Capacity Runtime 340 hrs  
 Low Capacity Runtime 1,900 hrs  
 Supplemental Bin Hours 26 hrs  
 Dual Fuel Bin Hours 0 hrs  
 Heat Pump Energy Use 4,094 kWh  
 Pumping Energy Use 315 kWh  
 Supplemental Energy Use 21 kWh  
 Dual Fuel Energy Use 0 ccf

#### Cooling

High Capacity Runtime 0 hrs  
 Low Capacity Runtime 737 hrs  
  
 Heat Pump Energy Use 1,045 kWh  
 Pumping Energy Use 103 kWh

### GSHP Operating Cost Breakdown for Zone Name

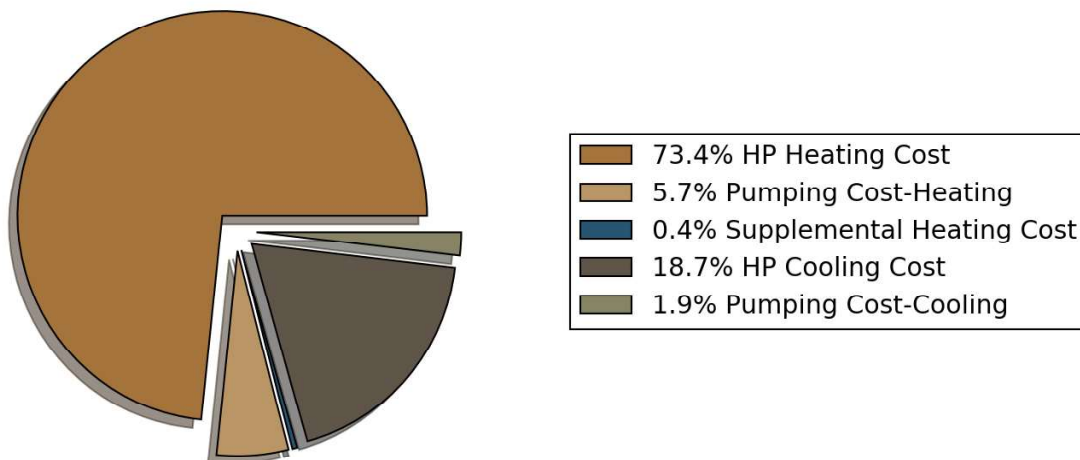
Based on the annual power consumption of the system and the price per kilowatt hour in your area the estimated cost to maintain the set points for this zone are as follows:

#### Heating

HP Cost \$818.90  
 Supplemental Cost \$4.35  
 Dual Fuel Cost \$0.00  
 Pumping Cost \$63.17  
  
 Total Cost \$886.42

#### Cooling

HP Cost \$209.14  
 Pumping Cost \$20.77  
  
 Total Cost \$229.91



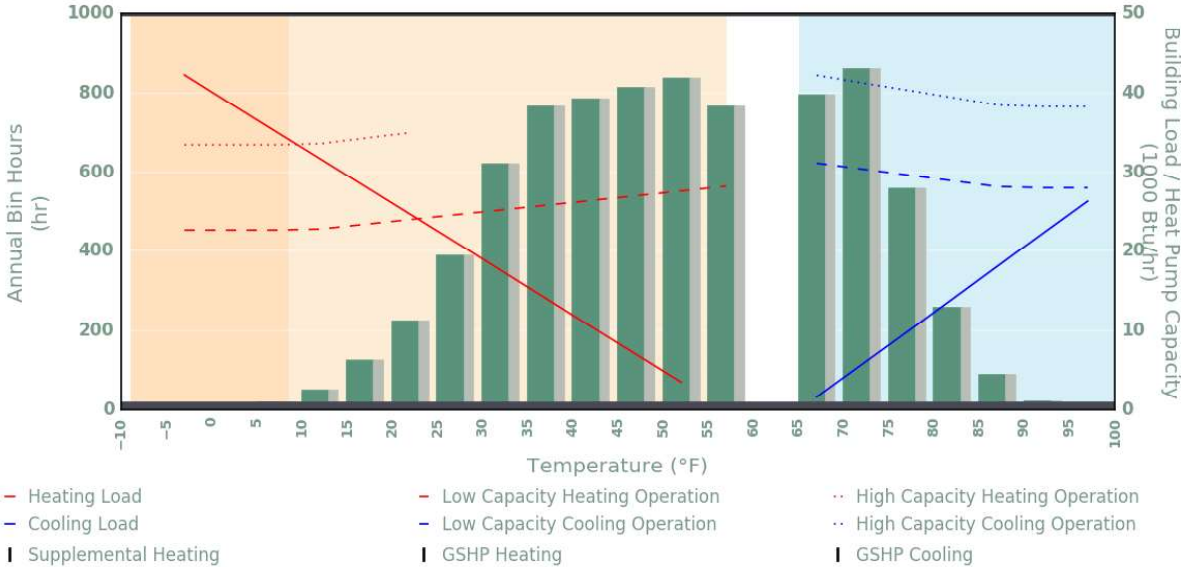
## Back-Up System Details

### Supplemental System Details

Supplemental systems operate at the same time as the geothermal heat pump and provide additional heat when the space load is greater than the system capacity.

Supplemental System Type **Electric Resistance** COP **1.0**

**Zone Load and Operating Profile**



### Heating

Heating Start OAT **57.0 °F**  
 High Capacity Runtime **340 hr**  
 Low Capacity Runtime **1,900 hr**  
 Supplemental Bin Hours **26 hr**

### Cooling

Cooling Start OAT **65.0 °F**  
 High Capacity Runtime **0 hr**  
 Low Capacity Runtime **737 hr**

156C

Zone Details

The peak loads for each individual zone are used to calculate the total amount of heating & cooling capacity required for a space based on the set points and the climate data for your area.

Peak Heating Load 35,842 Btu/hr

Peak Cooling Load 23,385 Btu/hr

Heating Set Point 75 °F

Cooling Set Point 72 °F

Heating Offset 0 Btu/hr

Space SHF 0.860

GSHP Selection

The ground source heat pump below has been selected to maintain comfortable heating & cooling for this zone.

Manufacturer Hydron Module

Model Revolution HXT036

Heat Pump Type Water to Air

Capacity Dual Capacity # Heat Pumps 1

Installed Capacity Check

The installed capacity check describes the efficiency and total heating/cooling capacity of the selected ground source heat pump system. This information is used to ensure proper sizing of equipment based on the load represented by this zone.

Heating (High Capacity)

Heating Capacity 33,430 Btu/hr

% Sizing 93.3%

% Energy From Geo 99.6%

Installed COP 4.20

Balance Point Temp. 13.6 °F

Heating (Low Capacity)

Heating Capacity 25,700 Btu/hr

% Sizing 71.7%

Installed COP 4.34

Cooling (High Capacity)

Total Cooling Capacity 38,300 Btu/hr

Sensible Cooling Capacity 28,725 Btu/hr

% Oversizing 42.8%

Installed EER 15.93

Cooling (Low Capacity)

Total Cooling Capacity 30,000 Btu/hr

Sensible Cooling Capacity 22,500 Btu/hr

% Oversizing 11.9%

Installed EER 21.90



156C

### Zone Operating Summary

The Zone Operating Summary describes equipment runtime and the total annual power consumption for the GSHP operating in this zone.

#### Heating

High Capacity Runtime 369 hrs  
 Low Capacity Runtime 2,090 hrs  
 Supplemental Bin Hours 75 hrs  
 Dual Fuel Bin Hours 0 hrs  
 Heat Pump Energy Use 4,491 kWh  
 Pumping Energy Use 346 kWh  
 Supplemental Energy Use 72 kWh  
 Dual Fuel Energy Use 0 ccf

#### Cooling

High Capacity Runtime 0 hrs  
 Low Capacity Runtime 773 hrs  
 Heat Pump Energy Use 1,097 kWh  
 Pumping Energy Use 109 kWh

### GSHP Operating Cost Breakdown for Zone Name

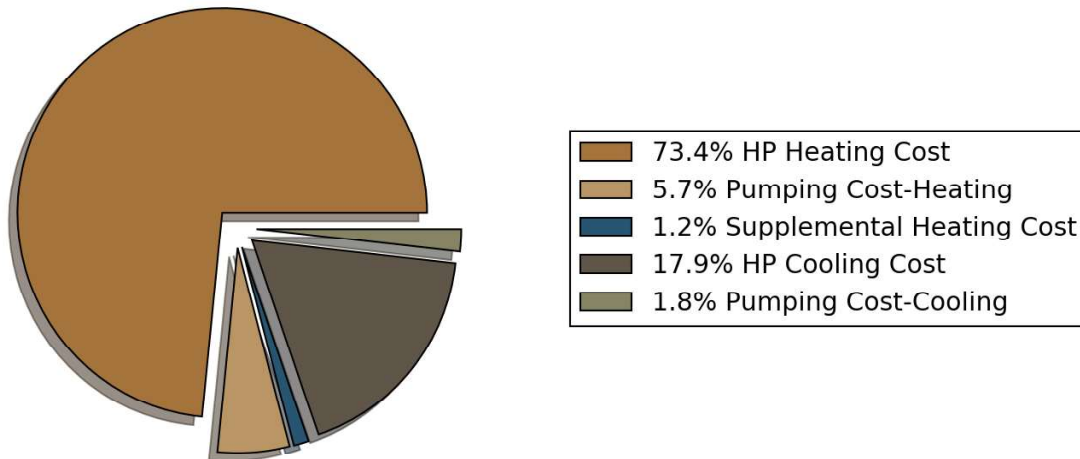
Based on the annual power consumption of the system and the price per kilowatt hour in your area the estimated cost to maintain the set points for this zone are as follows:

#### Heating

HP Cost \$898.30  
 Supplemental Cost \$14.54  
 Dual Fuel Cost \$0.00  
 Pumping Cost \$69.34  
 Total Cost \$982.18

#### Cooling

HP Cost \$219.48  
 Pumping Cost \$21.80  
 Total Cost \$241.28



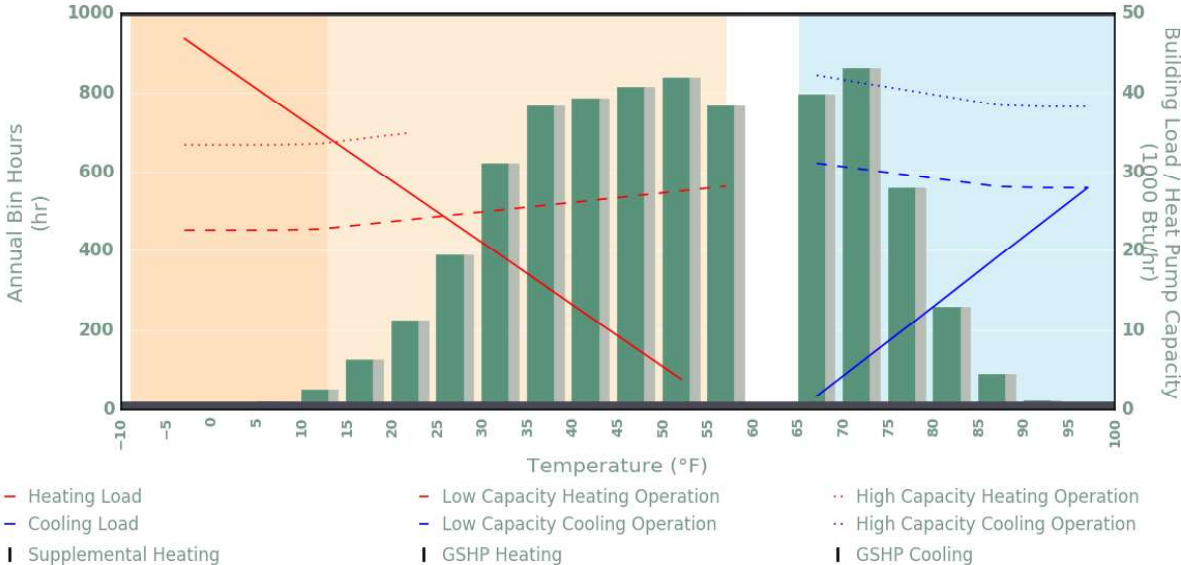
## Back-Up System Details

### Supplemental System Details

Supplemental systems operate at the same time as the geothermal heat pump and provide additional heat when the space load is greater than the system capacity.

Supplemental System Type **Electric Resistance** COP **1.0**

**Zone Load and Operating Profile**



### Heating

Heating Start OAT **57.0 °F**  
 High Capacity Runtime **369 hr**  
 Low Capacity Runtime **2,090 hr**  
 Supplemental Bin Hours **75 hr**

### Cooling

Cooling Start OAT **65.0 °F**  
 High Capacity Runtime **0 hr**  
 Low Capacity Runtime **773 hr**

Zone Details

The peak loads for each individual zone are used to calculate the total amount of heating & cooling capacity required for a space based on the set points and the climate data for your area.

Peak Heating Load 32,385 Btu/hr

Peak Cooling Load 23,193 Btu/hr

Heating Set Point 70 °F

Cooling Set Point 75 °F

Heating Offset 0 Btu/hr

Space SHF 0.860

GSHP Selection

The ground source heat pump below has been selected to maintain comfortable heating & cooling for this zone.

Manufacturer Hydron Module

Model Revolution HXT036

Heat Pump Type Water to Air

Capacity Dual Capacity # Heat Pumps 1

Installed Capacity Check

The installed capacity check describes the efficiency and total heating/cooling capacity of the selected ground source heat pump system. This information is used to ensure proper sizing of equipment based on the load represented by this zone.

Heating (High Capacity)

Heating Capacity 33,430 Btu/hr

% Sizing 103.2%

% Energy From Geo 99.9%

Installed COP 4.20

Balance Point Temp. 9.8 °F

Cooling (High Capacity)

Total Cooling Capacity 38,300 Btu/hr

Sensible Cooling Capacity 28,725 Btu/hr

% Oversizing 44.0%

Installed EER 15.93

Heating (Low Capacity)

Heating Capacity 25,700 Btu/hr

% Sizing 79.4%

Installed COP 4.34

Cooling (Low Capacity)

Total Cooling Capacity 30,000 Btu/hr

Sensible Cooling Capacity 22,500 Btu/hr

% Oversizing 12.8%

Installed EER 21.90

Zone Operating Summary

The Zone Operating Summary describes equipment runtime and the total annual power consumption for the GSHP operating in this zone.

Heating

High Capacity Runtime 340 hrs  
 Low Capacity Runtime 1,900 hrs  
 Supplemental Bin Hours 26 hrs  
 Dual Fuel Bin Hours 0 hrs  
 Heat Pump Energy Use 4,094 kWh  
 Pumping Energy Use 315 kWh  
 Supplemental Energy Use 21 kWh  
 Dual Fuel Energy Use 0 ccf

Cooling

High Capacity Runtime 0 hrs  
 Low Capacity Runtime 767 hrs  
 Heat Pump Energy Use 1,088 kWh  
 Pumping Energy Use 108 kWh

GSHP Operating Cost Breakdown for Zone Name

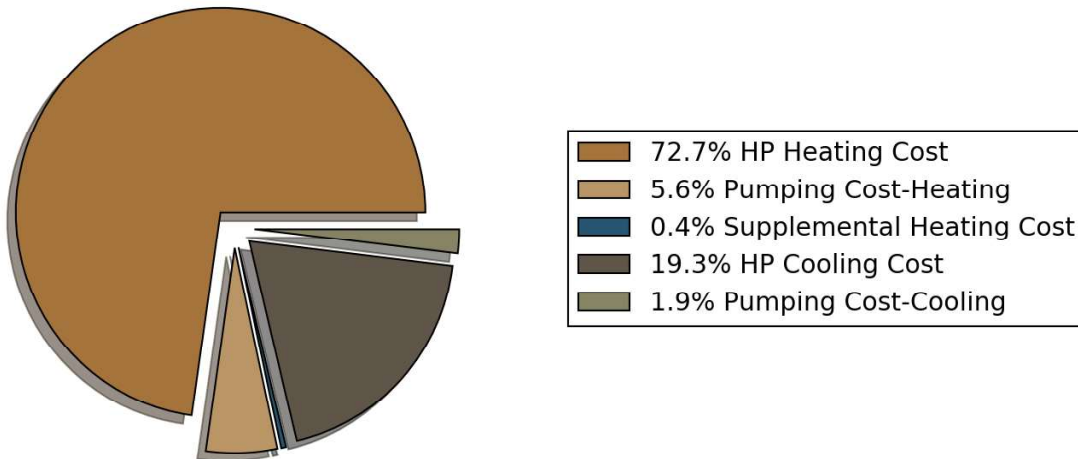
Based on the annual power consumption of the system and the price per kilowatt hour in your area the estimated cost to maintain the set points for this zone are as follows:

Heating

HP Cost \$818.90  
 Supplemental Cost \$4.35  
 Dual Fuel Cost \$0.00  
 Pumping Cost \$63.17  
 Total Cost \$886.42

Cooling

HP Cost \$217.76  
 Pumping Cost \$21.63  
 Total Cost \$239.39



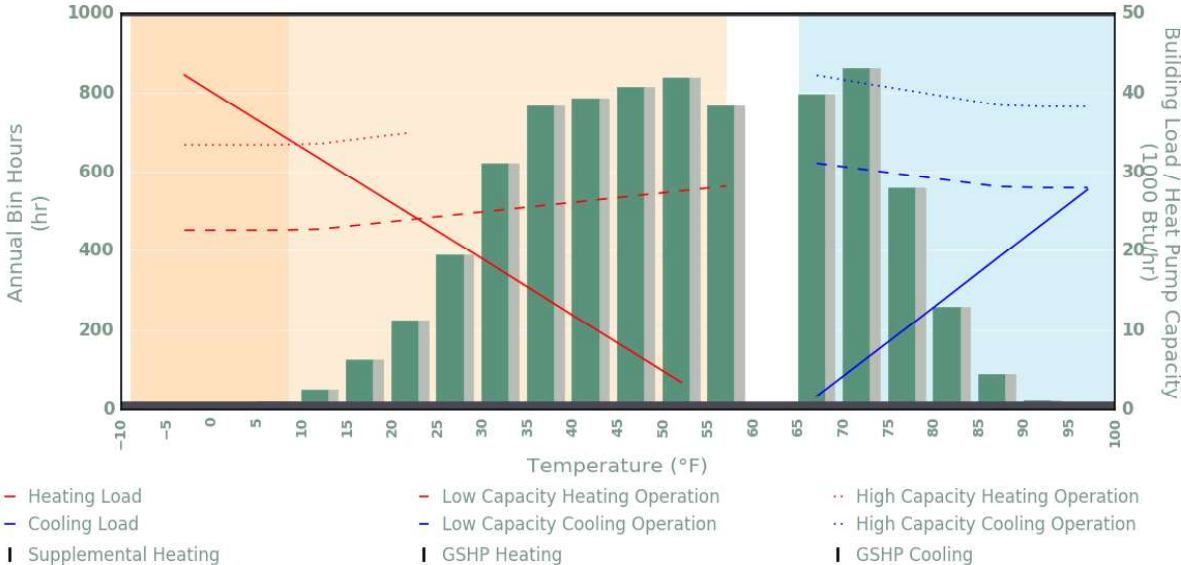
## Back-Up System Details

### Supplemental System Details

Supplemental systems operate at the same time as the geothermal heat pump and provide additional heat when the space load is greater than the system capacity.

Supplemental System Type **Electric Resistance** COP **1.0**

**Zone Load and Operating Profile**



### Heating

Heating Start OAT **57.0 °F**  
 High Capacity Runtime **340 hr**  
 Low Capacity Runtime **1,900 hr**  
 Supplemental Bin Hours **26 hr**

### Cooling

Cooling Start OAT **65.0 °F**  
 High Capacity Runtime **0 hr**  
 Low Capacity Runtime **767 hr**

Zone Details

The peak loads for each individual zone are used to calculate the total amount of heating & cooling capacity required for a space based on the set points and the climate data for your area.

Peak Heating Load 32,385 Btu/hr

Peak Cooling Load 23,193 Btu/hr

Heating Set Point 70 °F

Cooling Set Point 75 °F

Heating Offset 0 Btu/hr

Space SHF 0.860

GSHP Selection

The ground source heat pump below has been selected to maintain comfortable heating & cooling for this zone.

Manufacturer Hydron Module

Model Revolution HXT036

Heat Pump Type Water to Air

Capacity Dual Capacity # Heat Pumps 1

Installed Capacity Check

The installed capacity check describes the efficiency and total heating/cooling capacity of the selected ground source heat pump system. This information is used to ensure proper sizing of equipment based on the load represented by this zone.

Heating (High Capacity)

Heating Capacity 33,430 Btu/hr

% Sizing 103.2%

% Energy From Geo 99.9%

Installed COP 4.20

Balance Point Temp. 9.8 °F

Heating (Low Capacity)

Heating Capacity 25,700 Btu/hr

% Sizing 79.4%

Installed COP 4.34

Cooling (High Capacity)

Total Cooling Capacity 38,300 Btu/hr

Sensible Cooling Capacity 28,725 Btu/hr

% Oversizing 44.0%

Installed EER 15.93

Cooling (Low Capacity)

Total Cooling Capacity 30,000 Btu/hr

Sensible Cooling Capacity 22,500 Btu/hr

% Oversizing 12.8%

Installed EER 21.90

Zone Operating Summary

The Zone Operating Summary describes equipment runtime and the total annual power consumption for the GSHP operating in this zone.

Heating

High Capacity Runtime 340 hrs  
 Low Capacity Runtime 1,900 hrs  
 Supplemental Bin Hours 26 hrs  
 Dual Fuel Bin Hours 0 hrs  
 Heat Pump Energy Use 4,094 kWh  
 Pumping Energy Use 315 kWh  
 Supplemental Energy Use 21 kWh  
 Dual Fuel Energy Use 0 ccf

Cooling

High Capacity Runtime 0 hrs  
 Low Capacity Runtime 767 hrs  
 Heat Pump Energy Use 1,088 kWh  
 Pumping Energy Use 108 kWh

GSHP Operating Cost Breakdown for Zone Name

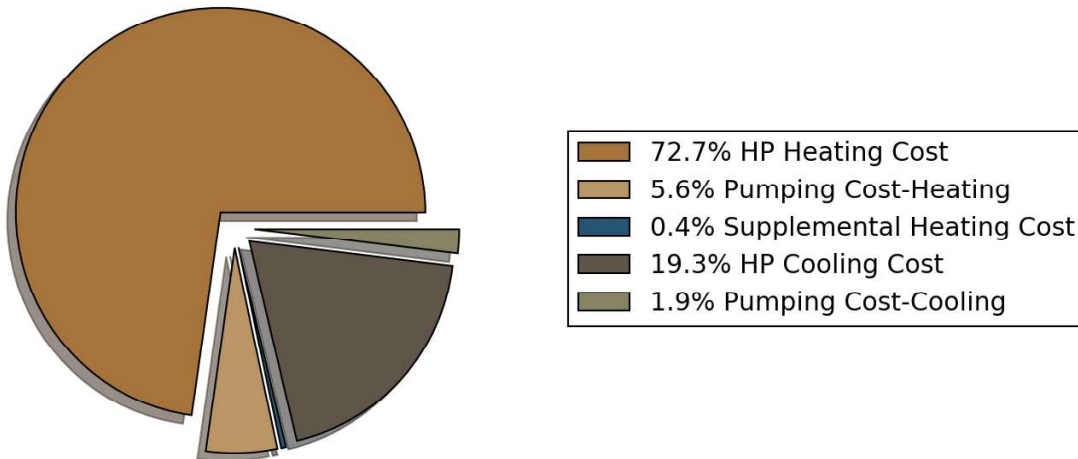
Based on the annual power consumption of the system and the price per kilowatt hour in your area the estimated cost to maintain the set points for this zone are as follows:

Heating

HP Cost \$818.90  
 Supplemental Cost \$4.35  
 Dual Fuel Cost \$0.00  
 Pumping Cost \$63.17  
 Total Cost \$886.42

Cooling

HP Cost \$217.76  
 Pumping Cost \$21.63  
 Total Cost \$239.39





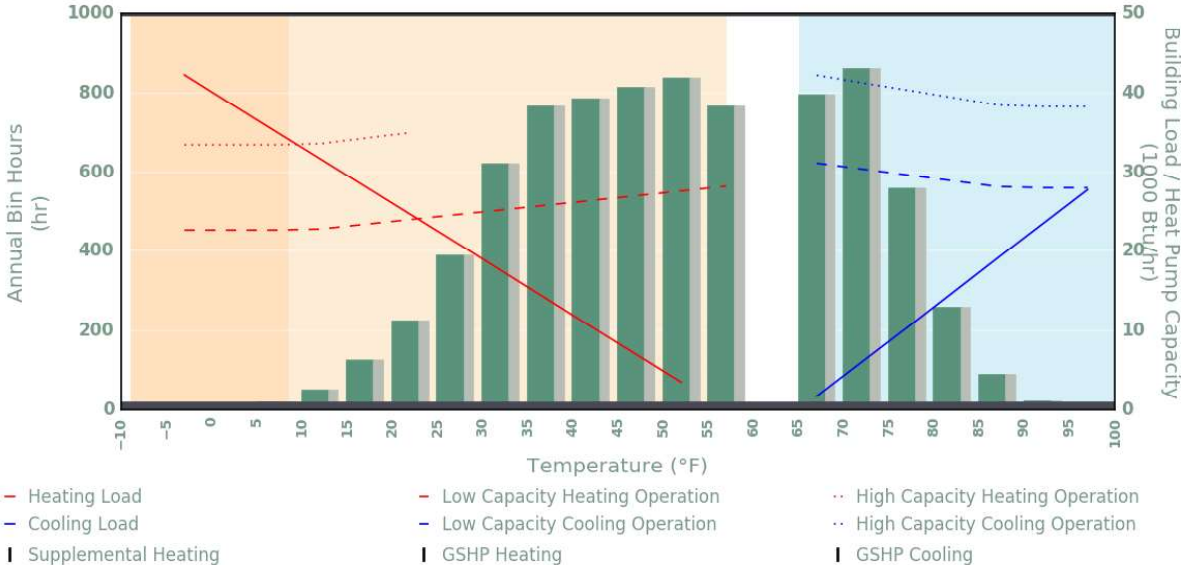
## Back-Up System Details

### Supplemental System Details

Supplemental systems operate at the same time as the geothermal heat pump and provide additional heat when the space load is greater than the system capacity.

Supplemental System Type **Electric Resistance** COP **1.0**

**Zone Load and Operating Profile**



### Heating

Heating Start OAT **57.0 °F**  
 High Capacity Runtime **340 hr**  
 Low Capacity Runtime **1,900 hr**  
 Supplemental Bin Hours **26 hr**

### Cooling

Cooling Start OAT **65.0 °F**  
 High Capacity Runtime **0 hr**  
 Low Capacity Runtime **767 hr**

168B

Zone Details

The peak loads for each individual zone are used to calculate the total amount of heating & cooling capacity required for a space based on the set points and the climate data for your area.

Peak Heating Load 30,187 Btu/hr	Peak Cooling Load 20,629 Btu/hr
Heating Set Point 70 °F	Cooling Set Point 75 °F
Heating Offset 0 Btu/hr	Space SHF 0.850

GSHP Selection

The ground source heat pump below has been selected to maintain comfortable heating & cooling for this zone.

Manufacturer Hydron Module  
 Model Split HRT036

Heat Pump Type Water to Air      Capacity Dual Capacity # Heat Pumps 1

Installed Capacity Check

The installed capacity check describes the efficiency and total heating/cooling capacity of the selected ground source heat pump system. This information is used to ensure proper sizing of equipment based on the load represented by this zone.

Heating

Heating Capacity 30,900 Btu/hr  
 % Sizing 102.4%  
 % Energy From Geo 99.9%  
 Installed COP 3.68  
 Balance Point Temp. 10.1 °F

Cooling

Total Cooling Capacity 35,600 Btu/hr  
 Sensible Cooling Capacity 26,700 Btu/hr  
 % Oversizing 52.3%  
 Installed EER 14.27

168B

### Zone Operating Summary

The Zone Operating Summary describes equipment runtime and the total annual power consumption for the GSHP operating in this zone.

#### Heating

HP Runtime 1,683 hrs  
 Supplemental Bin Hours 26 hrs  
 Dual Fuel Bin Hours 0 hrs  
  
 Heat Pump Energy Use 4,289 kWh  
 Pumping Energy Use 226 kWh  
 Supplemental Energy Use 22 kWh  
 Dual Fuel Energy Use 0 ccf

#### Cooling

HP Runtime 564 hrs  
  
 Heat Pump Energy Use 1,273 kWh  
 Pumping Energy Use 75 kWh

### GSHP Operating Cost Breakdown for Zone Name

Based on the annual power consumption of the system and the price per kilowatt hour in your area the estimated cost to maintain the set points for this zone are as follows:

#### Heating

HP Cost \$857.92  
 Supplemental Cost \$4.45  
 Dual Fuel Cost \$0.00  
 Pumping Cost \$45.28  


---

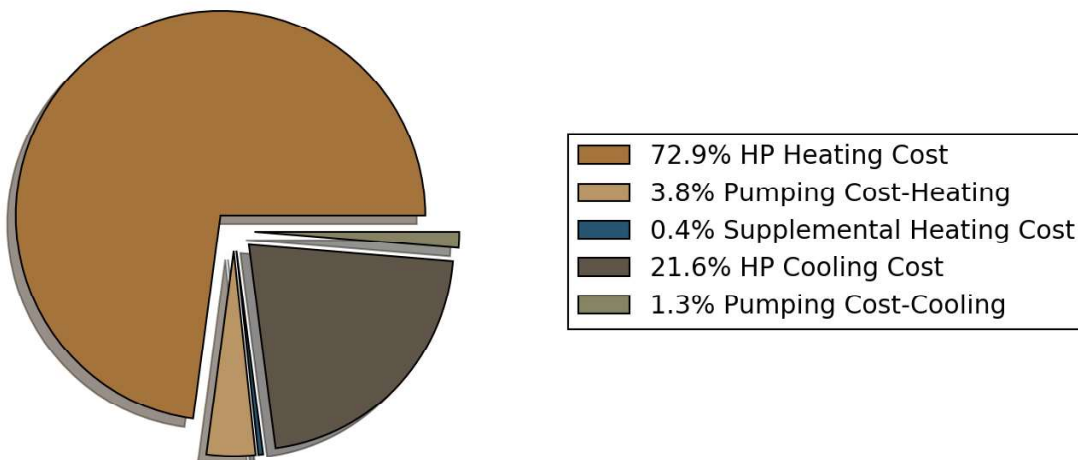
 Total Cost \$907.66

#### Cooling

HP Cost \$254.63  
 Pumping Cost \$15.17  


---

 Total Cost \$269.80



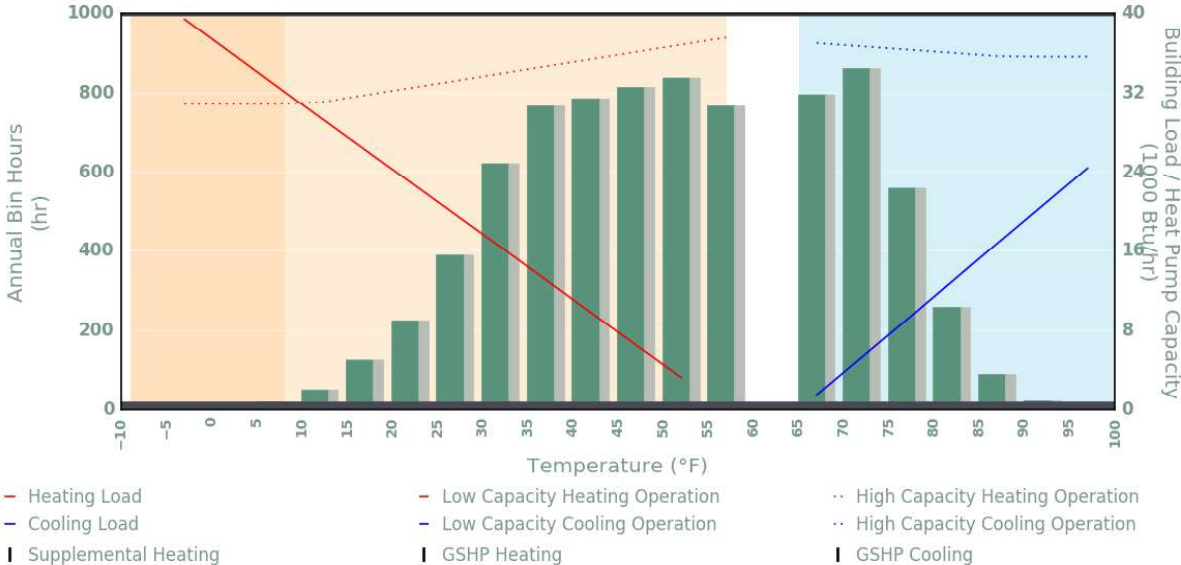
## Back-Up System Details

### Supplemental System Details

Supplemental systems operate at the same time as the geothermal heat pump and provide additional heat when the space load is greater than the system capacity.

Supplemental System Type **Electric Resistance** COP **1.0**

**Zone Load and Operating Profile**



### Heating

Heating Start OAT **57.0 °F**  
 High Capacity Runtime **1,683 hr**  
 Supplemental Bin Hours **26 hr**

### Cooling

Cooling Start OAT **65.0 °F**  
 High Capacity Runtime **564 hr**

168C

### Zone Details

The peak loads for each individual zone are used to calculate the total amount of heating & cooling capacity required for a space based on the set points and the climate data for your area.

Peak Heating Load 34,850 Btu/hr

Peak Cooling Load 22,973 Btu/hr

Heating Set Point 70 °F

Cooling Set Point 75 °F

Heating Offset 0 Btu/hr

Space SHF 0.850

### GSHP Selection

The ground source heat pump below has been selected to maintain comfortable heating & cooling for this zone.

Manufacturer Hydron Module

Model Split HRT036

Heat Pump Type Water to Air

Capacity Dual Capacity # Heat Pumps 1

### Installed Capacity Check

The installed capacity check describes the efficiency and total heating/cooling capacity of the selected ground source heat pump system. This information is used to ensure proper sizing of equipment based on the load represented by this zone.

#### Heating

Heating Capacity 30,900 Btu/hr

% Sizing 88.7%

% Energy From Geo 99.4%

Installed COP 3.68

Balance Point Temp. 15.4 °F

#### Cooling

Total Cooling Capacity 35,600 Btu/hr

Sensible Cooling Capacity 26,700 Btu/hr

% Oversizing 36.7%

Installed EER 14.27

168C

### Zone Operating Summary

The Zone Operating Summary describes equipment runtime and the total annual power consumption for the GSHP operating in this zone.

#### Heating

HP Runtime 1,921 hrs  
 Supplemental Bin Hours 75 hrs  
 Dual Fuel Bin Hours 0 hrs  
  
 Heat Pump Energy Use 4,896 kWh  
 Pumping Energy Use 258 kWh  
 Supplemental Energy Use 105 kWh  
 Dual Fuel Energy Use 0 ccf

#### Cooling

HP Runtime 625 hrs  
  
 Heat Pump Energy Use 1,412 kWh  
 Pumping Energy Use 84 kWh

### GSHP Operating Cost Breakdown for Zone Name

Based on the annual power consumption of the system and the price per kilowatt hour in your area the estimated cost to maintain the set points for this zone are as follows:

#### Heating

HP Cost \$979.22  
 Supplemental Cost \$21.17  
 Dual Fuel Cost \$0.00  
 Pumping Cost \$51.67  


---

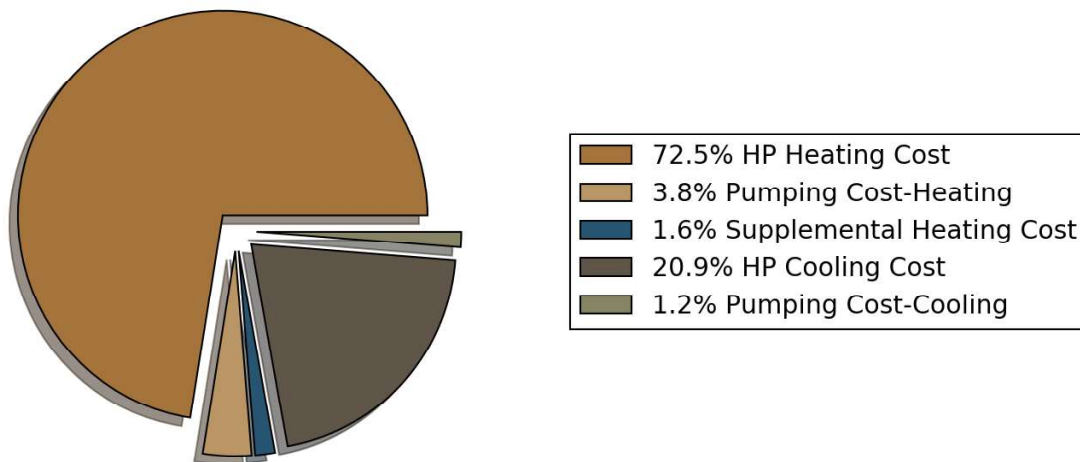
 Total Cost \$1,052.06

#### Cooling

HP Cost \$282.50  
 Pumping Cost \$16.83  


---

 Total Cost \$299.33



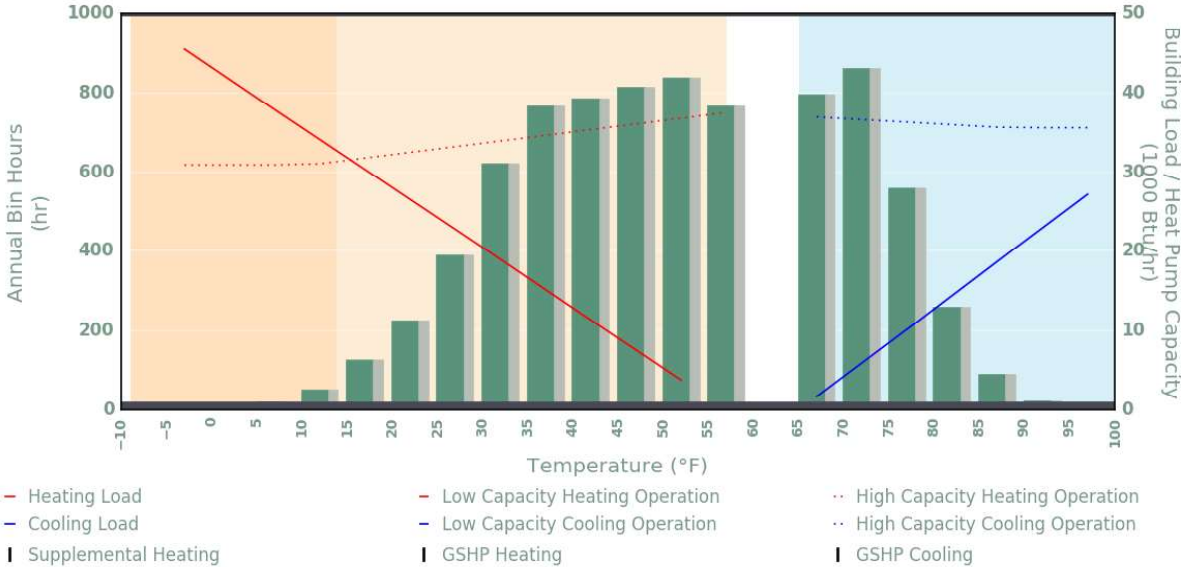
Back-Up System Details

Supplemental System Details

Supplemental systems operate at the same time as the geothermal heat pump and provide additional heat when the space load is greater than the system capacity.

Supplemental System Type Electric Resistance COP 1.0

Zone Load and Operating Profile



Heating

Heating Start OAT 57.0 °F  
 High Capacity Runtime 1,921 hr  
 Supplemental Bin Hours 75 hr

Cooling

Cooling Start OAT 65.0 °F  
 High Capacity Runtime 625 hr



Zone Details

The peak loads for each individual zone are used to calculate the total amount of heating & cooling capacity required for a space based on the set points and the climate data for your area.

Peak Heating Load 38,608 Btu/hr	Peak Cooling Load 23,936 Btu/hr
Heating Set Point 70 °F	Cooling Set Point 75 °F
Heating Offset 0 Btu/hr	Space SHF 0.850

GSHP Selection

The ground source heat pump below has been selected to maintain comfortable heating & cooling for this zone.

Manufacturer Hydron Module  
 Model Split HRT036

Heat Pump Type Water to Air                      Capacity Dual Capacity # Heat Pumps 1

Installed Capacity Check

The installed capacity check describes the efficiency and total heating/cooling capacity of the selected ground source heat pump system. This information is used to ensure proper sizing of equipment based on the load represented by this zone.

**Heating**

---

Heating Capacity 30,900 Btu/hr  
 % Sizing 80.0%  
 % Energy From Geo 98.7%  
 Installed COP 3.68  
 Balance Point Temp. 18.8 °F

**Cooling**

---

Total Cooling Capacity 35,600 Btu/hr  
 Sensible Cooling Capacity 26,700 Btu/hr  
 % Oversizing 31.2%  
 Installed EER 14.27

361

Zone Operating Summary

The Zone Operating Summary describes equipment runtime and the total annual power consumption for the GSHP operating in this zone.

Heating

HP Runtime 2,102 hrs  
 Supplemental Bin Hours 200 hrs  
 Dual Fuel Bin Hours 0 hrs  
  
 Heat Pump Energy Use 5,358 kWh  
 Pumping Energy Use 282 kWh  
 Supplemental Energy Use 256 kWh  
 Dual Fuel Energy Use 0 ccf

Cooling

HP Runtime 651 hrs  
  
 Heat Pump Energy Use 1,469 kWh  
 Pumping Energy Use 87 kWh

GSHP Operating Cost Breakdown for Zone Name

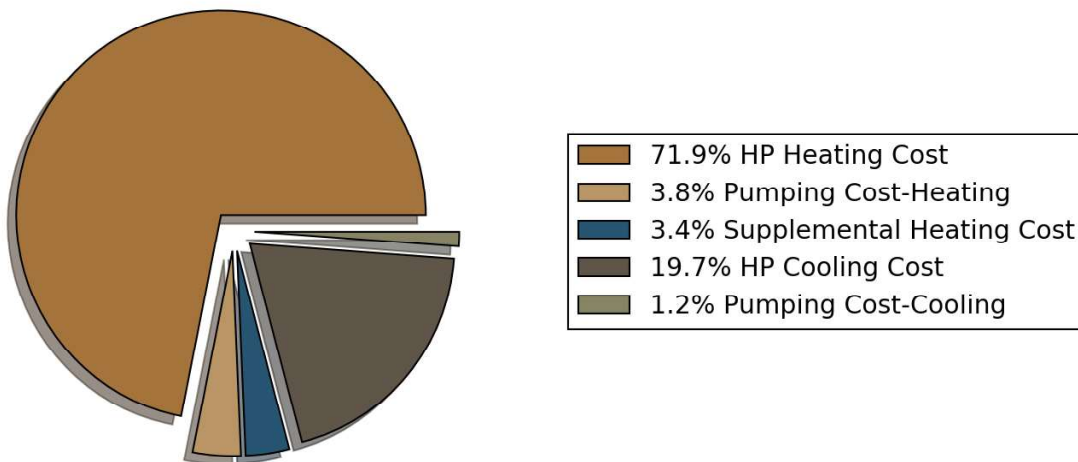
Based on the annual power consumption of the system and the price per kilowatt hour in your area the estimated cost to maintain the set points for this zone are as follows:

Heating

HP Cost \$1,071.72  
 Supplemental Cost \$51.40  
 Dual Fuel Cost \$0.00  
 Pumping Cost \$56.54  
  
 Total Cost \$1,179.66

Cooling

HP Cost \$293.89  
 Pumping Cost \$17.51  
  
 Total Cost \$311.40



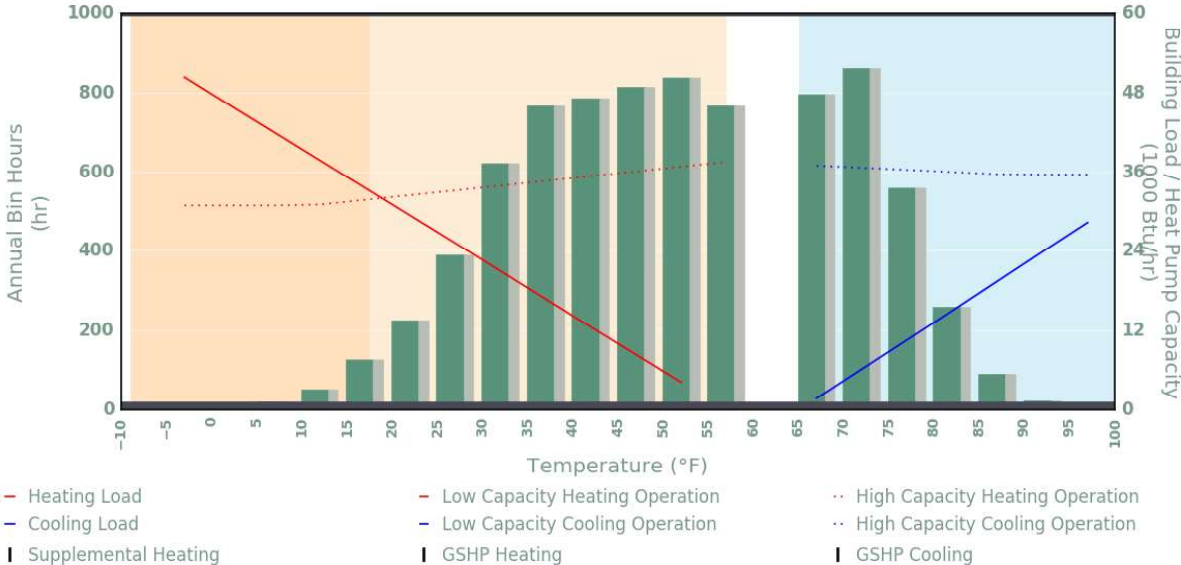
## Back-Up System Details

### Supplemental System Details

Supplemental systems operate at the same time as the geothermal heat pump and provide additional heat when the space load is greater than the system capacity.

Supplemental System Type **Electric Resistance** COP **1.0**

**Zone Load and Operating Profile**



### Heating

Heating Start OAT **57.0 °F**  
 High Capacity Runtime **2,102 hr**  
 Supplemental Bin Hours **200 hr**

### Cooling

Cooling Start OAT **65.0 °F**  
 High Capacity Runtime **651 hr**

Zone Details

The peak loads for each individual zone are used to calculate the total amount of heating & cooling capacity required for a space based on the set points and the climate data for your area.

Peak Heating Load 34,292 Btu/hr	Peak Cooling Load 22,663 Btu/hr
Heating Set Point 70 °F	Cooling Set Point 75 °F
Heating Offset 0 Btu/hr	Space SHF 0.850

GSHP Selection

The ground source heat pump below has been selected to maintain comfortable heating & cooling for this zone.

Manufacturer Hydron Module  
 Model Split HRT036

Heat Pump Type Water to Air      Capacity Dual Capacity # Heat Pumps 1

Installed Capacity Check

The installed capacity check describes the efficiency and total heating/cooling capacity of the selected ground source heat pump system. This information is used to ensure proper sizing of equipment based on the load represented by this zone.

Heating

Heating Capacity 30,900 Btu/hr  
 % Sizing 90.1%  
 % Energy From Geo 99.5%  
 Installed COP 3.68  
 Balance Point Temp. 14.8 °F

Cooling

Total Cooling Capacity 35,600 Btu/hr  
 Sensible Cooling Capacity 26,700 Btu/hr  
 % Oversizing 38.6%  
 Installed EER 14.27

Zone Operating Summary

The Zone Operating Summary describes equipment runtime and the total annual power consumption for the GSHP operating in this zone.

Heating

HP Runtime 1,893 hrs  
 Supplemental Bin Hours 75 hrs  
 Dual Fuel Bin Hours 0 hrs

Heat Pump Energy Use 4,824 kWh  
 Pumping Energy Use 254 kWh  
 Supplemental Energy Use 93 kWh  
 Dual Fuel Energy Use 0 ccf

Cooling

HP Runtime 617 hrs

Heat Pump Energy Use 1,394 kWh  
 Pumping Energy Use 83 kWh

GSHP Operating Cost Breakdown for Zone Name

Based on the annual power consumption of the system and the price per kilowatt hour in your area the estimated cost to maintain the set points for this zone are as follows:

Heating

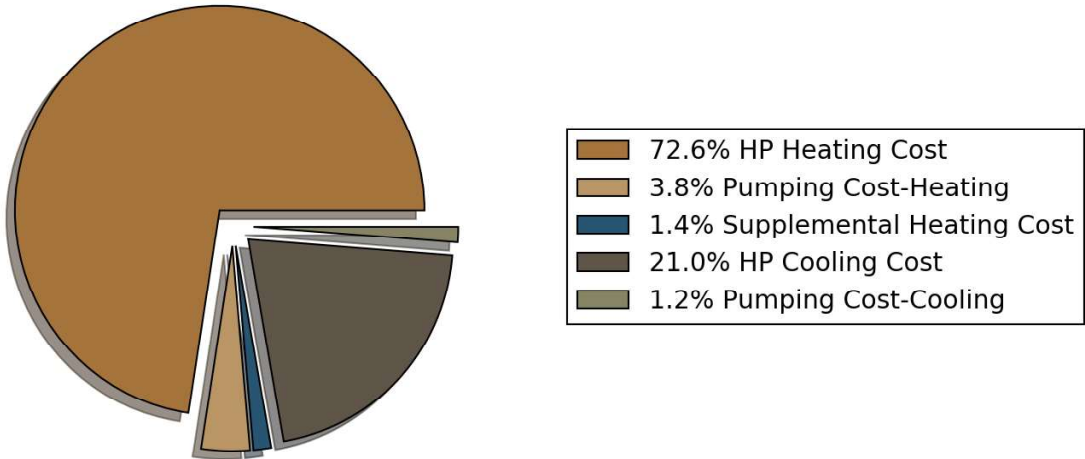
HP Cost \$964.92  
 Supplemental Cost \$18.65  
 Dual Fuel Cost \$0.00  
 Pumping Cost \$50.92

Total Cost \$1,034.49

Cooling

HP Cost \$278.83  
 Pumping Cost \$16.61

Total Cost \$295.44



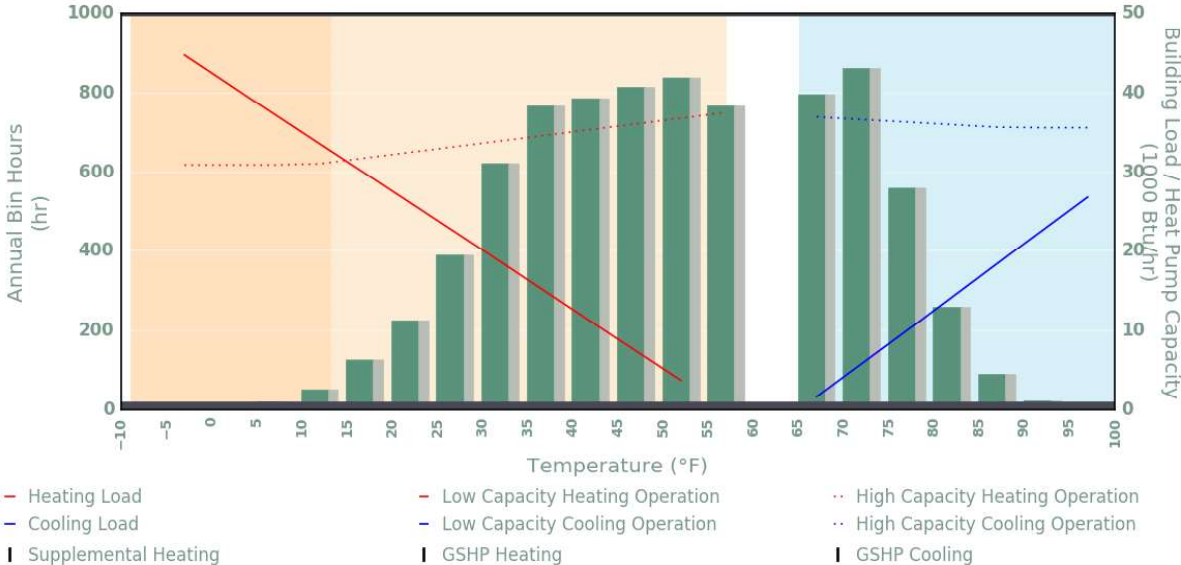
## Back-Up System Details

### Supplemental System Details

Supplemental systems operate at the same time as the geothermal heat pump and provide additional heat when the space load is greater than the system capacity.

Supplemental System Type **Electric Resistance** COP **1.0**

**Zone Load and Operating Profile**



### Heating

Heating Start OAT **57.0 °F**  
 High Capacity Runtime **1,893 hr**  
 Supplemental Bin Hours **75 hr**

### Cooling

Cooling Start OAT **65.0 °F**  
 High Capacity Runtime **617 hr**

Zone Details

The peak loads for each individual zone are used to calculate the total amount of heating & cooling capacity required for a space based on the set points and the climate data for your area.

Peak Heating Load 35,062 Btu/hr      Peak Cooling Load 23,134 Btu/hr  
Heating Set Point 70 °F      Cooling Set Point 75 °F  
Heating Offset 0 Btu/hr      Space SHF 0.850

GSHP Selection

The ground source heat pump below has been selected to maintain comfortable heating & cooling for this zone.

Manufacturer Hydron Module  
Model Split HRT036

Heat Pump Type Water to Air      Capacity Dual Capacity # Heat Pumps 1

Installed Capacity Check

The installed capacity check describes the efficiency and total heating/cooling capacity of the selected ground source heat pump system. This information is used to ensure proper sizing of equipment based on the load represented by this zone.

Heating

Heating Capacity 30,900 Btu/hr  
% Sizing 88.1%  
% Energy From Geo 99.4%  
Installed COP 3.68  
Balance Point Temp. 15.6 °F

Cooling

Total Cooling Capacity 35,600 Btu/hr  
Sensible Cooling Capacity 26,700 Btu/hr  
% Oversizing 35.8%  
Installed EER 14.27



363

Zone Operating Summary

The Zone Operating Summary describes equipment runtime and the total annual power consumption for the GSHP operating in this zone.

Heating

HP Runtime 1,932 hrs  
Supplemental Bin Hours 75 hrs  
Dual Fuel Bin Hours 0 hrs  
  
Heat Pump Energy Use 4,923 kWh  
Pumping Energy Use 259 kWh  
Supplemental Energy Use 110 kWh  
Dual Fuel Energy Use 0 ccf

Cooling

HP Runtime 630 hrs  
  
Heat Pump Energy Use 1,422 kWh  
Pumping Energy Use 84 kWh

GSHP Operating Cost Breakdown for Zone Name

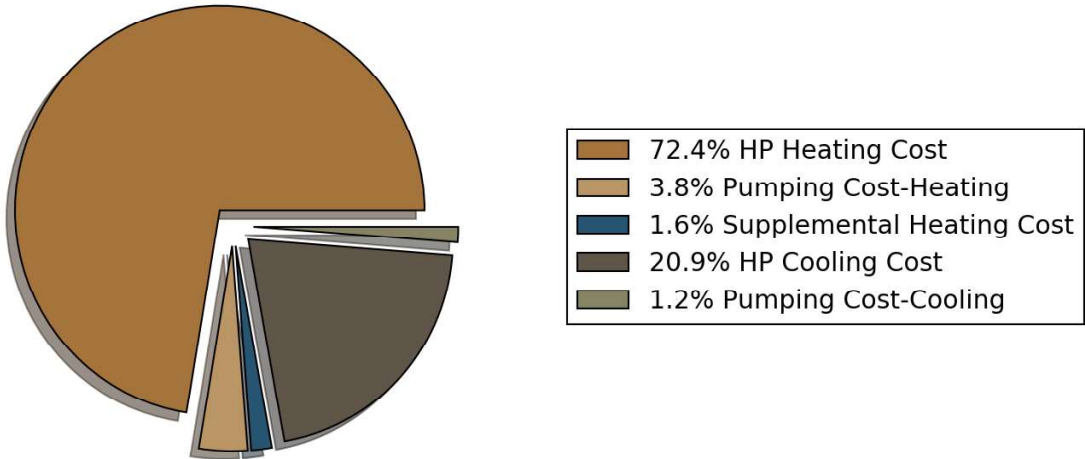
Based on the annual power consumption of the system and the price per kilowatt hour in your area the estimated cost to maintain the set points for this zone are as follows:

Heating

HP Cost \$984.64  
Supplemental Cost \$22.13  
Dual Fuel Cost \$0.00  
Pumping Cost \$51.96  
  
Total Cost \$1,058.73

Cooling

HP Cost \$284.41  
Pumping Cost \$16.94  
  
Total Cost \$301.35



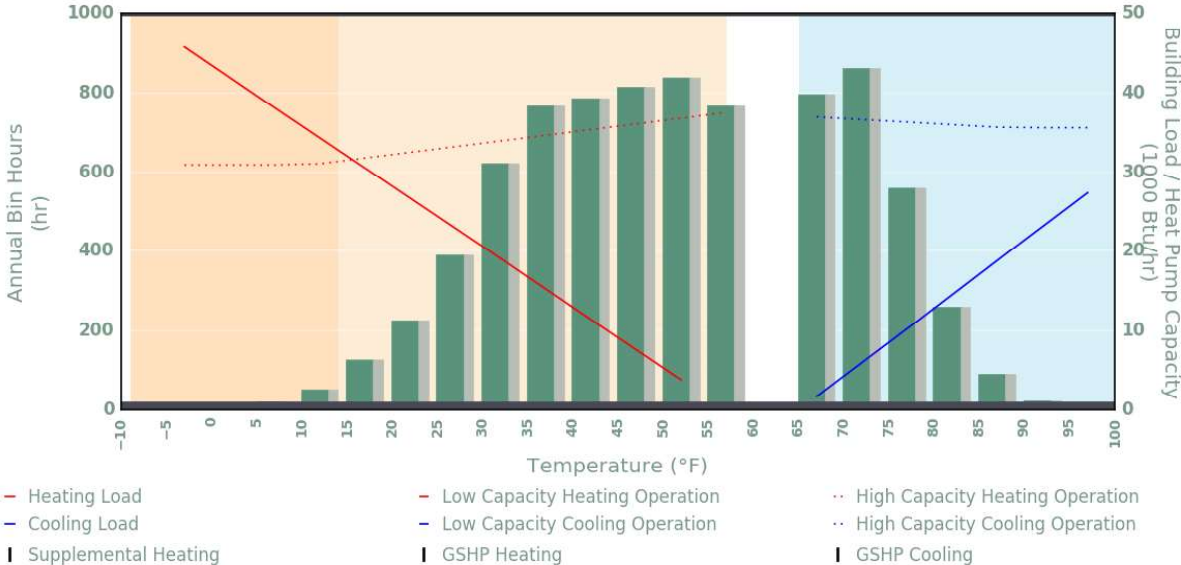
## Back-Up System Details

### Supplemental System Details

Supplemental systems operate at the same time as the geothermal heat pump and provide additional heat when the space load is greater than the system capacity.

Supplemental System Type **Electric Resistance** COP **1.0**

**Zone Load and Operating Profile**



### Heating

Heating Start OAT **57.0 °F**  
 High Capacity Runtime **1,932 hr**  
 Supplemental Bin Hours **75 hr**

### Cooling

Cooling Start OAT **65.0 °F**  
 High Capacity Runtime **630 hr**

Zone Details

The peak loads for each individual zone are used to calculate the total amount of heating & cooling capacity required for a space based on the set points and the climate data for your area.

Peak Heating Load 34,292 Btu/hr      Peak Cooling Load 22,663 Btu/hr  
Heating Set Point 70 °F      Cooling Set Point 75 °F  
Heating Offset 0 Btu/hr      Space SHF 0.850

GSHP Selection

The ground source heat pump below has been selected to maintain comfortable heating & cooling for this zone.

Manufacturer Hydron Module  
Model Split HRT036

Heat Pump Type Water to Air      Capacity Dual Capacity # Heat Pumps 1

Installed Capacity Check

The installed capacity check describes the efficiency and total heating/cooling capacity of the selected ground source heat pump system. This information is used to ensure proper sizing of equipment based on the load represented by this zone.

Heating

Heating Capacity 30,900 Btu/hr  
% Sizing 90.1%  
% Energy From Geo 99.5%  
Installed COP 3.68  
Balance Point Temp. 14.8 °F

Cooling

Total Cooling Capacity 35,600 Btu/hr  
Sensible Cooling Capacity 26,700 Btu/hr  
% Oversizing 38.6%  
Installed EER 14.27

Zone Operating Summary

The Zone Operating Summary describes equipment runtime and the total annual power consumption for the GSHP operating in this zone.

Heating

HP Runtime 1,893 hrs  
Supplemental Bin Hours 75 hrs  
Dual Fuel Bin Hours 0 hrs  
  
Heat Pump Energy Use 4,824 kWh  
Pumping Energy Use 254 kWh  
Supplemental Energy Use 93 kWh  
Dual Fuel Energy Use 0 ccf

Cooling

HP Runtime 617 hrs  
  
Heat Pump Energy Use 1,394 kWh  
Pumping Energy Use 83 kWh

GSHP Operating Cost Breakdown for Zone Name

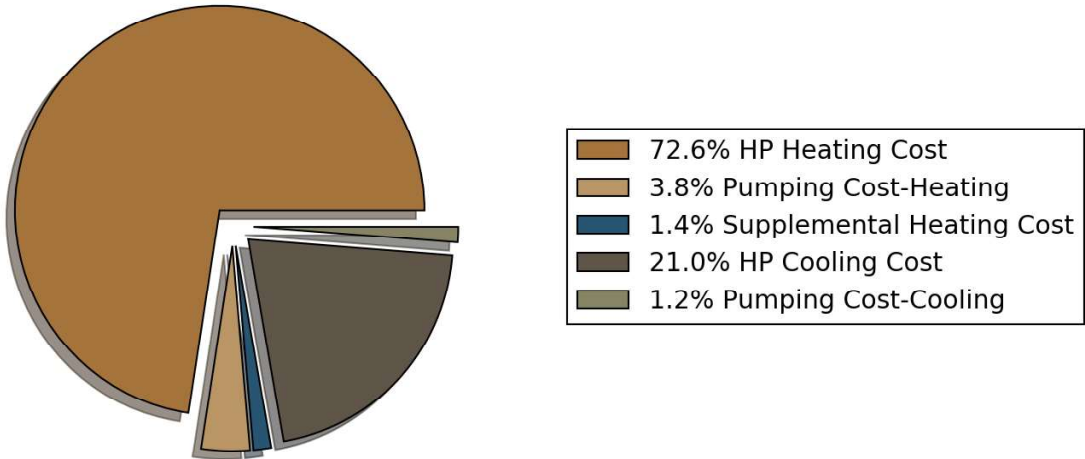
Based on the annual power consumption of the system and the price per kilowatt hour in your area the estimated cost to maintain the set points for this zone are as follows:

Heating

HP Cost \$964.92  
Supplemental Cost \$18.65  
Dual Fuel Cost \$0.00  
Pumping Cost \$50.92  
  
Total Cost \$1,034.49

Cooling

HP Cost \$278.83  
Pumping Cost \$16.61  
  
Total Cost \$295.44



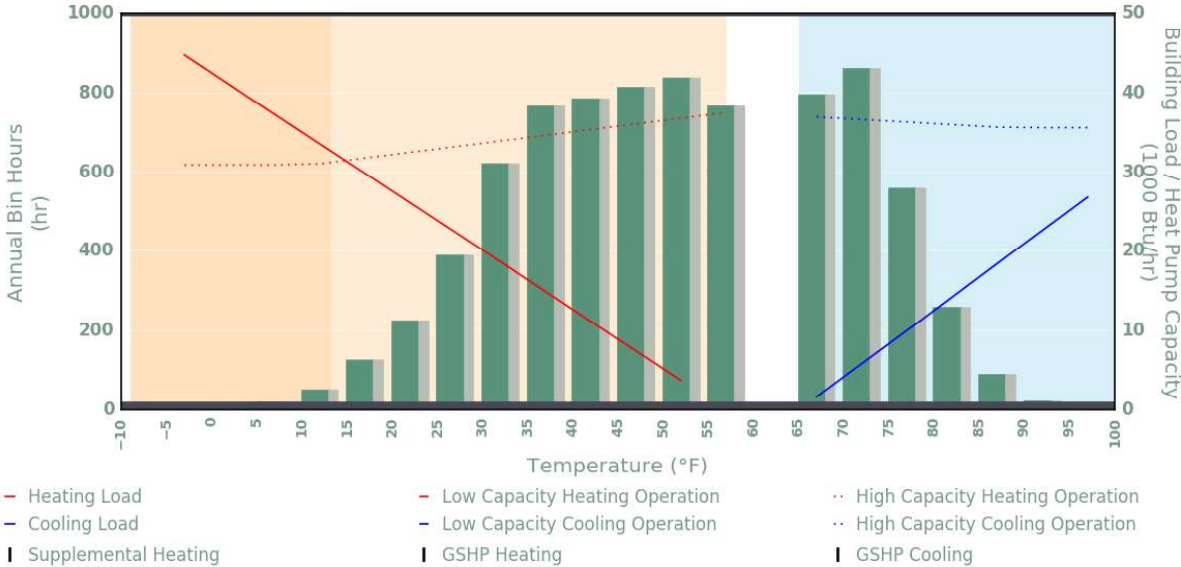
## Back-Up System Details

### Supplemental System Details

Supplemental systems operate at the same time as the geothermal heat pump and provide additional heat when the space load is greater than the system capacity.

Supplemental System Type **Electric Resistance** COP **1.0**

**Zone Load and Operating Profile**



### Heating

Heating Start OAT **57.0 °F**  
 High Capacity Runtime **1,893 hr**  
 Supplemental Bin Hours **75 hr**

### Cooling

Cooling Start OAT **65.0 °F**  
 High Capacity Runtime **617 hr**

Vertical Bore 1

Earth Temperature Data Location

Deep earth (below 20ft) temperature is a function of the average annual air temperature in your region and remains relatively constant regardless of season.

Deep Earth Temp ( $T_G$ ) 55.0 °F

Formation Details

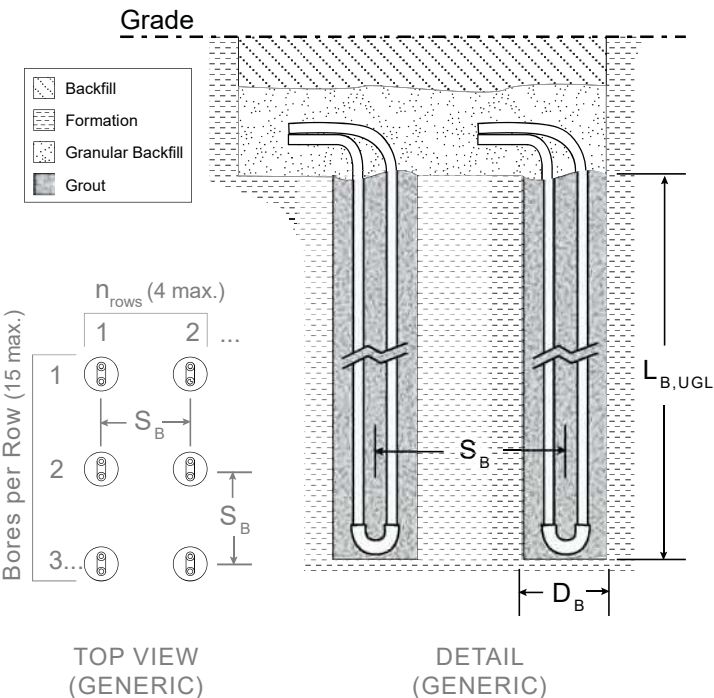
The thermal properties of your formation are based on the formation’s composition and have a direct impact on the scale of your loopfield.

Thermal Conductivity 1.60 Btu/hr ft °F

GHEX Summary

Heating is dominant.

Grout is used inside of all bores in order to protect the deep earth environment from surface contaminants and to provide a more effective contact surface with GHEX piping that optimizes heat transfer between the fluid pumped through your GSHP and the earth.



Grout T.C.	1.40 Btu/hr ft °F
$EWT_{MIN}$	37.0 °F
$EWT_{MAX}$	80.0 °F
Bore Diameter ( $D_B$ )	5.00 in
Pipe Diameter ( $D_p$ )	1.25 in
Pipe Material	HDPE 3608
Bores in Series ( $N_{BIS}$ )	1
Layout Rows ( $n_{ROWS}$ )	2
Bores per Row	10
Number of Bores	20
Bore Spacing ( $S_B$ )	20.0 ft
Bore Depth ( $L_B$ )	191 ft
Adj. Bore Depth* ( $L_{B,UGL}$ )	217 ft
System Run Fraction	0.565

\*Adj. Bore Depth is the adjusted bore depth. This is the depth of bore that should be used to accommodate unbalanced ground loads over time.

### Energy Prices

---

Standard Electric Rate	0.200 \$/kWh	Natural Gas Rate	2.750 \$/ccf
ASHP Electric Rate	0.200 \$/kWh	Propane Rate	3.750 \$/gal
GSHP Electric Rate	0.200 \$/kWh	Fuel Oil Rate	4.000 \$/gal

### Fixed Costs

---

The following describe fixed recurring annual costs.

GSHP Lease Payment	\$0.00/year	Propane Tank	\$0.00/year
Natural Gas Meter	\$0.00/year	Fuel Oil Tank	\$0.00/year

### Energy Price Inflation Rates

---

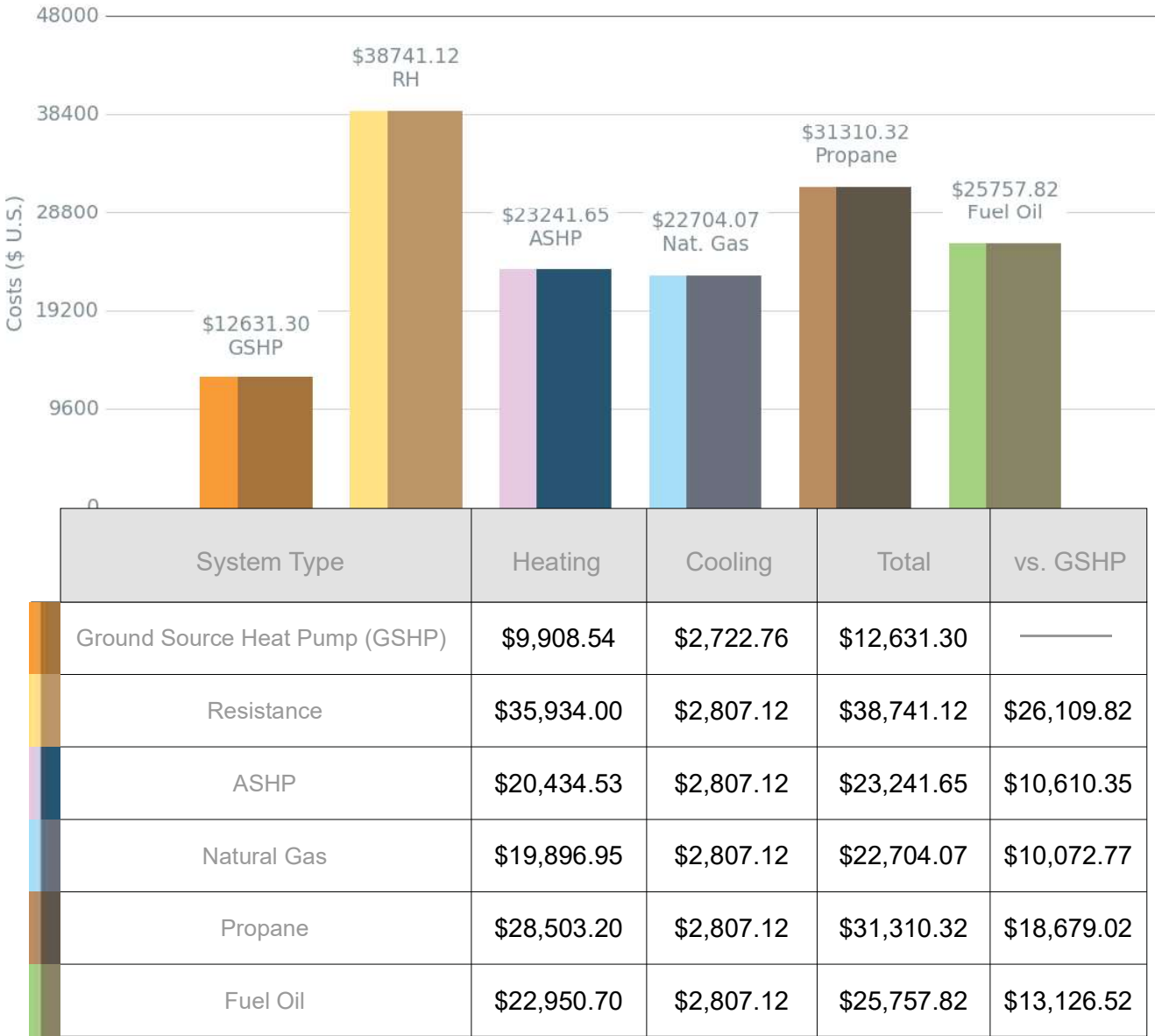
The following inflation rates are applied to long term economic analyses to give a more realistic evaluation of the long-term cost benefits of using GSHP.

Electricity	3.000%	Propane	3.000%
Natural Gas	3.000%	Fuel Oil	3.000%

## Economics: Operating Cost Summary

Actual costs and savings may vary from those reported. The methods of calculation and the data used are designed to approximate the total cost and savings of the GSHP system based on the weather conditions for an average year in your area. Additionally, the assumed rates of inflation and the unit prices for energy are subject to change according to the economy and your energy provider.

### Annual Operating Cost by Technology





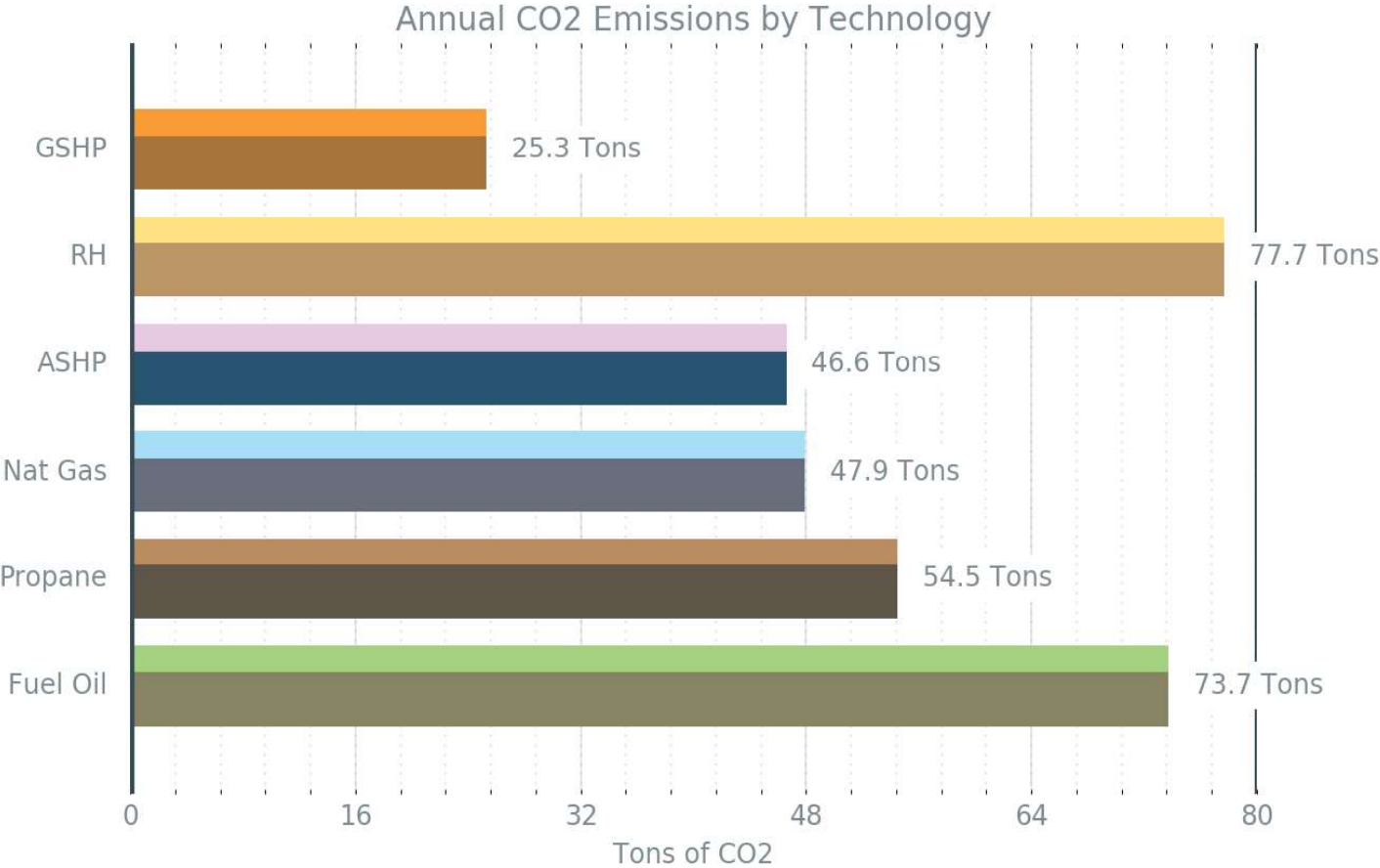
## Economics: Operating Cost Summary

### Annual CO2 Emissions by Technology

Geothermal heat pumps generate NO DIRECT EMISSIONS however, even “green” heating and cooling technologies like GSHPs produce “upstream” carbon emissions. The amount of these emissions depends on the power generation method in your area.

In areas where the primary power generation technology is nuclear, hydroelectric, wind turbine or solar, the upstream carbon emissions are minimal. However, the majority of the power in the United States is generated by coal fired power plants which emit a relatively higher volume of CO<sub>2</sub>.

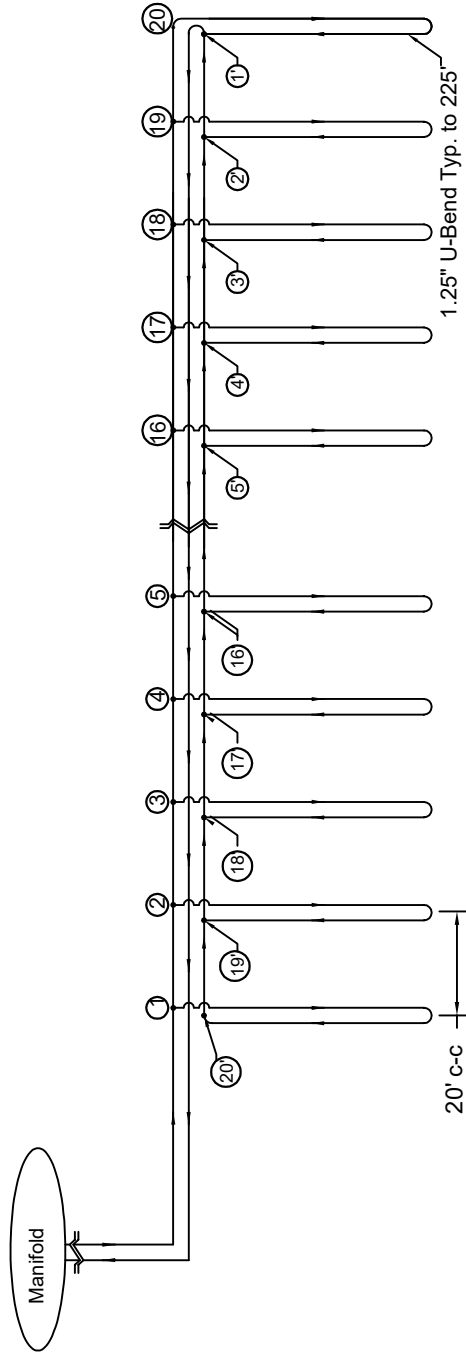
The emissions shown in the graph below are adjusted based on the mix of power generation methods in your region. Note that for natural gas, propane and fuel oil, only the point of use carbon emissions from the combustion of the fuel is considered not the upstream emissions resulting from their production.



Loopfield Specifications	
Grout TC	1.4
Grid	1 X 20
U-Bend Depth	225"
Spacing	20' c-c
U-Bend Dia.	1.25"
System Flow	90.0 gpm
S-R Flow	90.0 gpm
Flushing Flow	9.00 gpm/U-bend
Operating Flow	4.50 gpm/U-bend
EW Tmin	37 °F
EW Tmax	80 °F

Head Loss for 20 % Propylene Glycol by Volume at 35°F						
Pipe Run	Flow Rate (gpm)	Nom Size (in)	Pipe	Length (ft)	hl/100'	hl (ft)
Heat Pump	9.00	NA	NA	NA	NA	12.00
MECH-Manifold	9.00	1 1/2	HDPE DR-11	250	1.08	2.70
Manifold-1	90.00	3	HDPE DR-11	20	3.19	0.64
1-2	85.50	3	HDPE DR-11	20	2.92	0.58
2-3	81.00	3	HDPE DR-11	20	2.66	0.53
3-4	76.50	3	HDPE DR-11	20	2.40	0.48
4-5	72.00	3	HDPE DR-11	20	2.16	0.43
5-6	67.50	3	HDPE DR-11	20	1.93	0.39
6-7	63.00	3	HDPE DR-11	20	1.71	0.34
7-8	58.50	3	HDPE DR-11	20	1.50	0.30
8-9	54.00	3	HDPE DR-11	20	1.31	0.26
9-10	49.50	3	HDPE DR-11	20	1.12	0.22
10-11	45.00	3	HDPE DR-11	20	0.95	0.19
11-12	40.50	3	HDPE DR-11	20	0.79	0.16
12-13	36.00	3	HDPE DR-11	20	0.65	0.13
13-14	31.50	3	HDPE DR-11	20	0.51	0.10
14-15	27.00	3	HDPE DR-11	20	0.40	0.08
15-16	22.50	3	HDPE DR-11	20	0.29	0.06
16-17	18.00	2	HDPE DR-11	20	0.75	0.15
17-18	13.50	2	HDPE DR-11	20	1.08	0.22
18-19	9.00	1 1/2	HDPE DR-11	20	0.53	0.11
19-20	4.50	1 1/4	HDPE DR-11	450	0.53	2.39
20-1'	4.50	1 1/4	HDPE DR-11	20	3.19	0.64
1'-Manifold	90.00	3	HDPE DR-11	20	1.08	2.70
Manifold-MECH	9.00	1 1/2	HDPE DR-11	250	2.64	26.04
<b>Total</b>						<b>26.04</b>

Head Loss for 20 % Propylene Glycol by Volume at 35°F						
Pipe Run	Flow Rate (gpm)	Nom Size (in)	Pipe	Length (ft)	hl/100'	hl (ft)
Manifold-1	90.00	3	HDPE DR-11	20	3.19	0.64
1-2	85.50	3	HDPE DR-11	20	2.92	0.58
2-3	81.00	3	HDPE DR-11	20	2.66	0.53
3-4	76.50	3	HDPE DR-11	20	2.40	0.48
4-5	72.00	3	HDPE DR-11	20	2.16	0.43
5-6	67.50	3	HDPE DR-11	20	1.93	0.39
6-7	63.00	3	HDPE DR-11	20	1.71	0.34
7-8	58.50	3	HDPE DR-11	20	1.50	0.30
8-9	54.00	3	HDPE DR-11	20	1.31	0.26
9-10	49.50	3	HDPE DR-11	20	1.12	0.22
10-11	45.00	3	HDPE DR-11	20	0.95	0.19
11-12	40.50	3	HDPE DR-11	20	0.79	0.16
12-13	36.00	3	HDPE DR-11	20	0.65	0.13
13-14	31.50	3	HDPE DR-11	20	0.51	0.10
14-15	27.00	3	HDPE DR-11	20	0.40	0.08
15-16	22.50	3	HDPE DR-11	20	0.29	0.06
16-17	18.00	2	HDPE DR-11	20	1.23	0.25
17-18	13.50	2	HDPE DR-11	20	0.75	0.15
18-19	9.00	1 1/2	HDPE DR-11	20	1.08	0.22
19-20	4.50	1 1/4	HDPE DR-11	20	0.53	0.11
20-1'	4.50	1 1/4	HDPE DR-11	450	0.53	2.39
1'-Manifold	90.00	3	HDPE DR-11	20	3.19	0.64
<b>Total</b>						<b>8.64</b>



NOTES:  
 -20'-1" IS A MIRROR IMAGE OF 1-20  
 -DISTANCE FROM MANIFOLD TO "1" ASSUMED TO BE 20'  
 -DISTANCE FROM FARTHEST MECHANICAL TO MANIFOLD IS 250'



Title: **STARK HOMES (1 X 20)**  
 Paper Size: **8.5"x11"**  
 Drawn By: **RCARDA**  
 Date: **9-26-17**

## Appendix B

### Glenwood Village Site Inspection Report



Final Geothermal Inspection Report for:

**Glenwood Village  
Riverhead, NY**

*Prepared for:*  
**National Grid**

*Submitted 2018-04-30*

Brooklyn, NY

ATT: Mr. Chong Lin



the  
**GreyEdge**  
group

3962 Alpine Valley Circle  
Sandy, UT 84092  
801-244-8800

## Contents

Contents.....	2
1. Introduction.....	3
2. Definition of terms and acronyms.....	3
3. Project Overview.....	3
4. Inspection Methodology.....	4
5. Inspection Project Description & Results.....	6
5.1. Feasibility Documentation.....	6
5.2. Pre- Award Documentation.....	6
5.3. Post Award Submittal Review.....	6
5.4. Site Preparation.....	7
5.5. Drilling, Placement, Grouting.....	8
5.6. Hookup/ Headering.....	9
5.7. Final Fill.....	14
5.8. System Start-up/ Commissioning.....	14
5.9. Final Documentation.....	14
6. Conclusions/Findings/Recommendations.....	14
7. Attachments.....	17
7.1. Exhibit A. Thermal Conductivity Report Summary.....	17
7.2. Exhibit B. Formation Log.....	18
7.3. Exhibit C. Estimate of Thermal Diffusivity.....	19
7.4. Exhibit D. Contractor Qualifications.....	20
7.5. Exhibit E. Pre-Installation Submittal Data.....	22
7.6. Exhibit F. Flushing, Velocity Calculations and Inspection Form.....	25
7.7. Exhibit G. Flow Test Calculations and Inspection Form.....	27
7.8. Exhibit H. Pressure Test Inspection Forms.....	29
7.9. Exhibit I. As-built GPS locations, triangulations.....	32

## 1. Introduction

Ground source heat pump systems represent the most efficient heating and cooling technology choice in the world. To achieve these efficiencies, the earth is used as a heat source, sink, or both to meet a building's heating and cooling requirements. There are a number of different ways to tap into the "free" thermal assets of the earth for this purpose including "open" systems that draw water from the earth and "closed" systems that circulate a fixed volume of water through a heat exchanger buried in the earth or submerged in a body of water. Either type of system requires specialized design, installation, and inspection knowledge.

The Glenwood Village project will employ a vertical closed geothermal system connected to extended range water source heat pumps to provide 100% of the heating/cooling requirements for 10 homes in Riverhead, NY. Eight of the homes already exist on site and two are new "pre-fab" houses that are/will be delivered to the site. The geothermal system was installed by Miller Environmental Group from Riverhead, NY on a "design-build" basis. GeoConnections from Elkton, SD sized and designed the ground heat exchanger. The GregEdge Group was contracted to provide limited field inspection services during the final stage of the installation of the ground heat exchanger portion of the project.

Because the cost of a full time inspector exceeded the project budget, a program was devised to provide testing at the completion point of the GHX, along with a review of interim and progress testing completed prior to the on-site inspection. The intent was to give National Grid comfort that industry best-practices had been followed, and that an expectation of a properly performing project was appropriate. A further benefit of the on-site visit by the inspector would be to educate the owner (National Grid) and contractor on criteria for proper completion of unfinished work, and to discuss the quality control documentation that would be required for the balance of the project.

This report represents the observations of the inspector (John Turley) during his site visit 11/15/2017 and 11/16/2017, and his examination of available project documentation from contractors involved in the project. Observations were made in comparison to industry best practices, standards, and IMC 1208.1 Section 12.

## 2. Definition of terms and acronyms

- Circuit- a group of vertical heat exchangers joined together by supply and return piping that can be isolated from other circuits in the ground heat exchanger.
- CGI- IGSHPA Certified Geothermal Inspector
- CSA- Canadian Standards Association
- Closed loop: A continuous, sealed, underground, or submerged heat exchanger through which a heat-transfer fluid passes to and returns from a heat pump.
- District Loop- a closed outside heat exchanger configuration that provides the primary heat source/sink for multiple buildings.
- GSHP: Ground source heat pump, geothermal heat pump.
- GHX: Ground heat exchanger. Typically high-density polyethylene (HDPE) pipe buried in the ground in vertical boreholes (to depths up to 200 m or 650'), in horizontal boreholes (to depths up to 10 m or 33'), in horizontal trenches (to depths up to 2.5 m or 8'), or in surface water bodies such as ponds or lakes.
- GRTI: Geothermal Resource Technologies, Inc.
- IGSHPA- International Ground Source Heat Pump Association
- IMC- International Mechanical Code
- MEG- for this report MEG refers to Miller Environmental Group

## 3. Project Overview

A closed loop GHX will provide the primary heating and cooling source for Glenwood Village. The project includes 10 homes connected to a "district loop" comprised of 20 vertical heat exchangers drilled to a design depth of 225' below grade. The heat exchangers are factory constructed of 1-1/4" IPS DR-11 HDPE supply and return pipes joined with a 1-1/4" U-bend.



These heat exchangers are tied together with 3" supply and return mains piped in a reverse return configuration back to manifolds located centrally in the borefield area. 1 1/4" supply and return mains to the individual homes originate and return to this same area and can be isolated at both the manifold area, and at the houses with valves. Each home has a bypass assembly to allow maintenance and/or repairs to the systems in the individual homes without shutting down the entire system.

When all ten homes are connected to the system, they will each be heated and cooled by a 3-ton Hydron ground source heat pump. Eight of the ten homes have "split" systems, or systems with the compressor units located remotely (outside) from the air handler units due to limited mechanical space available inside the homes. Two of the homes have, or will have, 3 ton "packaged" heat pumps, also Hydron. At the time of this report, there was still one (pre-fab) home that had not been delivered to the site.

BTU meters installed outside each building will measure and record energy used by the individual homes for heating and cooling.



The vertical ground heat exchangers for the project, represented by the red dots (above), were installed in a wooded area central to the 10 homes.

#### 4. Inspection Methodology

The IGSHA Certified Geothermal Inspector training notes that for projects the size of the Glenwood Village, a comprehensive inspection program could include, but is not limited to the criteria listed in Table 1. Because, as mentioned in

the introduction, a comprehensive inspection program was not warranted or cost justified on this project, actual activities and tests that could be performed and documented on this project are highlighted in yellow.

**Table 1. Possible Geothermal Project Inspection Points**

Project Phase	Item or Procedure	Standards/Codes	Comments
1. Feasibility	TC Test		Provided by MEG
2. Pre-Award	Certification/Accreditations Required		Provided by MEG
	Licenses Needed		Provided by MEG
3. Post Award- Submittal Review	HDPE Pipe & Fittings		Pipe submittal provided by MEG, No Fitting Submittal provided
	Unicoils		Provided by MEG
	Grout Submittal		Provided by MEG
	Vaults & Manifolds		
	Valves		
	Marking System & Locators		
	Antifreeze & Inhibitors		Provided by MEG
	Final Fill Plan		
	Site Restoration Plan		
4. Site Preparation	Safety Review		
	Runoff protection		
	Equipment leaks		
	Other Issues		
5. Drilling, Pipe Placement, Grouting	Drilling activity report		Final Drilling depths provided by MEG
	Pipe verification		
	Pipe pressure testing		Pipe shipped with pressure charge
	Grout analysis & reports		Not performed
	Verification of borehole spacing		Conforms to design
6. Hookup/Headering	Horizontal piping inspection		See Field Report
	Flushing Inspection		See Field Report
	Flow Testing Inspection		See Field Report
	Pressure test inspection		See Field Report
	Vault Inspection		
	Building penetration inspection		
7. Final Fill	Interior pipe cleaning		
	System solution inspection		
8. startup, etc.			
9. Final Documentation	As-built drawing		Triangulation by MEG



## 5. Inspection Project Description & Results

GEG involvement in the Glenwood Village project began in the later stages of the hookup/headering (#6 in Table 1) phase of the project. Information from the first five phases mentioned above was requested and received prior to the site visit (see items highlighted in yellow above).

### 5.1. Feasibility Documentation

Prior to system design and construction Miller Environmental Group was hired to drill a test bore at the project site and perform a thermal conductivity test. Thermal conductivity tests are recommended by IGSHPA and CSA for commercial ground heat exchanger design. Three important reasons for conducting these tests are 1) to have a measured conductivity and deep earth temperature of the geology for accurate design, 2) to be able to estimate the thermal diffusivity of the formation, another design input, and 3) to acquire accurate information regarding the drilling conditions that can be used to solicit competitive bids. Even though the Glenwood project serves residential buildings, and conductivity tests are not typically done for residential projects, the fact that all ten buildings are tied together on a common district loop made this test advisable.

A test bore was drilled to a depth of 295', a 1 ¼" DR-11 HDPE U-bend assembly was inserted in the hole and the entire bore was grouted from bottom to top with a 1.4 TC graphite grout. According to David Reardon from Miller Environmental, "the extra boring depth was conducted to confirm upper glacial aquifer transition. The unused portion of the boring (from 225' to 295' below surface) was also grouted." The data collected from the 68.4 hr. test was sent to GRTI for analysis. The results can be found in **Exhibits A,B & C** in the Attachments to this report. The values for TC, deep earth temp and thermal diffusivity were used as inputs in the design of the ground heat exchanger for the project.

### 5.2. Pre- Award Documentation

Ground source heat pump systems typically require special licenses and certifications to comply with both local codes and quality control recommendations by industry groups like IGSHPA and CSA. The IGSHPA CGI (Certified Geothermal Inspector) training lists review of qualifications as an important step in the prequalification of installation contractors in the Pre-Award phase of a project.

Miller Environmental Group submitted copies of drilling, pipe fusion and installation licenses, certifications and accreditations before beginning the project. These can be found in **Exhibit D** in the Attachments to this report. These submittals satisfactorily met the standard requirements for the installation of a vertical closed loop ground heat exchanger in New York.

### 5.3. Post Award Submittal Review

Before traveling to the project site for the purpose and scope of inspection described above, GEG was provided submittal data for review. These included the engineer's design calculations, pipe data, grout data, antifreeze data. Please see **Exhibit E** at the end of this report for all submittal data for pipe, grout and antifreeze.

#### Design

As noted earlier, the ground heat exchanger was sized and specified by GeoConnections. Review of this design is outside the scope of this contract.

#### Pipe Data Review

The pipe submitted by MEG, and subsequently installed, is manufactured by Oil Creek Plastics. The resin (PE 4710), Dimension Ration (DR-11), and diameter (1-1/4" U-Bends, 3" mains, reducing headers) of the submission conforms to the project design. The pipe that was visually accessible on site was consistent with the submission.



The pipe observed on-site was consistent with the submittal data provided.

#### Grout Data

The design by Geoconnections specified and required a grout with a 1.4 conductivity to be placed in each borehole to provide a seal from bottom to top, and to provide the thermal characteristics necessary to ensure the heat transfer necessary for the project to meet design expectations. MEG submitted on a grout/sand mix to be used to meet these criteria. **This submittal can be found in Exhibit E.**

An IGSHPA inspection criterion recommends that third party verification of the grout conductivity be a part of the quality control process. At the point the inspection contract was issued the grouting phase of the project had already been completed so this was not possible. Based on the certifications and licenses mentioned above, the assumption is that this work was performed properly.

#### Antifreeze

MEG used a final system solution comprised of City water and Dowfrost inhibited propylene glycol. According to the product data sheets, this will provide freeze protection to 19 degrees F.

**Please see Exhibit E** for the antifreeze submittal. The final system fill and introduction of the antifreeze was performed after John Turley's site visit and was overseen by National Grid. Throughout an unusually cold winter, with water temperatures returning the borefield as cold as the high 20's (degrees F), there were no freezing issues experienced and reportedly no nuisance shutdowns of heat pumps as a result of low entering water temperatures or low flow caused by freezing.

### 5.4 Site Preparation

The site preparation phase of the project was overseen by representatives from National Grid.



## 5.5 Drilling, Pipe Placement, Grouting

This phase of the installation process was also overseen by representatives from National Grid. Important considerations during this phase include, but are not limited to:

1. Verification that the correct (design) drilling depth is reached to allow insertion of the vertical piping.
2. Verification that the factory manufactured uncoil assemblies are pressure tested prior to insertion in the boreholes.
3. Verification that the uncoil assemblies reach designed depth without using any mechanical assistance that could compromise the integrity of the heat exchangers.
4. Verification that the correct grout and other materials are being used to seal the boreholes.
5. Verification that the heat exchangers are grouted from bottom to top and that any settling that occurs is remedied by adding more grout until the subsiding stops.

Post installation some of these items can be verified if the tops (tag ends) of the heat exchanger assemblies are left open in the excavation. In this case, only the horizontal mains and runout piping were visible during the GEG inspection phase. According to MEG, this was done in order to keep progress going to meet the project schedule.



During the GEG inspection period only the horizontal piping could be observed. The tops of the vertical heat exchangers were buried in order to make room for piping.

MEG drilling personnel kept records of depth reached for each of the 20 boreholes. The total length of borehole exceeded the engineer's design by 200'. Theoretically, if MEG was able to insert the uncoils to the drilled depth on every hole this

translates to 200' more total heat exchange capacity than specified by design. GEG has not received any further verification of this.

<u>Hole #</u>	<u>Total Depth</u>
1	225
2	241
3	240
4	192
5	240
6	195
7	220
8	226
9	242
10	244
11	245
12	245
13	245
14	245
15	230
16	245
17	245
18	245
19	245
20	245
<b>Total</b>	<b>4700 bore feet</b>

All depths are measured from grade per Dave Reardon.

## 5.6 Hookup/Headering

### Horizontal Piping Inspection

Inspection of the horizontal piping is important for a number of reasons including, but not limited to:

1. Verification that design materials were used.
2. Verification that subsidence of grout at the top of the boreholes has stopped.
3. Verification that the piping is properly bedded in a material that will not allow wearing over time due to pipe movement from expansion and contraction.
4. Verification that the pipe sizing (diameter) conforms to design requirements and the piping pattern is correct.

On this project, all of the above items, with the exception of number 2 could be visually verified. Grout subsidence could not be checked as the tops of all twenty boreholes were already covered with backfill materials.

Piping from the houses to the main valves connecting the houses to the borefield was also buried before the GEG inspection period and could only be verified where the pipes entered the houses.





On November 15<sup>th</sup> and 16<sup>th</sup>, 2017, the exposed piping at the project was inspected with particular interest in verification of the four criteria mentioned above. All three of four could be verified and passed the inspection. MEG was also observed by the inspector performing both socket fusion and electrofusion. The work was done in a manner consistent with IGSHPA training and standards.



Pipe markings verified that the specified materials had been installed. Pipe configuration and pattern was consistent with the design.





All exposed piping observed on November 15, 16 had been bedded in sand which was free from rocks, stones and sharp objects.

### Flushing Inspection

The borefield portion of the ground heat exchanger was flushed on November 15<sup>th</sup> at the IGSHPA/CSA 448 minimal flushing velocity of 2 ft/sec. Flushing was performed by MEG and witnessed by John Turley. An ultrasonic flow meter was used to measure flow within the mains to the two circuits. The flow needed to meet the IGSHPA standard was calculated as  $9.03 \times 20$  heat exchangers = 180.60 gpm. A flow rate of 185 gpm was used as the target flow rate. The target elapsed time was 1 hour. Please see **Exhibit F** for the flushing calculation and inspection form.



Actual flow rates achieved during the flushing period ranged between 197 gpm and 200 gpm. Direction of flow was reversed after the first 35 minutes. The total flushing period was 80 minutes.

Flushing was only observed by John Turley for the portion of the outside heat exchanger from the valve manifolds to the circuits of boreholes. Flushing of the piping from the valve manifolds to the houses was not performed during the inspector's site visit and was observed by National Grid at a later.

### Flow Test Inspection

The purpose of the IMC flow test is to prove mathematically that there are no obstructions, kinks resulting in blocked flow, or cross connected pipes in the ground heat exchanger. This is accomplished by recording the pressure drop across the entire borefield while circulating water at the design system flow rate. This pressure drop is compared to a pre-calculated pressure drop and held to a + or – 10% variance for a “pass.” Generally, this test is performed on the entire GHX including the runs to the building but, given the phased nature of this project and importance of getting houses “on-line” before cold weather, the decision was made to do the flow test only on the GHX portion of the system. This portion is the most critical from the standpoint of identifying any of the potential issues mentioned above.

The IMC flow test was performed at Glenwood Village on 11/15/2017 by MEG and observed by John Turley. The test flow rate was 90 gpm with an expected (precalculated) pressure drop of 8.73 psi and an allowable range of 7.86 to 9.60 psi. Actual pressure drop observed was 8.0 psi which was in the passing range. See **Exhibit G** for the flow test calculation and inspection form.

## IMC Flow Test



Flow: 90.221 gpm



Gauge 1: 14 psi



Gauge 2: 6 psi

### Pressure Test Inspections

IGSHPA and CSA recommend that pressure testing of the outside heat exchanger be performed at a minimum of 100 psi for an hour. The allowable variance for passing this test is + or – 5%. The test can be performed with water or air, with water being the preferred method.

Pressure testing of the field and laterals to the houses was done in two phases. During this inspector's trip to the project, the intent was to perform the pressure test for the borefield and manifold portion of the project. Due to problems with leaks on the MEG testing equipment, and heavy rains at the project site, this test could not be accomplished until the next day. The test was performed on 11/17/2018 and witnessed internally (MEG) by Dave Reardon. Dave Reardon has since completed his IGSHPA CGI training and would be considered a competent inspector with the caveat of his employment at MEG. The pressures remained in the passing range for the duration of the test.

On 11/29/2017 two pressure tests were performed. First a test was performed on the portion of the piping from the manifold area to the houses. A second test was then performed on the laterals and the borefield, which is essentially the entire system excluding the piping inside the homes. Both tests were witnessed by Mr. Chong Lin from National Grid. The pressures remained in the passing range for the duration of both tests.

Record of the pressure testing can be found in **Exhibit H**.



## 5.7 Final Fill

After completion of final flushing, pressure testing and flow testing, MEG added PG antifreeze to the base fluid which was city water to protect the loop from any possibility of freezing during heating months. MEG calculated the total system volume to be 1350 gallons, which was comprised of about 850 gallons in the field and 500 gallons in the laterals to the homes.

275 gallons of Dowfrost inhibited Propylene Glycol was added to the system by displacing existing water. According to the Dowfrost submittal provided by MEG, this should result in a system fluid freezing level of about 19 deg F.

This work was completed by MEG. There were no representatives from National Grid present during glycol insertion. Based on data provided by National Grid, and using one unit (#8) for a check, water temperatures back to the field did not go lower than the high 20's this past winter, approximately 10 degrees F above the freeze protection point of the system solution. See the Conclusions section of this paper for a chart.

## 5.8 System Startup/Commissioning

System startup and commissioning were performed outside the scope of this inspection contract.

## 5.9 Final Documentation

An inspection program should include verification that records were kept that will memorialize important information like location of portions of the system that are buried, data on the system including antifreeze type and quantity, equipment and control information, and any other information that would help troubleshoot problems in the future. This information is also important for finding parts and replacement equipment in the event of a failure of a component. The information should be kept permanently by both the owner and the installing contractor.

To date this inspector has not been provided with any final documentation of the system with the exception of the triangulation points for the location of the valve manifolds measured from a nearby equipment shed and GPS locations of the twenty vertical heat exchangers. It is recommended that National Grid obtain this information, if it has not already been provided. See **Exhibit I for the hole and manifold location information**.

# 6. Conclusions/Findings/Recommendations

The GreyEdge Group's inspection of the Glenwood Village project was conducted by John Turley on November 15 and 16, 2017, and augmented by preliminary information supplied by Miller Environmental Group and National Grid. Information was also submitted after the inspection through April 18, 2018 for review by the inspector. There were not items identified during the inspection process that were outside the generally accepted standards of IGSHPA and CSA448-16. The caveat to this statement is that the inspection only included a small segment of time, and many of the desired inspection points that should be visually checked were either backfilled and not visible, or not yet performed when the inspector was on site. The inspector relied on information supplied by MEG and/or National Grid for subsequent evaluation.

Items that were reviewed for context only with **no opinion** rendered due to them being outside the scope of the contract included:

1. Project design documentation from GeoConnections.
2. Project thermal conductivity test results.

3. Formation bore log.
4. Estimate of thermal diffusivity
5. Temperature data from first few months of operation.

Items that were inspected during the on-site visit included the following:

1. Verification of materials used, conformance of piping arrangement to submitted design.
2. Verification of piping arrangement vs. submitted design.
3. Verification of proper backfilling, bedding, and protection of horizontal piping.
4. Observance of fusion technique- socket fusion and electrofusion.
5. Verification of borefield flushing.
6. Observance of termination points for piping at the homes.

**No issues were noted.**

Items that were reviewed prior to and after on-site inspection included:

1. Contractor Certifications, Licenses and Accreditations
2. Pipe submittal
3. Grout submittal
4. Pressure Test Reports
5. Drilling depths report
6. Hole location GPS points.
7. Manifold location triangulation points.

**No issues were noted.**

Items that were not inspected included:

1. Pressure testing- due to contractor problems with testing equipment and heavy rains on site.
2. Flushing and testing of the "house" side of the GHX.
3. Final system fill and antifreeze insertion
4. System start- up and commissioning.

Overall, the quality of work observed being performed on-site was very good and both Miller Environmental Group and National Grid should be complimented for the care and attention to detail that was put into coordinating a project that impacted ten different home owners, eight of whom were living in their homes during the construction of the project.

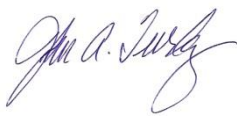
Some basic suggestions for future projects from this inspector's perspective would include:

1. Consider a more extensive inspection program that starts before the bid phase, if the project is large enough to absorb the cost.
2. Incorporate a list of submittal items required into the scope of future bid documents.
3. Incorporate a list of closeout items required at the end of the project into the bid documents.
4. Incorporate specific desired testing procedures into the bid documents including the forms for observation of the tests.
5. Specify testing methodologies that are preferred such as hydrostatic pressure testing.
6. Develop a project inspection schedule with milestones for testing and determine before the project starts who may observe work and sign off on it.

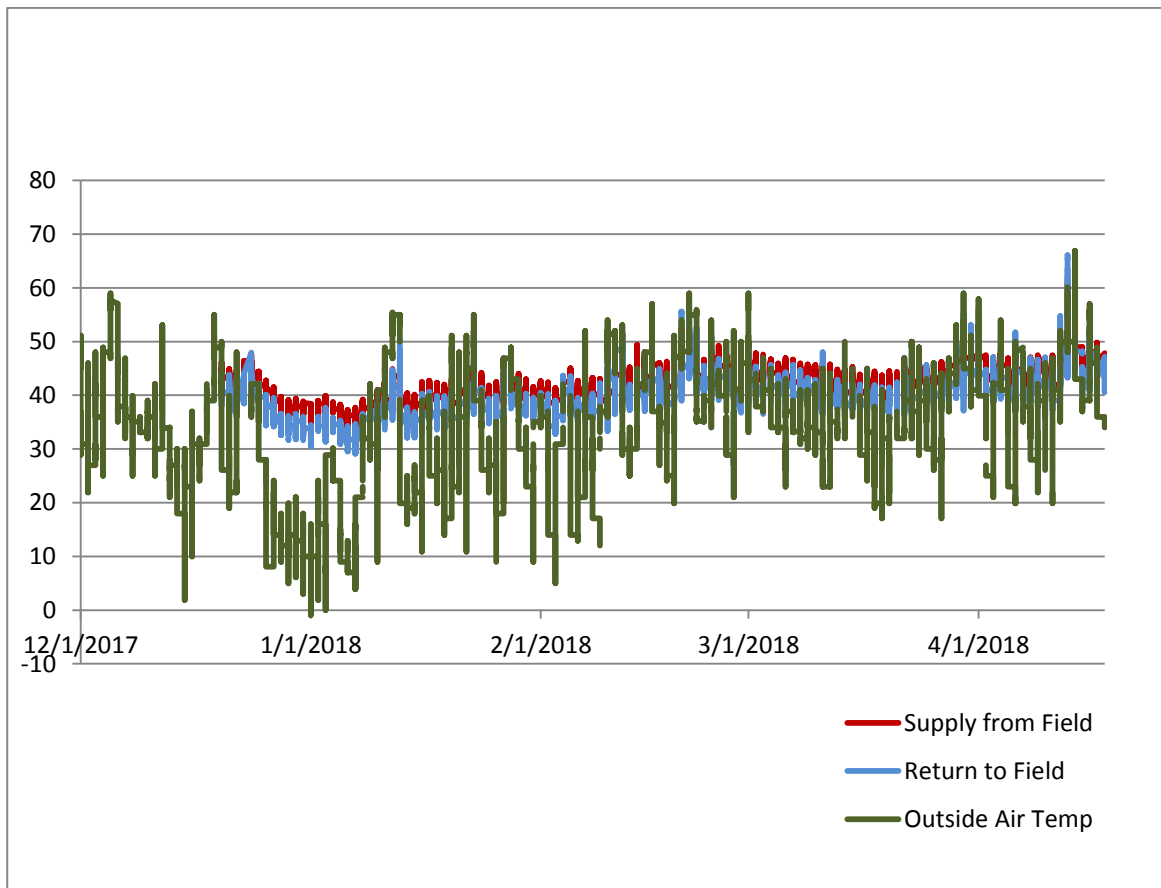
7. Specify the capabilities of the testing equipment desired to accompany item 4 above. For example, hydrostatic test unit and digital pressure gauges.

As a final note, National Grid shared operating data from the startup of the project through April 18, 2018 with the inspector. Even through an unusually cold winter, and without the benefit of a cooling season heating the earth before the winter, entering water temperatures remained in a range above the freeze point of the system solution and heating COP's were much higher than any fossil fuel heating source could have provided. The information seen by this inspector showed little if any use of resistance backup heat during this period. A graph of the temperatures from one of the heat pumps follows this report. The performance of the ground heat exchanger to date seems to indicate that the system will work well in the future if properly operated and maintained.

Respectfully submitted,



THE GREYEDGE GROUP  
John A. Turley, CGD, CGI



Performance data from Unit #8 from start-up through April 18, 2018

## 7. Attachments

### 7.1. Exhibit A. Thermal Conductivity Report Summary

GEOTHERMAL RESOURCE TECHNOLOGIES INC.

WWW.GRTI.COM

#### **EXECUTIVE SUMMARY**

A formation thermal conductivity test was performed on the geothermal bore with a GPS location of N 40° 55' 12.86" (latitude), W 72° 41' 48.36" (longitude) at the Glenwood Village site in Riverhead, New York. The vertical bore was completed on July 28, 2017 by Miller Environmental Group, Inc. Geothermal Resource Technologies' (GRTI) test unit was attached to the vertical bore on the afternoon of August 1, 2017.

This report provides an overview of the test procedures and analysis process, along with plots of the loop temperature and input heat rate data. Due to variation in the supplied power a limited amount of data was used for analysis. Results from a smaller data set can be more sensitive to fluctuations in ambient temperature and supplied power, and an additional test is recommended. The collected data was analyzed using the "line source" method and the following average formation thermal conductivity was determined.

**Formation Thermal Conductivity = 1.63 Btu/hr-ft-°F**

Due to the necessity of a thermal diffusivity value in the design calculation process, an estimate of the average thermal diffusivity was made for the encountered formation.

**Formation Thermal Diffusivity ≈ 1.21 ft<sup>2</sup>/day**

The undisturbed formation temperature for the tested bore was established from the initial loop temperature data collected at startup.

**Undisturbed Formation Temperature ≈ 54.1-55.9°F**

The formation thermal properties determined by this test do not directly translate into a loop length requirement (i.e. feet of bore per ton). These parameters, along with many others, are inputs to commercially available loop-field design software to determine the required loop length. Additional questions concerning the use of these results are discussed in the frequently asked question (FAQ) section at [www.grti.com](http://www.grti.com).

AUGUST 10, 2017

1 OF 7

FTC TEST REPORT

7.2. Exhibit B. Formation Log

**TEST BORE DETAILS**

(AS PROVIDED BY MILLER ENVIRONMENTAL GROUP, INC.)

Site Name ..... Glenwood Village  
 Location..... Riverhead, NY  
 Driller ..... Miller Environmental Group, Inc.  
 Installed Date ..... July 28, 2017  
 Borehole Diameter..... 5 inches  
 U-Bend Size ..... 1 ¼ inch HDPE  
 U-Bend Depth Below Grade ..... 225 ft  
 Grout Type ..... GeoPro PowerTECx 1.4  
 Grout Mixture..... 150 lb TG Lite to 64 lb PowerTEC  
 Grouted Portion ..... Entire bore

**DRILL LOG**

FORMATION DESCRIPTION	DEPTH (FT)
Topsoil	0'-1'
Dark organic topsoil sand mix	1'-5'
Brown fine-medium grained sand, small 1/8-1/4" gravel mix, trace organic matter	5'-50'
Brown fine-medium grained sand	50'-100'
Brown fine-medium grained sand	100'-120'
Gray clay	120'-135'
Silty mixed clay, fine-medium grained sand	135'-200'
Mixed gravel, clay, sand	200'-280'
Medium-fine sand	280'-295'

### 7.3. Exhibit C. Estimate of Thermal Diffusivity

#### **THERMAL DIFFUSIVITY**

---

The reported drilling log for this test borehole indicated that the formation consisted of clay, sand and gravel. A weighted average of heat capacity values based on the indicated formation was used to determine an average heat capacity of 32.2 Btu/ft<sup>3</sup>-°F for the formation. A diffusivity value was then found using the calculated formation thermal conductivity and the estimated heat capacity. The thermal diffusivity for this formation was estimated to be 1.21 ft<sup>2</sup>/day.



7.4. Exhibit D. Contractor Qualifications

NEW YORK STATE DEPARTMENT OF ENVIRONMENTAL CONSERVATION

Division of Water, Water Well Program  
625 Broadway, Albany, New York 12233-3508  
Toll Free: (877) 472-2619 | P: (518) 402-9066 | F: (518) 402-9290  
www.dec.ny.gov

01556

Dear Water Well Contractor:

MAR 29 2017

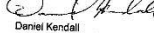
Please find enclosed your 2017 Water Well Contractors' registration certificate for the New York State (NYS) Water Well Program. Vehicle registration stickers have been provided, with one sticker for each registered vehicle, based on the information provided on your registration form. Please refer to the diagram on the reverse side of this letter for proper sticker placement.

As a reminder, the NYS Water Well Driller Registration Law, §15-1525 of NYS Environmental Conservation Law (ECL), requires the following:

- For drilling activities, an individual must be onsite who has passed two exams (General Drilling Exam and one additional drilling exam) to satisfy certification requirements. For pump installation and servicing activities within a well, an individual must be onsite who has passed two exams (Water Systems General Exam and one additional pump exam) to satisfy certification requirements. Individuals who engage in drilling AND pump installation or servicing well drilling activities, including pump installation and servicing, are supervised by an exam certified individual. Certification exams are administered by the National Ground Water Association (NGWA) and are available to be taken at PSI testing locations across New York State. You can contact PSI at www.psionline.com or 1-800-211-2754.
  - Prior to drilling any water well, you must file a Preliminary Notice with NYSDEC. This form can be completed online or downloaded from the Water Well Program website at www.dec.ny.gov/lands/5347.html. Paper copies of this form are available at no cost from our office.
  - Upon completion of the drilling of any well, you must: 1) file a Water Well Completion Report with NYSDEC and 2) provide a copy of such completion report to the water well owner. Completion Reports should be provided to NYSDEC and the well owner within 30 days of the well's completion. This form is available at no cost from our office.
- Please be advised, failure to comply with the above requirements is a violation of Article 15 of the NYS ECL and pursuant to ECL §71-1116 and §71-1127, subjects you to criminal fines of up to one thousand dollars (\$1,000) as well as civil penalties of up to one thousand five hundred dollars (\$1,500).

If you have any questions, please call our office toll free at 1-877-472-2619.

Sincerely,

  
Daniel Kendall  
NYSDEC, Water Well Program

Enclosures



As set forth under New York State Environmental Conservation Law, Section 15-1525

**Miller Environmental Group**  
Registration# NYRD01556

is hereby registered with

the Commissioner of the State Department of Environmental Conservation

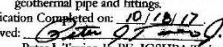
to drill or repair water wells in the State of New York only when supervised on-site by an individual who is exam certified in the respective water well activity. In accordance with the law and prior to commencement of drilling of any water well or wells, registrant shall file a preliminary notice with the Department. Registrant, as required, upon completion of the drilling of any well(s), to file a completion report with the Department, giving the log of the well, the size and depth thereof, the capacity of the pump or pumps attached or to be attached thereto, and such other information pertaining to the withdrawal of water and operation of completed well(s) as the Department by its rules and regulations may require. The registration number granted by this certificate must be displayed on the well drilling machinery of this registrant. All water well drilling shall be performed in accordance with standards promulgated by the Commissioner of Health as Appendix 5-B under Public Health Law. Notice is hereby given that all activities authorized by this certificate are subject to the provisions of Article 36-A of the New York State General Business Law.

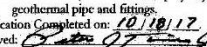
Registrant: Miller Environmental Group  
538 Edwards Ave  
Calverton, NY 11933

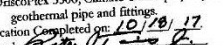
Issue Date: April 04, 2016  
Expiration Date: March 31, 2017

Authorized By:   
Mark Klotz, Director  
Division of Water

Rev 12/2014

This Hereby Confirms that **DAVE GOODWIN** has completed a basic study and training course on the principles and fundamentals of butt and socket fusion as outlined in the CPChem Performance Pipe "Heat Fusion Joining Procedures and Qualification Guide" for fusing DriscoPlex 5300, Climate Guard polyethylene geothermal pipe and fittings.  
Certification Completed on: 10/18/17  
Approved:   
Peter J. Tavino Jr. PE, IGSHPA Trainer

This Hereby Confirms that **CHARLES BOSS** has completed a basic study and training course on the principles and fundamentals of butt and socket fusion as outlined in the CPChem Performance Pipe "Heat Fusion Joining Procedures and Qualification Guide" for fusing DriscoPlex 5300, Climate Guard polyethylene geothermal pipe and fittings.  
Certification Completed on: 10/18/17  
Approved:   
Peter J. Tavino Jr. PE, IGSHPA Trainer

This Hereby Confirms that **DAVID E. BEARDON** has completed a basic study and training course on the principles and fundamentals of butt and socket fusion as outlined in the CPChem Performance Pipe "Heat Fusion Joining Procedures and Qualification Guide" for fusing DriscoPlex 5300, Climate Guard polyethylene geothermal pipe and fittings.  
Certification Completed on: 10/18/17  
Approved:   
Peter J. Tavino Jr. PE, IGSHPA Trainer

The International Ground Source Heat Pump Association hereby confirms **DAVID E. BEARDON** as an Individual Member (General Sector)  
Membership ID: 21719-0707 Expires: 12/31/2018  
Established Member Since: Jul 13, 2007

This Hereby Confirms that **SCOTT TEUSCHKE** has completed a basic study and training course on the principles and fundamentals of butt and socket fusion as outlined in the CPChem Performance Pipe "Heat Fusion Joining Procedures and Qualification Guide" for fusing DriscoPlex 5300, Climate Guard polyethylene geothermal pipe and fittings.  
Certification Completed on: 10/18/17  
Approved:   
Peter J. Tavino Jr. PE, IGSHPA Trainer





7.5. Exhibit E. Pre-Installation Submittal Data

Unicoil Submittal Data

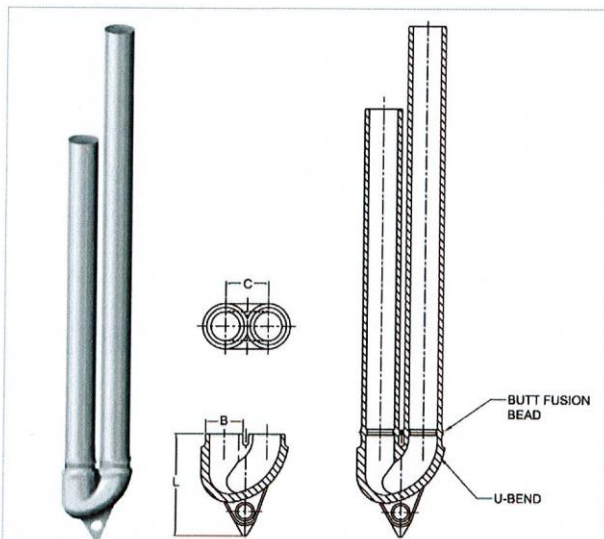
GEOTHERMAL



## OIL CREEK PLASTICS GEOTHERMAL LOOPS

**MEETS IGSHPA SPECIFICATIONS FOR GROUND HEAT EXCHANGER MATERIALS  
WITH 1-PIECE CENTRAL PLASTICS U-BEND PRE-INSTALLED**

Oil Creek Plastics geothermal pipe is manufactured from virgin high density PE-3608 or PE-4710 material designed to meet or exceed ASTM D 3035, and D 3350. Our geothermal pipe is guaranteed for life against rot, rust, electrolytic corrosion, and defects in both material and workmanship.

All geothermal loops with 1-piece u-bend pre-installed are butt fused by certified personnel and accomplished in accordance to the guidelines in the IGSHPA Installation Guide.





PE-4710 U-BENDS DIMENSIONS			
NOMINAL SIZE	B	C	L
3/4" IPS	1.05	1.75	3.84
1" IPS	1.31	1.82	3.84
1-1/4" IPS	1.66	1.91	4.55

GEOTHERMAL PIPE PE-3608 or PE-4710					
SIZE	O.D.	MINIMUM WALL	WEIGHT PER 100'	PSI RATING	
				PE-3608	PE-4710
<b>DR-11</b>					
3/4"	1.050	.095	12.9	160	200
1"	1.315	.120	20.0	160	200
1-1/4"	1.660	.151	31.4	160	200
<b>DR-9</b>					
3/4"	1.050	.117	15.3	200	250
1"	1.315	.146	23.5	200	250
1-1/4"	1.660	.184	37.2	200	250
1-1/2"	1.900	.211	48.7	200	250



NSF<sup>pw</sup>  
Potable water



Revision 5-1-12

Grout Submittal Data**GeoPro, Inc.****TG Select | PowerTEC | 1.40 Btu/hr-ft-°F****PRODUCT SUBMITTAL INFORMATION****PRODUCT MANUFACTURER & DESCRIPTION**

TG Select and PowerTEC are manufactured, distributed and supported by GeoPro, Inc.

When supplied by GeoPro and mixed according to our specifications, this TG Select and PowerTEC recipe will yield a bentonite-based thermal grout that provides an environmental seal in the bore annulus with the engineering properties described.

**PRODUCT PERFORMANCE & TECHNICAL DATA**

This product complies with IGSHA's Closed-Loop Design and Installation Standards which require:

- Permeability less than  $1.0 \times 10^{-7}$  cm/s per ASTM D-5084.
- Thermal conductivity tested per ASTM D-5334.
- Compliance with NSF/ANSI Standard 60 requirements for purity and suitability for contact with drinking water.

Properties and associated certifications are independently verified by a third party laboratory. Copies of independent test reports are available upon request.

**FIELD QUALITY CONTROL**

When using TG Select with PowerTEC, GeoPro strongly recommends a field quality control process consisting of:

- Thermal conductivity testing of grout samples
- Submission of material usage reports

Grout samples should be collected in the field and tested in a lab (per ASTM D-5334) to verify that the product meets minimum thermal performance requirements. Thermal conductivity testing is a free service that GeoPro provides. Sample containers are available upon request.

Material usage reports are available for download on our website. Contact us for more information.

**BATCH RECIPE**

TG Select	3	bag(s)
PowerTEC	2	bag(s)
Fresh Water*	51.0	gal
Yield	63.0	gal

\*Mix water must be suitable for human consumption

**GROUT PROPERTIES**

Target Thermal Conductivity	1.40	Btu/hr-ft-°F
Permeability	$<1 \times 10^{-7}$	cm/s
Density	10.1	lb/gal
Percent Solids	33.5	by weight
Percent Active Solids	26.1	by weight

**MIXING INSTRUCTIONS**

1. Fill conventional paddle mixer with 51.0 gal of fresh water (according to mix table). *Accurate mix water volume measurements are critical.*
2. Start mixer and add 2 bag(s) of PowerTEC.
3. Add 3 bag(s) of TG Select and mix until uniform (approx. 2-3 minutes).
4. Pump with a positive displacement pump (piston pump recommended) through a 1-¼ in tremie pipe.

**PACKAGING INFORMATION**

TG Select is packaged in 50 lb bags with 54 bags per heat shrunk pallet.

PowerTEC is packaged in 32 lb bags with 66 bags per heat shrunk pallet.

created: 2017-05-24

GeoPro, Inc.  
877-580-9348

302 East Warehouse  
Elkton, SD 57026

geoproinc.com

## Antifreeze Submittal Data

## Product Information

**DOWFROST****Inhibited Propylene Glycol-based Heat Transfer Fluid**

DOWFROST\* heat transfer fluid contains specially formulated packages of industrial inhibitors that help prevent glycol fluids have low acute oral toxicity, DOWFROST propylene glycol-based fluids are often used in applications where contact with food or beverage products could occur.

**Recommended use temperature range:** -45°C (-50°F) to 120°C (250°F)

**Suitable applications:** secondary cooling and heating, freeze and burst protection of pipes, various deicing, defrosting, and dehumidifying.

For health and safety information for this product, contact your Dow sales representative or call the number for your area on the second page of this sheet for a Material Safety Data Sheet (MSDS).

**Typical Concentrations of DOWFROST Fluid Required to Provide Freeze and Burst Protection at Various Temperatures**

Temperature °C (F°)	Percent DOWFROST Fluid Concentration Required	
	For Freeze Protection Volume %	For Burst Protection Volume %
-7 (20)	18	12
-12 (10)	29	20
-18 (0)	36	24
-23 (-10)	42	28
-29 (-20)	46	30
-34 (-30)	50	33
-40 (-40)	54	35
-46 (-50)	57	35
-51 (-60)	60	35

**NOTE:** These figures are examples only and may not be appropriate to your situation. Generally, for an extended margin of protection, you should select a temperature in this table that is at least 3°C (5°F) lower than the expected lowest ambient temperature. Inhibitor levels should be adjusted for solutions of less than 30% glycol. Contact Dow for information on specific cases or further assistance.

**ATTENTION:** These are typical numbers only and are not to be regarded as specifications. As use conditions are not within its control, Dow does not guarantee results from use of the information or products herein; and gives no warranty, express or implied.

**Typical Freezing and Boiling Points of DOWFROST Fluid<sup>†</sup>**

Wt. % Propylene Glycol	Vol. % Propylene Glycol	Wt. % DOWFROST	Vol. % DOWFROST	Freezing Point °C (°F)	Boiling Point °C @ 101 kPa (°F @ 760 mmHg)	Degree Brix <sup>††</sup>	Refractive Index 22°C (72°F)
0.0	0.0	0.0	0.0	0 (32.0)	100.0 (212)	0.0	1.3328
5.0	4.8	5.2	5.2	-1.6 (29.1)	100.0 (212)	4.8	1.3383
10.0	9.6	10.5	10.0	-3.3 (26.1)	100.0 (212)	8.4	1.3438
15.0	14.5	15.7	15.1	-5.1 (22.9)	100.0 (212)	12.9	1.3495
20.0	19.4	20.9	20.3	-7.1 (19.2)	100.6 (213)	15.4	1.3555
25.0	24.4	26.1	25.5	-9.6 (14.7)	101.1 (214)	19.0	1.3615
30.0	29.4	31.4	30.7	-12.7 (9.2)	102.2 (216)	22.0	1.3675
35.0	34.4	36.6	36.0	-16.4 (2.4)	102.8 (217)	26.1	1.3733
40.0	39.6	41.8	41.4	-21.1 (-6.0)	103.9 (219)	29.1	1.3790
45.0	44.7	47.0	46.7	-26.7 (-16.1)	104.4 (220)	31.8	1.3847
50.0	49.9	52.3	52.2	-33.5 (-28.3)	105.6 (222)	34.7	1.3903
55.0	55.0	57.5	57.5	-41.6 (-42.8)	106.1 (223)	38.0	1.3956
60.0	60.0	62.7	62.7	-51.1 (-59.9)	107.2 (225)	40.6	1.4008
65.0	65.0	68.0	68.0	a	108.3 (227)	42.1	1.4058
70.0	70.0	73.2	73.2	a	110.0 (230)	44.1	1.4104
75.0	75.0	78.4	78.4	a	113.9 (237)	46.1	1.4150
80.0	80.0	83.6	83.6	a	118.3 (245)	48.0	1.4193
85.0	85.0	88.9	88.9	a	125.0 (257)	50.0	1.4235
90.0	90.0	94.1	94.1	a	132.2 (270)	51.4	1.4275
95.0	95.0	99.3	99.3	a	154.4 (310)	52.8	1.4315

<sup>†</sup> Typical properties, not to be construed as specifications

<sup>††</sup> Degree Brix is a measure of the sugar concentration in a fluid and is important in fermentation and syrups applications. Although there is no sugar present in DOWFROST heat transfer fluids, the glycol affects the refractive index of the fluid in a similar fashion.

<sup>a</sup> Freezing points are below -50°C (-60°F).

**NOTE:** Generally, for an extended margin of protection, you should select a temperature in this table that is at least 3°C (5°F) lower than the expected lowest ambient temperature. Inhibitor levels should be adjusted for solutions of less than 30% glycol. Contact Dow for information on specific cases or further assistance.

\*Trademark of The Dow Chemical Company

## 7.6 Exhibit F. Flushing Velocity Calculations & Flushing Inspection Form

### Fluid Velocity Calculation

0

$$V = \frac{0.4085 Q}{D_i^2}$$

Inputs:

Q  gpm

HDPE

V=  Ft./sec.

### GPM Calculation

$$Q \text{ (gpm)} = \frac{2 \text{ ft/sec} * D_i^2}{0.4085}$$

Inputs:

HDPE

Q=  gpm  
(Min. Flow to Produce 2 Ft./sec.)





7.7 Exhibit G- Flow Test Calculation and Inspection Form.

National Grid Field Pressure Drop- Recalculated from As-built  
11/19/2017

Flow Test Calculations @ 90 gpm

Water @ 60F	Density(lbm/ft^3)=	62.4	Viscosity(cp)=	1.14		
<u>Qty</u>	<u>Pipe or Fitting</u>	<u>GPM</u>	<u>Length or Leq</u>	<u>Head Loss per 100'</u>	<u>Head Loss</u>	
2	3" HDPE SDR 11 Pipe	90	4	2.6	0.21	
4	3" HDPE Butt Elbow	90	32	2.6	3.33	
2	3" HDPE EF Tee	90	6.8	2.6	0.35	
2	3" HDPE SDR 11 Pipe	85.5	10	2.36	0.47	
2	3" HDPE EF Tee	85.5	6.8	2.36	0.32	
2	3" HDPE SDR 11 Pipe	81	10	2.14	0.43	
2	3" HDPE EF Tee	81	6.8	2.14	0.29	
2	3" HDPE SDR 11 Pipe	76.5	10	1.93	0.39	
2	3" HDPE EF Tee	76.5	6.8	1.93	0.26	
2	3" HDPE SDR 11 Pipe	72	10	1.73	0.35	
2	3" HDPE EF Tee	72	6.8	1.73	0.23	
2	3" HDPE SDR 11 Pipe	67.5	10	1.53	0.31	
2	3" HDPE EF Tee	67.5	6.8	1.53	0.21	
2	3" HDPE SDR 11 Pipe	63	10	1.35	0.27	
2	3" HDPE EF Tee	63	6.8	1.35	0.18	
2	3" HDPE SDR 11 Pipe	58.5	10	1.18	0.24	
2	3" HDPE EF Tee	58.5	6.8	1.18	0.16	
2	3" HDPE SDR 11 Pipe	54	10	1.02	0.2	
2	3" HDPE EF Tee	54	6.8	1.02	0.14	
2	3" HDPE SDR 11 Pipe	49.5	10	0.87	0.17	
2	3" HDPE EF Tee	49.5	6.8	0.87	0.12	
2	3" HDPE SDR 11 Pipe	45	10	0.74	0.15	
2	3" HDPE EF Tee	45	6.8	0.74	0.1	
2	3" HDPE SDR 11 Pipe	40.5	10	0.61	0.12	
2	3" HDPE EF Tee	40.5	6.8	0.61	0.08	
2	3" HDPE SDR 11 Pipe	36	10	0.49	0.1	
2	3" HDPE EF Tee	36	6.8	0.49	0.07	
2	3" HDPE SDR 11 Pipe	31.5	10	0.39	0.08	
2	3" HDPE EF Tee	31.5	6.8	0.39	0.05	
2	3" HDPE SDR 11 Pipe	27	10	0.29	0.06	
2	3" HDPE EF Tee	27	6.8	0.29	0.04	
2	3" HDPE SDR 11 Pipe	22.5	10	0.21	0.04	
2	3" HDPE EF Tee	22.5	6.8	0.21	0.03	
2	3" HDPE SDR 11 Pipe	18	10	0.14	0.03	
2	3" HDPE EF Reducer	18	10.3	0.92	0.19	
2	2" HDPE Socket Tee Branch	18	13	0.92	0.24	
2	2" HDPE SDR 11 Pipe	13.5	10	0.55	0.11	
2	2" HDPE Butt Reducer	13.5	6.8	1.63	0.22	
2	1 1/2" HDPE Socket Tee Branch	13.5	10	1.63	0.33	
2	1 1/2" HDPE SDR 11 Pipe	9	10	0.79	0.16	
2	1 1/2" HDPE Socket Reducer	9	3.9	1.51	0.12	
2	1 1/4" HDPE Socket Tee Branch	9	6.4	1.51	0.19	
1	1 1/4" HDPE SDR 11 Pipe	4.5	450	0.44	1.99	
1	1-1/4" U-Bend	4.5	10.2	0.43	0.18	
1	3" HDPE SDR 11 Pipe	90	200	2.6	5.2	
2	3" HDPE Butt Elbow	90	32	2.6	1.66	
						20.17 ft. hd.
						8.73 psi

Flow Test Inspection Form

**IMC1208 Flow Testing Summary**

Project Name: Glenwood Village  
 Project Address: 1661 Old Country Road, Riverhead, NY 11901  
 Contractor: Miller Environmental Group, Inc.  
 Inspector: John Turley, GreyEdge Group, LLC, IGSHPA CGI #0101

Metering Device: Ultrasonic  
 Fluid Type: Water

Pipe Section	Approx. Volume (Gal.)	Design Flow (GPM)	Design PD (ft/hd)	Ambient Temp (F)	Design PD (PSI)	Min PD Design -10% (PSI)	Max PD Design +10% (PSI)	Best Field PD (PSI)	% High or Low (+/-)	Result	Witness	Date
Borefield	850	90	20.17	45	8.73	7.86	9.69	8.0	-8.4%	PASS	<i>John D. Turley</i>	<i>4/30/2018</i>
					0.00	0.00	0.00					
					0.00	0.00	0.00					
					0.00	0.00	0.00					
					0.00	0.00	0.00					
					0.00	0.00	0.00					
					0.00	0.00	0.00					
					0.00	0.00	0.00					
					0.00	0.00	0.00					
					0.00	0.00	0.00					
					0.00	0.00	0.00					
					0.00	0.00	0.00					
					0.00	0.00	0.00					
					0.00	0.00	0.00					
					0.00	0.00	0.00					
					0.00	0.00	0.00					
					0.00	0.00	0.00					
					0.00	0.00	0.00					



7.8 Exhibit H- Pressure Test Inspection Forms.

**ASTM F2164-13 Pressure Testing Summary**

Project Name: Glenwood Village  
 Contractor: Miller Environmental Group  
 Inspector: DAVID EASON

Depth of installed loops: 285'  
 Depth of Horizontal Piping: 4'-4.5'  
 Backfill Materials Used: GRAVEL / FREE FROM STONES / DEBRIS  
 Type of Test: SWAB WITH HD / PRESSURED WITH AIR  
 Target Pressure: 100 psi  
 Duration: 1 hr  
 Pass Range: 95 psi - 105 psi

Pipe Section- Circuit, Mains, etc	Reading 1		Reading 2		Reading 3		Reading 4		Reading 5		Result	Witness	Date
	Time	Pressure (PSI)	Time	Pressure (PSI)	Time	Pressure (PSI)	Time	Pressure (PSI)	Time	Pressure (PSI)			
<u>Loop Field w/E Mainlines</u>	<u>14:32</u>	<u>105</u>	<u>14:43</u>	<u>104.5</u>	<u>14:54</u>	<u>104.5</u>	<u>15:05</u>	<u>104.5</u>	<u>15:21</u>	<u>105</u>	<u>S</u>	<u>Scott T. Nels</u>	<u>11/17/2017</u>

**ASTM F2164-13 PRESSURE TESTING**



**ASTM F2164-13 Pressure Testing Summary**

Project Name: Glenwood Village  
 Contractor: Miller Environmental  
 Inspector: John Toney, GreyEdge Group LLC  
 Date: 11/29/17  
 Backfill Materials Used: Dan Godwin / MEC

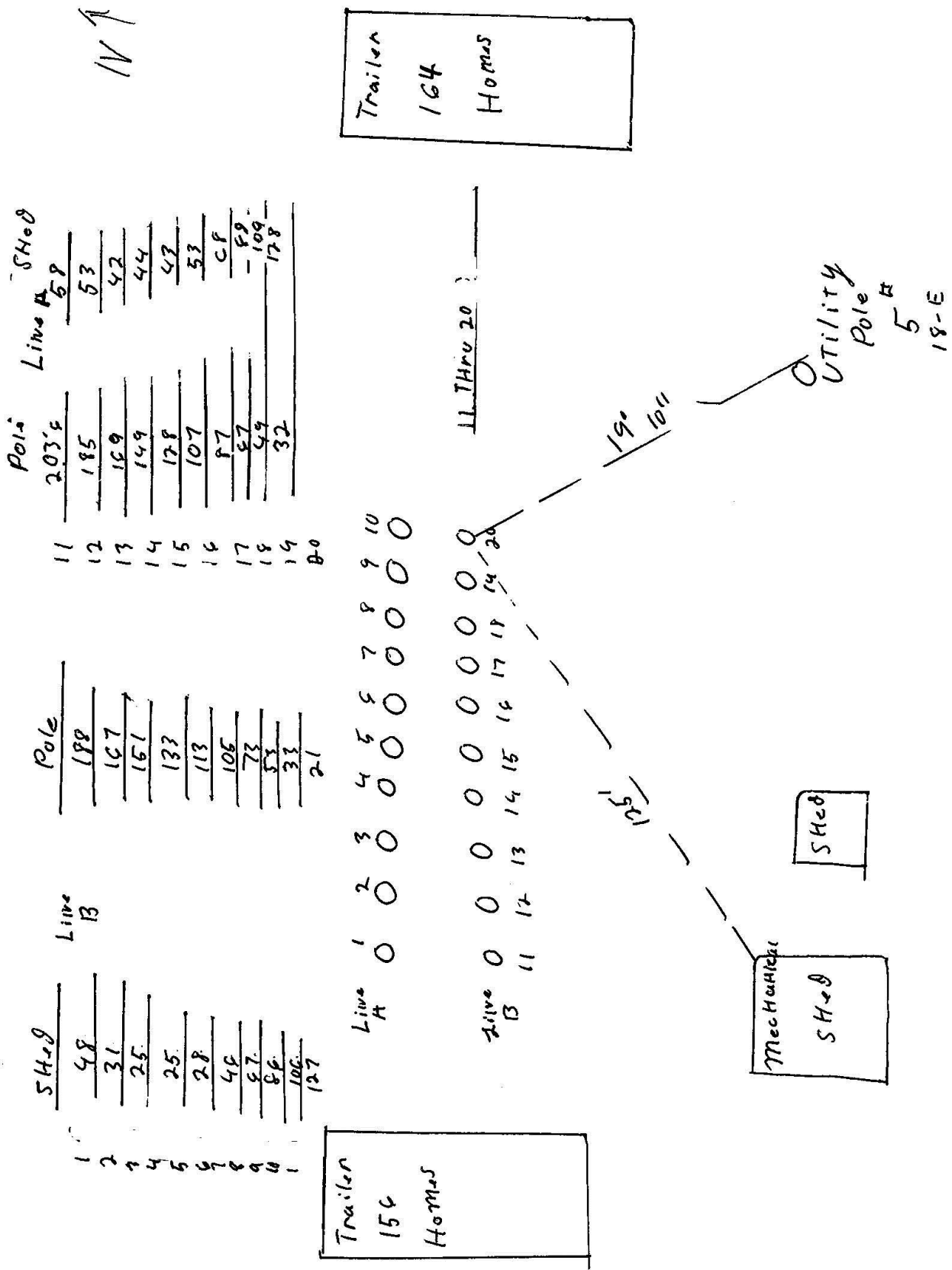
Depth of Installed Loops: 225'  
 Depth of Horizontal Piping: 4-4.5'  
 Type of Test: Native  
 Target Pressure: 100 psi  
 Actual Start Pressure: 102  
 Final Pressure by Air  
 Duration: 1 hr  
 Pass Range: 95 psi - 105 psi

Pipe Section- Circuit, Mains, etc	Reading 1		Reading 2		Reading 3		Reading 4		Reading 5		Result	Witness	Date
	Time	Pressure (PSI)	Time	Pressure (PSI)	Time	Pressure (PSI)	Time	Pressure (PSI)	Time	Pressure (PSI)			
Loop + Latrinal Runs to the House (with Isolated Air to Foundation & Inlet Components Abstracted For 100psi Range)	11:23	102	11:42	102	11:51	101.5	12:02	101	12:37	100.5	P	Dan Godwin Charles Ross Scott Tessdale 11/29/17	11/29/17



7.9 Exhibit I- As-built Information.

Point	Degrees	
	Lat	Long
1	40°55'13.31"N	72°41'48.26"W
2	40°55'13.27"N	72°41'47.90"W
3	40°55'13.267"N	72°41'47.6395"W
4	40°55'13.2582"N	72°41'47.3792"
5	40°55'13.07"N	72°41'47.30"W
6	40°55'12.953"N	72°41'47.09"W
7	40°55'12.94"N	72°41'46.83"W
8	40°55'12.94"N	72°41'46.61"W
9	40°55'12.79"N	72°41'46.45"W
10	40°55'12.63"N	72°41'46.26"W
11	40°55'12.42"N	72°41'46.31"W
12	40°55'12.5"N	72°41'46.56"W
13	40°55'12.58"N	72°41'46.81"W
14	40°55'12.7"N	72°41'47.095"W
15	40°55'12.76"N	72°41'47.22"W
16	40°55'12.82"N	72°41'47.38"W
17	40°55'12.95"N	72°41'47.60"W
18	40°55'12.90"N	72°41'47.88"W
19	40°55'12.94"N	72°41'48.18"W
20	40°55'12.89"N	72°41'48.48"W

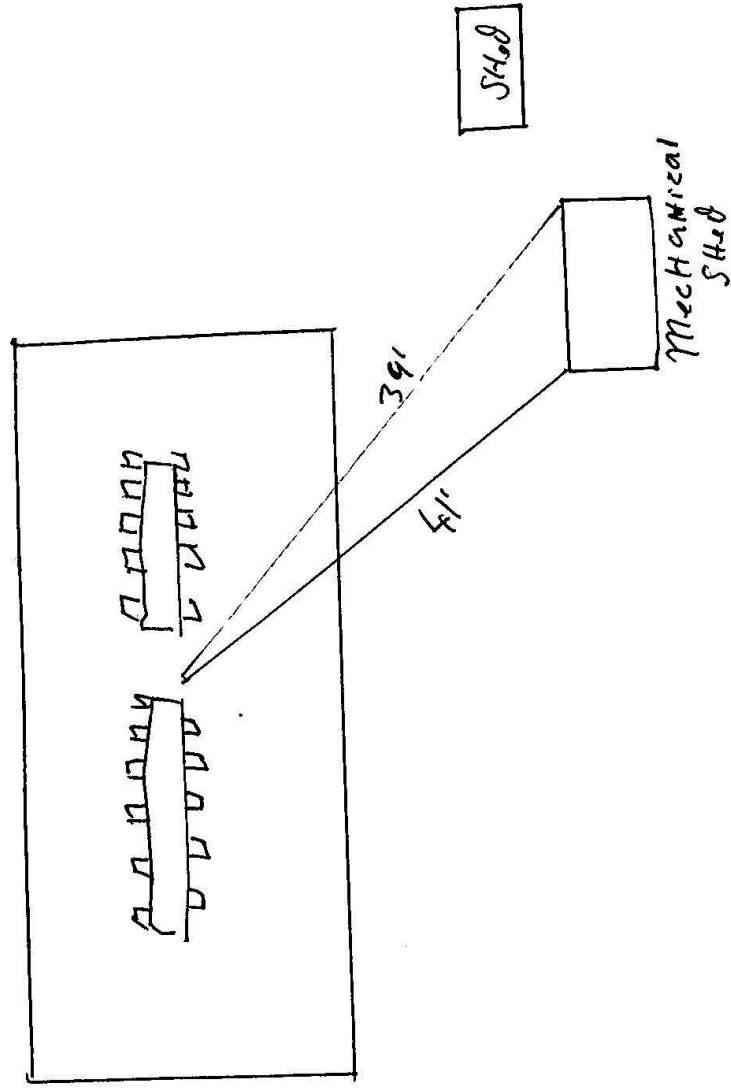


↑ N

5 ↓

G-17-0040

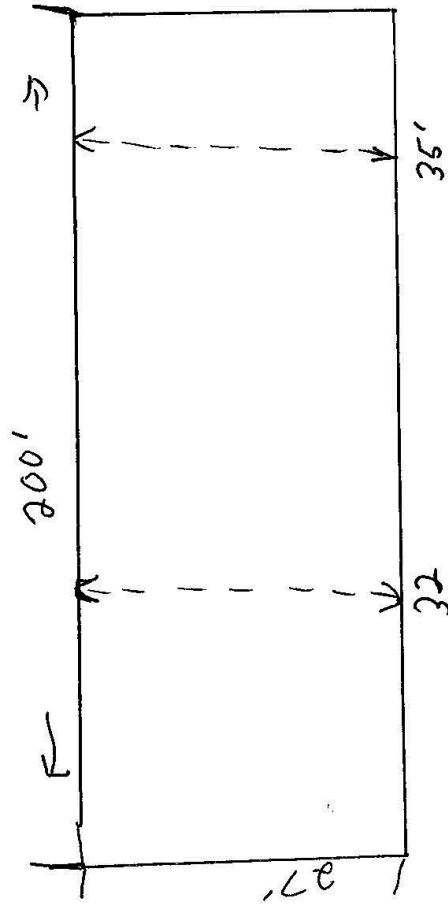
Main Fold Center



G-17-0046

N ↑  
E ↑  
S ↓

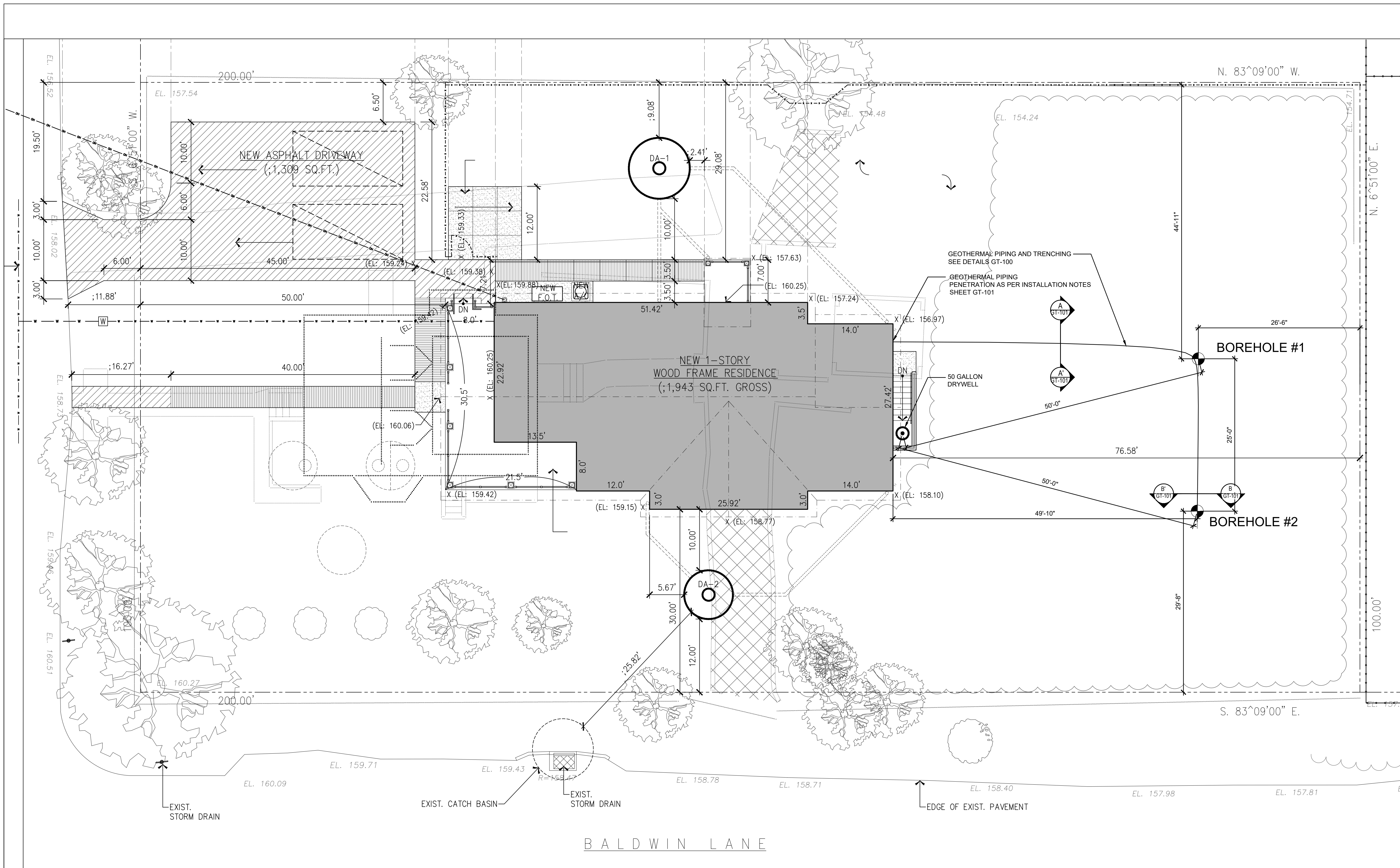
Loop Field



2-17-0040



Appendix C  
Medford Site Design



SOURCE DRAWING:  
 DRAWING: ST-1- SITE DEVELOPMENT PLAN  
 FUSION ARCHITECTURE  
 ONE FAIRCHILD COURT, SUITE 130  
 PLAINVIEW, NY 11803

NOTE: INFORMATION FOR ST-1 FROM  
 SURVEY PREPARED BY:  
 DONALD G. DEKNENIPP, LS, PC  
 SAYVILLE, NY

NOTES:

- BOREHOLE LOCATIONS SELECTED TO PROVIDE MINIMUM SETBACKS AS PER TOWN CODE. SEE TABLE THIS SHEET.
- GEOHERMAL BOREHOLES INSTALLED TO 260' BENEATH GRADE. SEE SHEET GT-101 AND GT-102 FOR GEOHERMAL INSTALLATION REQUIREMENTS.

### GEOHERMAL SITE PLAN

TOWN OF BROOKHAVEN GEOHERMAL SETBACK COMPLIANCE TABLE  
 (CLOSED LOOP GEOHERMAL SETBACK REQUIREMENTS AS PER SECTION  
 85-808 & 85-810 OF TOWN CODE)

ITEM	REQUIREMENT	PROPOSED
FOUNDATION	10FT	49FT
PROP. LINE	25FT	26FT (MIN. SEE PLAN)
UNDGRND FUEL TANK	25FT	N/A
STORMWATER	50FT	50FT
SEWAGE DISPOSAL	50FT	N/A
UTILITY		
WATER	10FT	>50FT
SEWERS	10FT	N/A
UTILITIES(MISC)	10FT	N/A

General Notes

CONSULTANTS:



UNAUTHORIZED ADDITION OR ALTERATION OF THIS DRAWING OR RELATED DOCUMENTS IS A VIOLATION OF SECTION 7209 OF THE NEW YORK STATE EDUCATION LAW

R2	FOR BUILDING DEPT	02/02/18
R1	FOR APPROVAL	12/26/17
No.	Revision/Issue	Date

Firm Name and Address  
**RENU Engineering Technologies, PC**  
 15 RIVER ROAD, SUITE 15B  
 WILTON, CT 06897  
 203.664.1312  
 info@RENUet.com

Project Name and Address  
**UNITED WAY GEOTHERMAL SYSTEM**  
 6 HAWKINS AVENUE, MEDFORD NY

Project	ZBF-1703	Sheet	GT-100
Date	12-01-17		
Scale	1/8" = 1'-0"		





### Project Summary Entire House

Job: Jul 03, 2017  
By: Brendan Nickel

#### Project Information

For: Hawkins Ave. Association For Mental Health And Wellness  
6 Hawkins Ave, Medford, NY 11763

Notes:

#### Design Information

Weather: Islip Long Isl MacArthur AP, NY, US

##### Winter Design Conditions

Outside db 15 °F  
Inside db 70 °F  
Design TD 55 °F

##### Summer Design Conditions

Outside db 86 °F  
Inside db 75 °F  
Design TD 11 °F  
Daily range 1 °F  
Relative humidity 50 %  
Moisture difference 32 gr/lb

##### Heating Summary

Structure 11014 Btuh  
Ducts 4502 Btuh  
Central vent (SER=50% 118 cfm) 3541 Btuh  
Energy recovery  
Humidification 0 Btuh  
Piping 0 Btuh  
Equipment load 19058 Btuh

##### Sensible Cooling Equipment Load Sizing

Structure 14927 Btuh  
Ducts 3458 Btuh  
Central vent (SER=50% 118 cfm) 684 Btuh  
Energy recovery  
Blower 0 Btuh  
Use manufacturer's data n  
Rate/swing multiplier 0.91  
Equipment sensible load 17275 Btuh

##### Infiltration

Method Construction quality  
Fireplaces Simplified Tight 0

##### Latent Cooling Equipment Load Sizing

Structure 2033 Btuh  
Ducts 477 Btuh  
Central vent (LER=50% 118 cfm) 1288 Btuh  
Energy recovery  
Equipment latent load 3798 Btuh  
Equipment Total Load (Sen+Lat) 21073 Btuh  
Req. total capacity at 0.70 SHR 2.1 ton

##### Heating Equipment Summary

Make WaterFurnace  
Trade 7 Series  
Model NVV036  
AHRI ref 5677290  
Efficiency 5.47 COP  
Heating input 14.7 kW  
Heating output 50000 Btuh  
Temperature rise 55 °F  
Actual air flow 832 cfm  
Air flow factor 0.054 cfm/Btuh  
Static pressure 0 in H2O  
Space thermostat  
Capacity balance point = 0 °F

##### Cooling Equipment Summary

Make WaterFurnace  
Trade 7 Series  
Cond NVV036  
Coil AHRI ref 5677290  
Efficiency 22 EER  
Sensible cooling 25200 Btuh  
Latent cooling 10800 Btuh  
Total cooling 36000 Btuh  
Actual air flow 832 cfm  
Air flow factor 0.045 cfm/Btuh  
Static pressure 0 in H2O  
Load sensible heat ratio 0.83

Calculations approved by ACCA to meet all requirements of Manual J 8th Ed.

wrightsoft Right-Sublet Unit ensal 2017 17.0.29 FSU26191 2017-Dec-18 19:06:34  
Page 1

### MANUAL J LOAD CALCULATION

GeoLink Design Studio



#### Ground Source System 1 Performance Summary

7 Series Variable Capacity 7 Series NV036 with Vertical 1 U-Bend - 1.00" PE

##### WaterFurnace System -

WaterFurnace Series: 7 Series Variable Capacity  
WaterFurnace Unit: 7 Series NV036  
Geo Unit Cooling Run Time: 871 hours  
Geo Unit Heating Run Time: 3,453 hours  
High Speed Cooling Runtime: 14 %  
High Speed Heating Runtime: 6 %  
Hbt Water Generation Option: Electric with Geo Assist  
Max System Balance Point: 0.0 °F  
Avg. System Balance Point: 0.0 °F  
Summer Peak Demand: 2.1 kW  
Winter Peak Demand: 1.5 kW

##### Auxiliary Heat -

Auxiliary Heat Type: Electric - internal duct heat  
Furnace Fuel: Electric  
Auxiliary Heat Required: 0 kW  
Optional Emergency Heat Size: 10.6 kW

##### GeoThermal Loop System -

Loop Type: Vertical 1 U-Bend 1.00" PE  
Soil Type: Sand/Gravel - Saturated  
Average Depth: 150.0 ft  
Trench/Bore: 300 ft  
Freeze Protection Minimum: 26.0 °F  
Max Geo Extreme Temp: 87.6 °F  
Average Cq Loop Temp: 61.1 °F  
Average Hg Loop Temp: 50.4 °F  
Min Geo Extreme Temp: 30.4 °F  
Geo Temp Min-Max: 30.0 - 90.0 °F  
Deep Earth Temp: 64.0 °F  
Surface Swing: 22.0 °F  
Ground Lag Time: 38 Days  
Soil Conductivity: 1.44  
Soil Diffusivity: 0.86

##### Design Data -

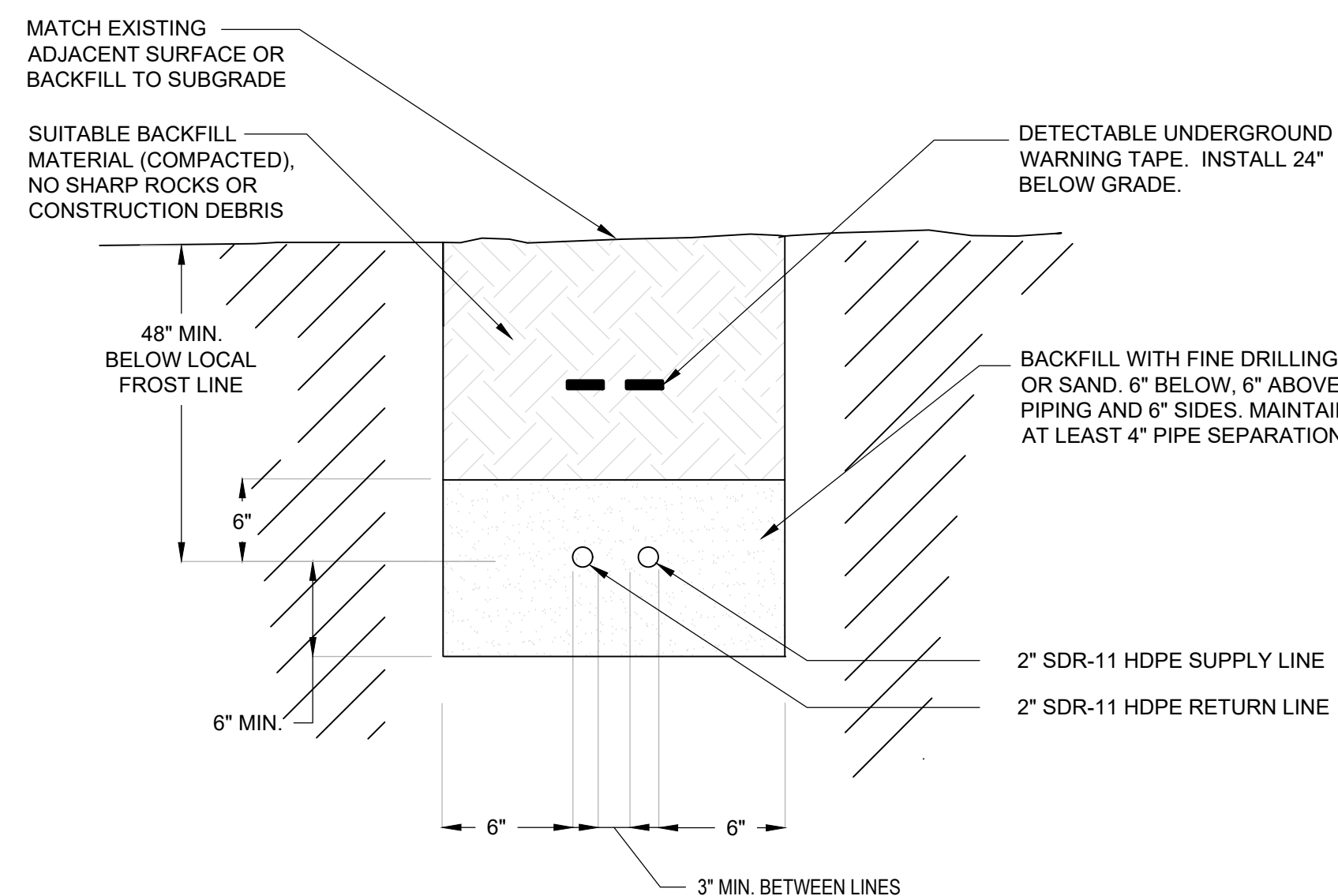
Design Heating Load: 19,058 Btuh  
Design Heating Temp Difference: 55.0 °F  
Design Cooling Load: 21,073 Btuh  
Design Cooling Temperature Difference: 11.0 °F  
Hbt Water Temperature Setting: 120 °F  
Hbt Water Users: 4  
Continuous Fan: No  
Internal Gains: 4,058 Btuh

##### Comfort Conditions -

Heating Set Point: 70 °F  
Cooling Set Point: 75 °F  
Start Cooling Temperature: 75 °F  
Weather Location: NEW YORK, NY

Due to variability in system installation, weather, and individual units, this analysis is to be considered an estimate.

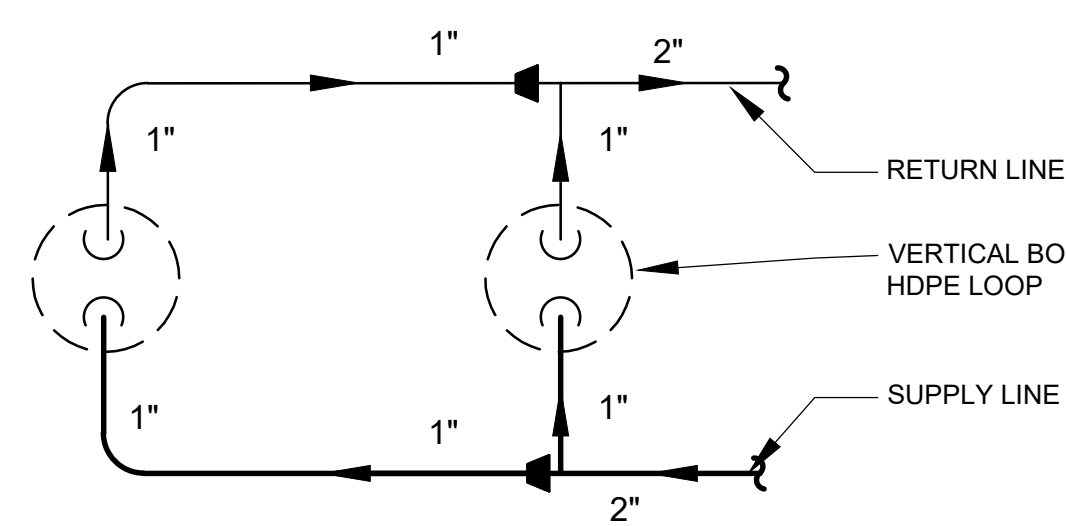
### GEOHERMAL DESIGN PERFORMANCE SUMMARY



#### NOTE

- IF DEPTH OF TRENCH EQUALS OR EXCEEDS 5'-0", THE CONTRACTOR MUST PROVIDE SHEETING AND BRACING. AS AN ALTERNATIVE, THE TRENCH WALLS MUST BE CUT BACK TO A 1:1 SLOPE, OR THE NATURAL ANGLE OF REPOSE FOR THE SOIL, WHICHEVER IS MORE SHALLOW.
- CLASS I, II, III OR IV COMPACTED BACKFILL MATERIAL IN ALL PIPE ZONES, PER USCS UNIFIED SOIL CLASSIFICATION SYSTEM)

### GEOHERMAL TRENCH DETAIL SECTION A-A' NOT TO SCALE

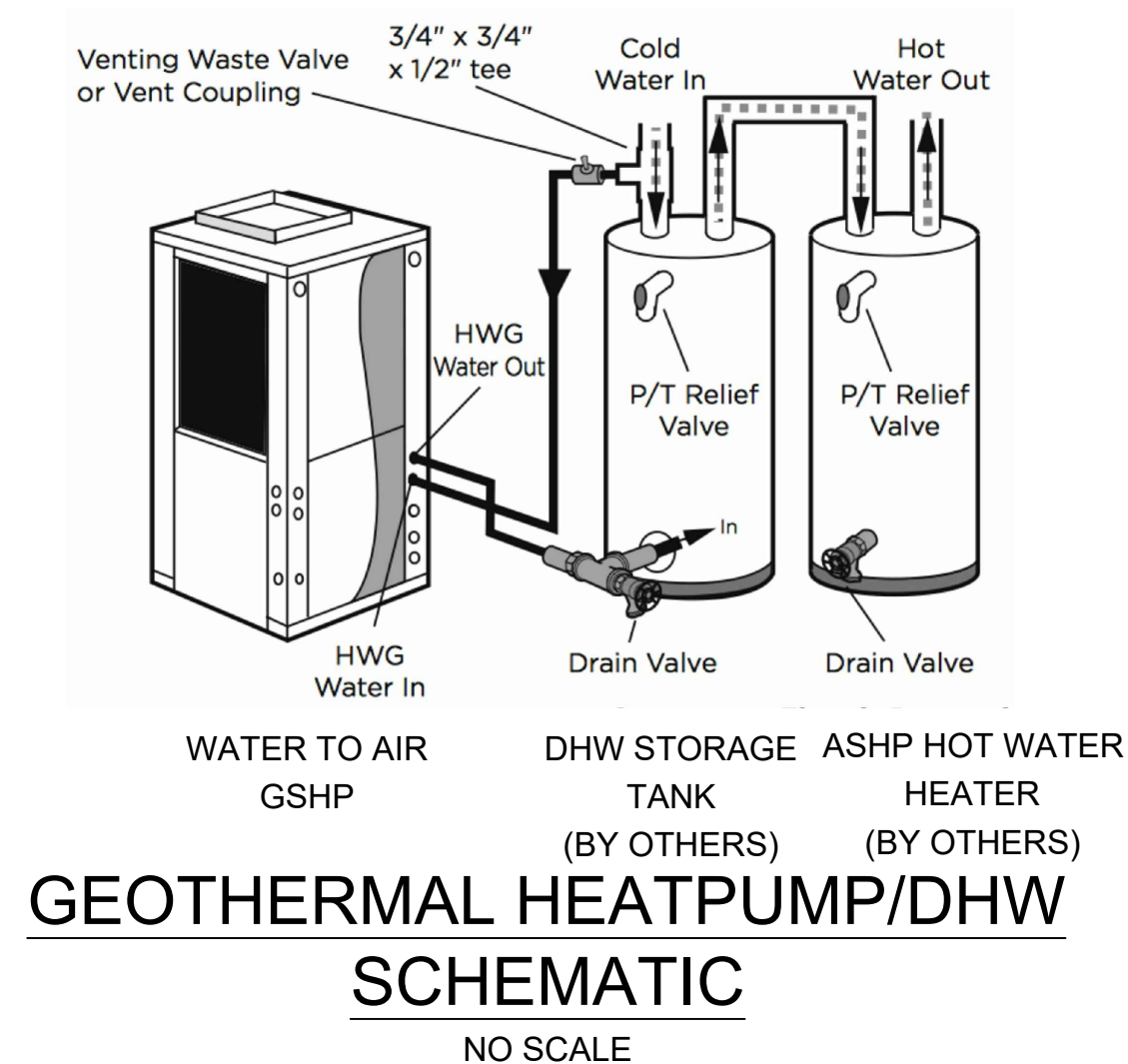


### GEOHERMAL BOREHOLE PIPING SCHEMATIC NO SCALE

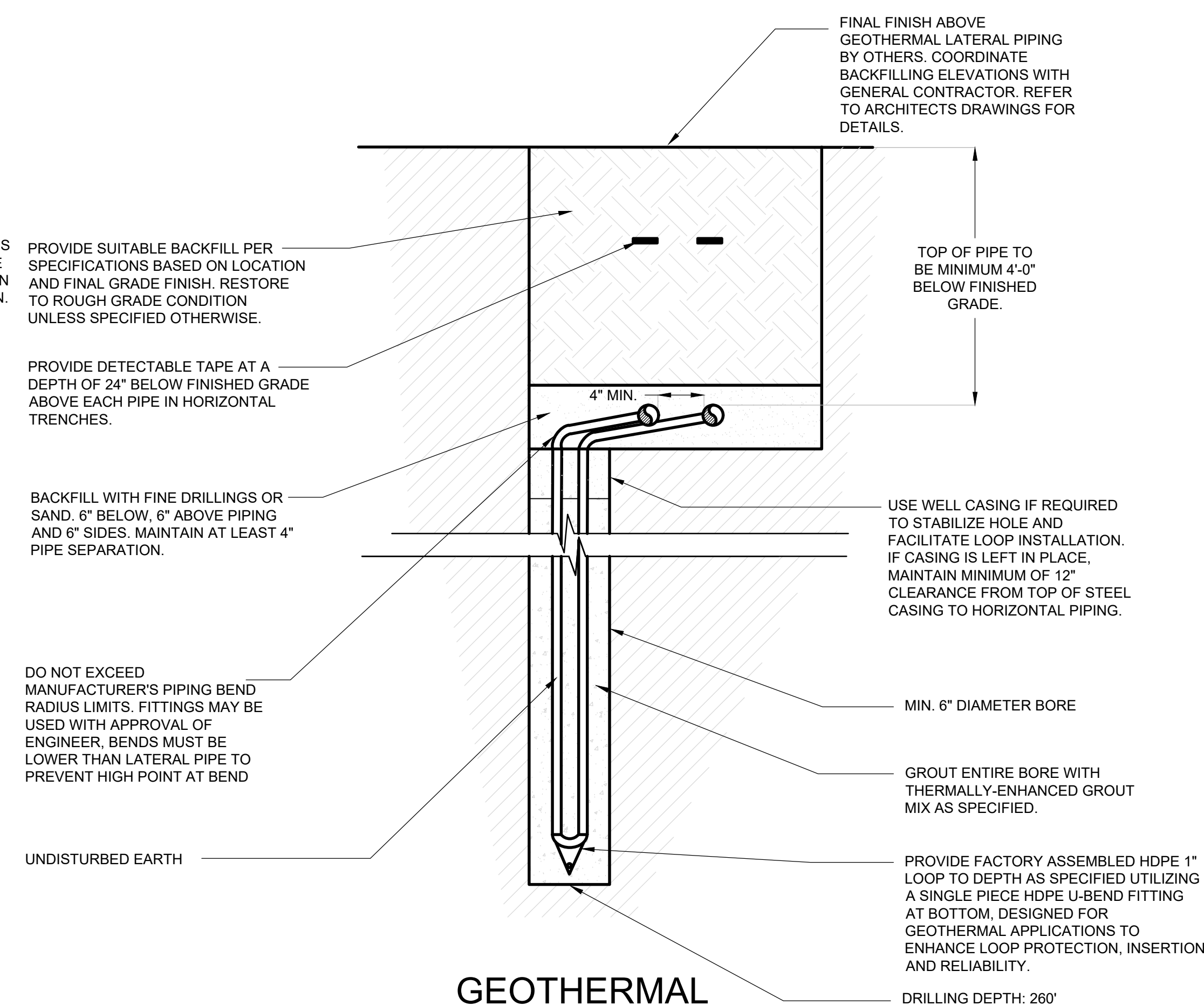
#### Geothermal Equipment Schedule

Unit #	Manufacture	Model #	Tonage	Area Served	Unit Location	Voltage	MCA	Max Fuse Size
GEO-1	WaterFurnace	NVH036	3	First Floor	Basement	208/230/1	37.3 amps	40 amps
(10kW Emergency Heat Element)	WaterFurnace	EAL10A				208/230/1	53.3 amps	60 amps
Circulator Pump Schedule		Manufacture	Model #	Voltage	Amps			
FC-1	GeoFlo	Geo-Magna NPV	(32-140)	220v	0.97			

### GEOHERMAL HEAT PUMP SCHEDULE



### GEOHERMAL HEATPUMP/DHW SCHEMATIC NO SCALE



### GEOHERMAL BOREHOLE DETAIL SECTION B-B' NOT TO SCALE

General Notes

CONSULTANTS:



UNAUTHORIZED ADDITION OR ALTERATION OF THIS DRAWING OR RELATED DOCUMENTS IS A VIOLATION OF SECTION 7209 OF THE NEW YORK STATE EDUCATION LAW

R2	FOR BUILDING DEPT	02/02/18
R1	FOR APPROVAL	12/26/17
No.	Revision/Issue	Date

Firm Name and Address  
**RENU Engineering Technologies, PC**  
15 RIVER ROAD, SUITE 15B  
WILTON, CT 06897  
203.664.1312  
info@RENUet.com

Project Name and Address  
**UNITED WAY GEOHERMAL SYSTEM**  
6 HAWKINS AVENUE, MEDFORD NY

Project	ZBF-1703	Sheet	GT-101
Date	12-01-17		
Scale			



## GEOTHERMAL SPECIFICATIONS

### PART I: GENERAL

- A. **SCOPE OF WORK:** THE PROJECT AS SPECIFIED REQUIRES THE INSTALLATION OF A CLOSED LOOP GEOTHERMAL HVAC SYSTEM. IT INCLUDES A TOTAL OF TWO (2) GEOTHERMAL BOREHOLES. THE BOREHOLE LOOPS ARE TO BE CONNECTED AND RUN TO THE HOUSE AS SHOWN IN THE PROJECT DETAILS. THE LOOPS ARE CONNECTED TO A NON-PRESSURIZED FLOW CENTER WHICH CIRCULATES LOOP FLUID BETWEEN THE LOOPS AND THE GEOTHERMAL HEAT PUMP. THE GEOTHERMAL HEAT PUMP SYSTEM PROVIDES CONDITIONED AIR TO THE HOUSE DUCT WORK. A DESUPERHEATER IS INSTALLED IN THE HEAT PUMP AND SUPPLEMENTS HEAT TO THE ASHP DOMESTIC HOT WATER (DHW) HEATER.
- B. **GEOTHERMAL COSE COMPLIANCE:** ALL GEOTHERMAL WORK SHALL COMPLY WITH SECTION 85-808, 85-809 AND 85-810 OF THE TOWN OF BROOKHAVEN RENEWABLE ENERGY SYSTEM CODES, INTERNATIONAL GROUND SOURCE HEAT PUMP ASSOCIATION (IGSHPA) AND NYS DEPARTMENT OF ENVIRONMENTAL CONSERVATION (NYSDEC) CODES. ALL WORK SHALL COMPLY WITH APPLICABLE TOWN OF BROOKHAVEN, NEW YORK STATE AND NATIONAL ELECTRICAL CODES. ALL ELECTRICAL AND PLUMBING IS BY OTHERS.
- C. **CONTRACTOR REQUIREMENTS:** THE CONTRACTOR IS REQUIRED TO BE AN ACCREDITED GEOTHERMAL SYSTEM INSTALLER AND HAVE CURRENT CERTIFICATIONS FROM IGSHPA. THE CONTRACTOR MUST HAVE A MINIMUM OF 5 GEOTHERMAL INSTALLATIONS OF SIMILAR SCOPE WITHIN THE LAST 12 MONTHS. THE CONTRACTOR'S PROJECT SUPERVISOR MUST HAVE A MINIMUM OF FIVE (5) YEARS EXPERIENCE PERFORMING GEOTHERMAL SYSTEM INSTALLATIONS.
- C.A. THE GEOTHERMAL CONTRACTOR OR SUB-CONTRACTED GEOTHERMAL DRILLER MUST HAVE CURRENT NYSDEC DRILLERS LICENSES TO PERFORM THE WORK SPECIFIED.
- D. **CONTRACTOR WARRANTY:** THE CONTRACTOR SHALL WARRANTY HIS WORK TO BE FREE OF DEFECTS FOR A PERIOD OF 5 YEARS FROM THE DATE OF COMPLETION. THE HDPE LOOP PIPING SHALL HAVE A 50-YEAR WARRANTY. THE HORIZONTAL PIPING SHALL HAVE A 25 YEAR WARRANTY.
- E. **SUBMITTALS:** THE CONTRACTOR MUST PROVIDE THE FOLLOWING SUBMITTALS FOR APPROVAL:
- E.A. HDPE PIPING AND FITTINGS
  - E.B. HEAT TRANSFER FLUID
  - E.C. GROUT MATERIAL AND MIX DESIGN
  - E.D. PROOF OF IGSHPA AI CERTIFICATIONS
  - E.E. GEOTHERMAL HEAT PUMP
  - E.F. GEOTHERMAL PUMP (FLOW CENTER)
  - E.G. PIPING ACCESSORIES
- F. **CLOSEOUT DOCUMENTS:** AT THE CONCLUSION OF THE WORK THE CONTRACTOR SHALL PROVIDE REPRODUCIBLE AS-BUILT DRAWINGS OF THE EXTERIOR LOOP INSTALLATION WITH DRILLING LOGS OF THE DRILLED CLOSED LOOP BOREHOLES. THE AS-BUILTS SHALL HAVE THE DEPTH OF THE BOREHOLES, DRILLING LOGS, GROUT INFORMATION, LOCATION OF BOREHOLES AND PIPING MEASURED FROM FIXED LOCATIONS ON THE SITE.
- F.A. THE CONTRACTOR SHALL PROVIDE AN O&M BINDER CONTAINING ALL EQUIPMENT CUT SHEETS, O&M MANUALS, WARRANTY'S, AS-BUILT DRAWINGS AND SERVICE CONTACT INFORMATION.
- G. **INSPECTION REQUIREMENTS:** THE CONTRACTOR WILL ALLOW FOR ANY REQUIRED TOWN AND OR OWNER RELATED INSPECTIONS OF THE DRILLING, PIPING INSTALLATION, FLUSHING, PURGING, PRESSURE TESTING AND START-UP OF ANY OF THE INSTALLED WORK.
- G.A. INSTALLATION OF THE INTERIOR COMPONENTS; GEOTHERMAL HEAT PUMP, FLOW CENTER, AND ALL PIPING AND ELECTRICAL SHALL BE DONE IN CONFORMANCE WITH ALL TOWN OF BROOKHAVEN CODES, NEW YORK STATE BUILDING CODES AND NATIONAL ELECTRIC CODES. INTERIOR PIPING SHALL BE INSULATED AS PER THE MECHANICAL DRAWING "M-DRAWING" REQUIREMENTS.

## GEOTHERMAL SPECIFICATIONS (CONT'D)

### PART II: PRODUCTS

- A. **POLYETHYLENE (HDPE) PIPE AND FITTINGS** - THE MATERIAL SHALL MAINTAIN A 1600 PSI HYDROSTATIC DESIGN BASIS AT 73.4 DEGREES FAHRENHEIT PER ASTM D2837, AND SHALL BE LISTED IN PPI TR4 AS A PE4710 PIPING FORMULATION. THE MATERIAL SHALL BE A HIGH DENSITY, POLYETHYLENE EXTRUSION COMPOUND HAVING A CELL CLASSIFICATION OF PE445574C WITH A UV STABILIZER OF C AS SPECIFIED IN ASTM D3350. THIS MATERIAL SHALL EXHIBIT ZERO FAILURES (FO) WHEN TESTED FOR 500 HOURS UNDER ASTM F1473 AS REQUIRED IN ASTM D3350. FITTINGS SHALL BE COMPATIBLE WITH THE PIPE MATERIAL OR FROM THE SAME MATERIAL AS THE PIPES.
- A.A. MARKINGS: PIPE SHALL BE MARKED WITH MANUFACTURER'S NAME AND PRODUCT NAME, NOMINAL SIZE, ASTM DIMENSIONAL STANDARD, PPI MATERIAL CLASSIFICATION, CELL CLASSIFICATION, SEQUENTIAL FOOTAGE, AND MANUFACTURER'S DATE CODE.
- A.B. ALL PIPING SHALL BE SDR-11 HDPE PIPING. FITTINGS SHALL BE COMPATIBLE WITH THE PIPE MATERIAL OR FROM THE SAME MATERIAL AS THE PIPES. SOCKET FITTINGS SHALL CONFORM TO ASTM D2513 & ASTM D2683. BUTT FITTINGS SHALL CONFORM TO ASTM D3261. SADDLE FITTINGS SHALL CONFORM TO ASTM D3261 OR ASTM D2513 & ASTM D2683. ELECTRO-FUSION FITTINGS SHALL CONFORM TO ASTM F1055.
- A.C. THE ONLY ACCEPTABLE METHOD FOR JOINING BURIED PIPE SYSTEMS IS BY A HEAT FUSION PROCESS. POLYETHYLENE PIPE SHALL BE BUTT OR SOCKET FUSED IN ACCORD WITH PIPE MANUFACTURER'S PROCEDURES. ELECTROFUSION IS ACCEPTABLE WITH ENGINEER'S APPROVAL. TUBING SHALL BE FREE FROM DEFECTS IN MATERIAL AND WORKMANSHIP.
- B. **GEOTHERMAL BOREHOLE GROUT** - ENGINEERED LOW PERMEABILITY HIGH THERMAL CONDUCTIVE GROUT, TG SELECT, POWER TEC, BY GEOPRO INC., OR APPROVED EQUAL.
- B.A. GROUT SHALL MEET THE FOLLOWING PHYSICAL CHARACTERISTICS:
- B.B. THERMAL CONDUCTIVITY: 1.0 BTU/HR-FT.-F
  - B.C. PERMEABILITY: < 1.0 X 10<sup>-7</sup>
  - B.D. WATER - THE MIXING WATER SHALL BE POTABLE. WATER WITH EXCESSIVE IMPURITIES MAY AFFECT THE FINAL PROPERTIES OF THE GROUT AND SHALL NOT BE USED.
  - B.E. HEAT TRANSFER FLUID - THE GEOTHERMAL HEAT TRANSFER FLUID SHALL BE WATER AND 20% PROPYLENE GLYCOL THE PH OF WATER SHALL BE BETWEEN 6 AND 7. THE HEAT TRANSFER FLUID SHALL BE DOWFROST GEO20 BY DOW CHEMICAL.
- C. **FOUNDATION PENETRATION SEAL** - THE PENETRATIONS INTO THE HOUSE WILL BE CORE DRILLED. THE 2" SDR-11 HDPE PIPE REQUIRES LINK-SEAL MODULAR SEALS FOR EACH PIPE INSTALLED AS PER THE MANUFACTURERS INSTRUCTIONS.
- D. SEE THE GEOTHERMAL EQUIPMENT SCHEDULE ON SHEET GT-101 FOR GEOTHERMAL HEAT PUMP AND FLOW CENTER EQUIPMENT SELECTION. INSTALL ALL MECHANICAL AND ELECTRICAL EQUIPMENT AS PER MANUFACTURES AND APPLICABLE CODE REQUIREMENTS.

## GEOTHERMAL SPECIFICATIONS (CONT'D)

### PART III: EXECUTION

- A. **PROTECTION OF EXISTING UTILITY STRUCTURES:** PROTECT THE EXISTING UTILITIES SHOWN ON ALL DISCIPLINES OF THE DRAWINGS, AS LOCATED FROM UTILITY MARKOUTS, OR NOT IN THE LOCATIONS OF WHICH ARE KNOWN OR UNKNOWN PRIOR TO EXCAVATION, FROM DAMAGE DURING EXCAVATION AND BACKFILLING OF TRENCHES AND, IF DAMAGED, REPAIR ALL DAMAGE AT NO EXPENSE TO THE OWNER. NOTIFY CONSTRUCTION MANAGER OF ANY EXISTING LINE OR UTILITY STRUCTURE THAT IS NOT SHOWN ON THE DRAWINGS.
- B. **TRENCH EXCAVATION:** EXCAVATE TRUE TO LINE AND PROVIDE A CLEAR SPACE ON EITHER SIDE OF THE PIPE TO FACILITATE BEDDING. HEAT EXCHANGER HORIZONTAL PIPING SHALL BE PROVIDED WITH A MINIMUM COVER OF FOUR (4) FEET TO FINAL GRADE.
- C. **UNSUITABLE MATERIAL:** WHERE THE BOTTOM OF THE TRENCH IS FOUND TO BE UNSTABLE OR TO INCLUDE ASHES, CINDERS, ALL TYPES OF REFUSE, VEGETABLE OR OTHER ORGANIC MATERIAL, OR LARGE PIECES OF FRAGMENTS OF INORGANIC MATERIAL, WHICH IN THE JUDGMENT OF THE ENGINEER SHOULD BE REMOVED, EXCAVATE AND REMOVE SUCH UNSUITABLE MATERIAL TO A MINIMUM DEPTH OF 6 INCHES BELOW THE PIPE.
- D. **BACKFILL:** BACKFILL THE TRENCH WITH SELECT BEDDING MATERIAL AND COMPACT TO PROVIDE UNIFORM AND CONTINUOUS BEARING FOR THE PIPE. DISPOSE OF THE UNSUITABLE MATERIAL. PROTECT EXCAVATION BOTTOMS AGAINST FREEZING WHEN ATMOSPHERIC TEMPERATURE IS LESS THAN 35°F.
- E. **EXCAVATION:** EXCAVATION WORK SHALL BE PERFORMED BY QUALIFIED CONTRACTORS.
- F. **PIPING INSTALLATION:** PIPE SHALL BE INSTALLED IN ACCORDANCE WITH RECOMMENDATIONS OF ASHRAE AND IGSHPA. PIPE JOINTS SHALL BE HEAT FUSION TYPE AND SHALL BE MADE AS RECOMMENDED BY THE PIPE MANUFACTURER.
- F.A. OPEN ENDS OF ALL PIPE SHALL BE SEALED AT ALL TIMES TO PREVENT ENTRY OF CONTAMINANTS UNTIL FINAL CONNECTIONS ARE MADE.
- F.B. ALL FINAL TESTS PERFORMED ON THE COMPLETED LOOP FIELD SHALL BE WITNESSED BY THE ENGINEER. PROVIDE MINIMUM OF 2 WORKING DAYS ADVANCE NOTICE TO THE ENGINEER PRIOR TO TESTING. PRESSURE TESTING OF PIPE SHALL BE DONE AS PER SECTION I BELOW.
- G. **GROUTING WELL**
- G.A. BOREHOLES IN VERTICAL HEAT EXCHANGERS SHALL BE TREMI-GROUTED. GROUTING OF VERTICAL HEAT EXCHANGERS SHALL BE DONE IN ACCORDANCE WITH THE LATEST STATE JURISDICTIONAL REQUIREMENTS AND IGSHPA STANDARDS. GROUTING SHALL IMMEDIATELY FOLLOW THE COMPLETION OF DRILLING AND INSTALLATION OF EACH HEAT EXCHANGER. A LARGE CAPACITY GROUT MIXER / SEPARATE HOLDING TANK ARE REQUIRED AND A MINIMUM OF 1" DIAMETER POLYETHYLENE TUBING SHALL BE USED AS THE TREMI-GROUT PIPE. THE TREMI-GROUT PIPE SHALL BE ATTACHED TO THE U-BEND HEAT EXCHANGER BEFORE IT IS LOWERED INTO THE GROUND
- G.B. GROUTING PROCEDURES TO BE FOLLOWED:
- G.B.A. MONITOR THE GROUTING OPERATION TO ENSURE GROUT IS BEING ADEQUATELY MIXED IN CORRECT PROPORTIONS AND THAT THE VISCOSITY IS ADEQUATE FOR PUMPING DOWN THE BOREHOLE
  - G.B.B. A SCREW-TYPE PUMP OR A PISTON PUMP SHALL BE USED TO PUMP GROUTS DOWN THE BOREHOLE.
  - G.B.C. DETECTABLE WARNING TAPE SHALL BE OF THE TYPE SPECIFICALLY MANUFACTURED FOR MARKING AND LOCATING UNDERGROUND GEOTHERMAL PIPING. THE TAPE SHALL BE INSTALLED AT A DEPTH OF 24 INCHES BELOW FINISHED GRADE UNLESS OTHERWISE SHOWN. TAPE SHALL HAVE INTEGRAL WIRES, FOIL BACKING, OR OTHER MEANS TO ENABLE DETECTION BY A METAL DETECTOR WHEN THE TAPE IS BURIED UP TO 3 FEET DEEP.
- H. **FLUSHING AND PURGING:**
- H.A. CONFIGURE FLUSHING/PURGING UNIT AS RECOMMENDED BY IGSHPA. FLUSH LINES AND APPURTENANCES AS REQUIRED FOR REMOVING ALL DIRT AND CONTAMINANTS WITHIN THE PIPING SYSTEM WITH POTABLE WATER UNTIL NO DIRTY WATER APPEARS AT OUTLET.
- H.B. PURGE AIR FROM SYSTEM, OR SECTIONS OF SYSTEM, BY MAINTAINING MINIMUM VELOCITY OF 4 FEET PER SECOND THROUGH ALL PIPES. PURGE UNTIL NO AIR BUBBLES ARE OBSERVED LEAVING THE SYSTEM. FLUSH AND PURGE IN BOTH DIRECTIONS. MINIMUM FLOW TO BE 1 HOUR IN EACH DIRECTION FOR EACH CIRCUIT. NOTIFY ENGINEER MINIMUM 2 DAYS BEFORE FLUSHING OPERATION.
- H.C. FLUSHING EQUIPMENT MUST INCLUDE; FLOW METER, PRESSURE GAUGE AND THE PUMP CURVE FOR THE FLUSHING PUMP.
- I. **PRESSURE TESTING:** PRESSURE TESTING SHALL BE DONE IN ACCORDANCE WITH NYS BUILDING CODE AND IGSHPA SPECIFICATIONS FOR GEOTHERMAL PIPING SYSTEMS.
- I.A. MAINTAIN HYDROSTATIC PRESSURE OF 100 PSI (+/-5PSI) FOR 1 HOURS.
- I.B. IF PRESSURE DROPS BY MORE THAN 5 PSI AT THE END OF 1 HOUR, TEST IS DEEMED A FAILURE AND CORRECTIVE ACTION MUST BE TAKEN TO LOCATE AND REPAIR LEAK.

General Notes

CONSULTANTS:



UNAUTHORIZED ADDITION OR ALTERATION OF THIS DRAWING OR RELATED DOCUMENTS IS A VIOLATION OF SECTION 7209 OF THE NEW YORK STATE EDUCATION LAW

R2	FOR BUILDING DEPT	02/02/18
R1	FOR APPROVAL	12/26/17
No.	Revision/Issue	Date

Firm Name and Address  
**RENU Engineering Technologies, PC**  
 15 RIVER ROAD, SUITE 15B  
 WILTON, CT 06897  
 203.664.1312  
 info@RENUet.com

Project Name and Address  
**UNITED WAY GEOTHERMAL SYSTEM**  
 6 HAWKINS AVENUE, MEDFORD NY

Project <b>ZBF-1703</b>	Sheet <b>GT-102</b>
Date <b>12-01-17</b>	
Scale	

Appendix D  
Glenwood Village EM&V Report

# Field Monitoring of a Community Ground Source Heat Pump System in Riverhead

Prepared for:

**New York State Energy Research and Development Authority**

Albany, NY

Scott Smith

Program Manager, Clean Heating and Cooling

and

**National Grid**

Brooklyn, NY

Chong Lin

Project Manager

Prepared by:

**Frontier Energy Inc**

Cazenovia NY

Carina Paton and Chris Doty

and

**Owahgena Consulting Inc**

Cazenovia NY

Hugh I. Henderson, Jr., P.E.



## Notice

---

This report was prepared by Frontier Energy Inc. and Owahgena Consulting Inc. in the course of performing work contracted for and sponsored by National Grid and the New York State Energy Research and Development Authority (hereafter “NYSERDA”). The opinions expressed in this report do not necessarily reflect those of National Grid, NYSERDA or the State of New York, and reference to any specific product, service, process, or method does not constitute an implied or expressed recommendation or endorsement of it. Further, National Grid, NYSERDA, the State of New York, and the contractor make no warranties or representations, expressed or implied, as to the fitness for particular purpose or merchantability of any product, apparatus, or service, or the usefulness, completeness, or accuracy of any processes, methods, or other information contained, described, disclosed, or referred to in this report. National Grid, NYSERDA, the State of New York, and the contractor make no representation that the use of any product, apparatus, process, method, or other information will not infringe privately owned rights and will assume no liability for any loss, injury, or damage resulting from, or occurring in connection with, the use of information contained, described, disclosed, or referred to in this report.

NYSERDA makes every effort to provide accurate information about copyright owners and related matters in the reports we publish. Contractors are responsible for determining and satisfying copyright or other use restrictions regarding the content of reports that they write, in compliance with NYSERDA’s policies and federal law. If you are the copyright owner and believe a NYSERDA report has not properly attributed your work to you or has used it without permission, please email [print@nyserda.ny.gov](mailto:print@nyserda.ny.gov)

Information contained in this document, such as web page addresses, are current at the time of publication.

## Preferred Citation

---

New York State Energy Research and Development Authority (NYSERDA). 2020. “Field Monitoring of a Community Ground Source Heat Pump System in Riverhead” NYSERDA Report Number xx-xx.

Prepared by Frontier Energy Inc., Cazenovia, NY. [nyserda.ny.gov/publications](http://nyserda.ny.gov/publications).

## Abstract

---

A ground source heat pump system was installed in Riverhead, NY with ten heat pumps in single family homes connected to common ground loop. The homes were originally heated with propane or kerosene. A data collection system was installed to quantify performance of the individual heat pumps as well as the overall performance of the common ground loop. The measured data showed an average seasonal heating COP of 2.83, which was lower than the AHRI-rated COPs. Efficiencies were lower than expected due to: 1) the use of lower efficiency “split” heat pumps that were installed due to space constraints, 2) higher than expected fan and pumping power, 3) the combination of a dual-stage heat pump with constant speed pumping. Overall, the range of ground loop temperature were modest compared to design expectations. Overall annual (heating and cooling) cost savings for the homeowners ranged from \$341 to \$1037 (31% to 60%, an average of 43%).

## Keywords

---

Ground source heat pumps, common ground loops

## Acknowledgments

---

The authors wish to acknowledge Chong Lin at National Grid for his guidance and efforts to enable the field monitoring in these homes, and thanks to the homeowners for allowing us to complete the monitoring installation and for their helpful survey responses. Also, thanks to Dave Reardon and his staff at Miller Environmental as well as PGI Corp for coordinating with our monitoring installation efforts and for allowing us to pre-install sensors on equipment in their shop. Finally, thanks to Scott Smith at NYSERDA for his technical guidance on this field test effort.

# Table of Contents

---

Notice .....	ii
Preferred Citation.....	ii
Abstract.....	iii
Keywords .....	iii
Acknowledgments.....	iii
List of Figures.....	vi
List of Tables .....	vii
Acronyms and Abbreviations.....	viii
Summary.....	1
<b>1 Introduction .....</b>	<b>1</b>
1.1 Background.....	1
1.2 Goals .....	1
<b>2 Site and System Description.....</b>	<b>2</b>
2.1 Baseline Conditions in Homes .....	2
2.2 Weatherization Improvements.....	4
2.3 Description of Ground Loop and Heat Pumps .....	5
<b>3 Monitoring Approach.....</b>	<b>11</b>
3.1 Monitored Data Points and Data Collection.....	11
3.2 One-Time Readings and Sensor Verification.....	13
3.3 Calculated Quantities .....	14
3.3.1 Heating Performance.....	14
3.3.2 Cooling Performance .....	14
3.4 Monitoring Period Timeline.....	15
<b>4 Results and Analysis.....</b>	<b>16</b>
4.1 Summary of Energy Use and Operating Patterns .....	16
4.2 Explaining Differences in Heat Pump Performance.....	28
4.2.1 Comparing High- and Low-Stage Heat Pump COP.....	28
4.2.2 Examining Peak Hour Heat Pump Performance.....	31
4.2.3 Differences in Dual Stage Fan Control.....	35
4.2.4 Summary of Observed Performance Differences .....	37
4.3 Ground Loop Temperatures .....	38
4.4 Ground Loop Load Diversity .....	40

4.5	Impact of Reversed Loop Piping .....	42
4.5.5	Test to Show the Impact of Backwards Flow on HP2 .....	48
4.6	Estimated Cost Savings .....	53
<b>5</b>	<b>Homeowner Survey Results .....</b>	<b>56</b>
5.1	Motivations for Participation .....	56
5.2	Overall Satisfaction.....	57
5.2.1	Perceived Heating Performance .....	58
5.2.2	Perceived Cooling Performance .....	59
5.3	Operating Costs .....	60
5.3.3	Perceived Heating Costs.....	60
5.3.4	Perceived Cooling Costs.....	61
5.4	The Heat Pump Installation Process.....	62
5.5	Highlights from Phone Interviews .....	62
<b>6</b>	<b>Summary and Conclusions .....</b>	<b>65</b>
6.1	Overall Heat Pump Performance .....	65
6.2	Ground Loop Performance .....	66
6.3	Cost Savings .....	66
6.4	Survey Results.....	67
6.5	Conclusions and Lessons .....	67
<b>Appendix A: Analysis of Fuel Bills from Existing Homes.....</b>		<b>1</b>
<b>Appendix B: Comparing Measured Heating Load Data to Manual J Peak Loads .....</b>		<b>1</b>
<b>Appendix C: Comparing Measured HP Performance to Manufacturers Data.....</b>		<b>1</b>
C.1	Steady State HP Performance.....	1
C.1	Theoretical Impact of One Stage Pumping .....	3
<b>Appendix D: Variations in Pump and Fan Operation and Fan-Compressor Operating Patterns .....</b>		<b>1</b>
D.1	Trend of Loop Flow, Pump Power and Fan Power .....	1
D.2	Operating Patterns for Compressor and Fan Power .....	1

# List of Figures

---

Figure 1. Photo of Typical House Installed on Ground Loop.....	2
Figure 2. Outdoor Section of “Split” GSHP Unit (RT series) .....	6
Figure 3. Flow Center installed on Side of Outdoor Unit (with Onicon BTU Meter Shown).....	7
Figure 4. Layout of Ground Heat Exchanger and Homes on Common Loop.....	8
Figure 5. Ground Loop Design Details (from GSHP Design Report; loop sized based on heating loads) ..	9
Figure 6. Schematic of Common Loop Piping with Individual Pumping for Each Heat Pump .....	10
Figure 7. Schematic of a Heat Pump System with Measured Data Points Shown.....	11
Figure 8. Compressor Power vs. Runtime to Show Low- and High-Stage Operation: HP1 & HP3 .....	29
Figure 9. Heating COP vs Heating Output for HP1 & HP3 .....	30
Figure 10. A few Hour of Operation When HP7 goes into High Stage .....	31
Figure 11. Comparing Heating COP to Pumping Power for all HP Systems .....	33
Figure 12. Comparing Heating COP to Fan Power for all HP systems.....	34
Figure 13. Comparing Hourly Fan Power to Compressor Power for HP1 & HP3 .....	36
Figure 14. Loop Supply (TWS) and Return (TWR) Temperatures (thick lines are Main Loop).....	39
Figure 15. Plot of Hourly Loads Imposed on the Ground Loop.....	40
Figure 16. Comparing Main Loop TWS & TWR (lines) to HP TWS (green) and TWR (red) – HPs 1 to 4 .....	42
Figure 17. Comparing Main Loop TWS & TWR (lines) to HP TWS (green) and TWR (red) – HPs 5 to 10.....	43
Figure 18. Photos Showing Header Details from Ground Loop Heat Exchanger to Each HP .....	44
Figure 19. Example of How Piping Could be Switched at the Heat Pump.....	45
Figure 20. Comparing Sum of Heat Pump Flows to the Main Loop Flow (red data is when all 10 HPs are ON).....	46
Figure 21. Comparing Sum of BTU Meter Heat Rates to the Main Loop Heat Rates (red data is when all 10 HPs are ON) .....	47
Figure 22 Flow Data for September 6 When Flow was Shutoff.....	48
Figure 23 Loop Temperature Data for September 6 When Flow was Shutoff – HP1 to HP4.....	49
Figure 24 Loop Temperature Data for September 6 When Flow was Shutoff – HP5 to HP10.....	50
Figure 25 Supply Header Circuiting Details Showing HP 6 through HP10 are Downstream of HP2 .....	51
Figure 26 Schematic Showing Impact of Reversed Piping for HP2.....	52
Figure 27 Plot Showing When Piping change was Made for HP2 on November 6, 2018.....	52
Figure 28 Survey Results on Homeowner Motivations to Participate in the GSHP Pilot .....	56
Figure 29 Survey Results on Overall Homeowner Satisfaction with the GSHP System.....	57
Figure 30 Survey Results on Perception of Heating Performance Before and After Upgrade.....	58
Figure 31 Survey Results on Perception of Cooling Performance Before and After Upgrade.....	59
Figure 32 Survey Results on Perception of Heating Costs Before and After Upgrade .....	60
Figure 33 Survey Results on Perception of Cooling Costs Before and After Upgrade .....	61
Figure 34 Survey Results on GSHP Installation Process .....	62

# List of Tables

---

Table 1. Ten Houses Installed on Geothermal System .....	3
Table 2. Air Tightness Improvements from Weatherization .....	4
Table 3. Rated Performance Data for Hydron GSHP Units .....	5
Table 4. Heat Pump Model Installed in Each House .....	5
Table 5. Measured Data Points for each Heat Pump Unit.....	12
Table 6. Measured Data Points for the Common Ground Loop.....	12
Table 7. Milestones and Events Across the Monitoring Period .....	15
Table 8. Annual Energy Use, Loads and Efficiencies for All Units for July 2018 thru June 2019.....	17
Table 9. Monthly Energy Use, Loads and Efficiencies for HP Unit 1 .....	18
Table 10. Monthly Energy Use, Loads and Efficiencies for HP Unit 2 .....	19
Table 11. Monthly Energy Use, Loads and Efficiencies for HP Unit 3 .....	20
Table 12. Monthly Energy Use, Loads and Efficiencies for HP Unit 4 .....	21
Table 13. Monthly Energy Use, Loads and Efficiencies for HP Unit 5 .....	22
Table 14. Monthly Energy Use, Loads and Efficiencies for HP Unit 6 .....	23
Table 15. Monthly Energy Use, Loads and Efficiencies for HP Unit 7 .....	24
Table 16. Monthly Energy Use, Loads and Efficiencies for HP Unit 8 .....	25
Table 17. Monthly Energy Use, Loads and Efficiencies for HP Unit 9 .....	26
Table 18. Monthly Energy Use, Loads and Efficiencies for HP Unit 10 .....	27
Table 19. Measured Performance at a Peak Hour of Heating Operation .....	32
Table 20. Pump Performance Metrics at Peak Heating Hour .....	32
Table 21. Fan Performance Metrics at Peak Heating Hour .....	33
Table 22. Fan Power Difference Between Low-Stage and High-Stage Operation .....	35
Table 23. Summary of Observed Differences Between GSHP Systems .....	37
Table 24. Comparing Non-coincident HP Loop Loads to Total Loop Loads .....	41
Table 25. Summary of Annual Measured Load, Efficiency and Energy Use Data for Each Home.....	53
Table 26. Summary of Annual Cost Savings from Heating for each Home .....	54
Table 27. Summary of Annual Cost Savings from Cooling for each Home.....	54
Table 28. Summary of Annual Greenhouse Gas Reductions.....	55



## Acronyms and Abbreviations

---

ACH <sub>50</sub>	air change rate (per hour) for a building when pressurized to 50 Pascals
AHRI	Air Conditioning, Heating and Refrigeration institute (trade association)
ASHRAE	American Society of Heating Refrigerating and Air-Conditioning Engineers
COP	coefficient of performance (or heating efficiency)
CT	current transducer (or transformer)
DX	direct expansion (evaporator coil or refrigeration system)
cfm	cubic feet per minute (of airflow)
°F	degree Fahrenheit
EER	energy efficiency ratio (or cooling efficiency)
gpm	gallons per minute
GHG	greenhouse gas (usually expressed as CO <sub>2</sub> equivalent)
GLHP	ground loop heat pump (designation for rating condition in ISO Std)
GSHP	ground source heat pump
HP	heat pump
HVAC	Heating Ventilation and Air Conditioning
ISO	International Standards Organization
kW	kilowatts
kWh	kilowatt hours
LIPA	Long Island Power Authority
MBtu	thousand Btu
MMBtu	million BTU
NYS	New York State
NYSERDA	New York State Energy Research and Development Authority
SS	steady state
W	watts

# Summary

---

This pilot project installed and monitored a community loop ground source heat pump system that served ten single family homes in a housing development in Riverhead, NY. Each home had a 3-ton ground source heat pump installed to replace a fuel-fired furnace (either propane or kerosene). Some houses also originally had central air conditioning. Many of the homes were weatherized as part of heat pump installation to reduce heating and cooling loads and improve homeowner comfort. The new heat pumps were tied into a central ground loop heat exchanger that was installed in the common area between the homes. Two homes used conventional “packaged” ground source heat pumps. Due to space limitations the remaining eight homes used “split” units with separate indoor and outdoor sections. The “split” units were lower efficiency systems.

## S.1 Monitoring Approach

A data acquisition system was installed with BTU meters to measure the performance of the ground loop and the detailed performance of each heat pump unit. BTU and power meters were installed on each heat pump to quantify its thermal output and efficiency in both heating and cooling modes. Additional sensors included power and runtime of key components (pumps, fans resistance elements) as well as air temperature to understand space conditions and diagnose performance issues. A central data logger communicated wirelessly to collect data from each heat pump unit at 5-minute intervals.

## S.2 Monitoring Results

Monitoring began in December 2017 and continued through December 2019. Due to home construction delays and monitoring system issues, full data collection was not established until June 2018.

**Heating Efficiency.** The average seasonal heating COP was 2.83 for the ten HP units, lower than the AHRI-rated COPs. The seasonal average COP for the different heat pump units ranged from 2.20 to 3.71. Some of the reasons for the measured differences in heating efficiency were:

- The packaged units had an average COP of 3.6. The measured COPs for split systems ranged from 2.2 to 3.0 and averaged 2.63.
- The fan power associated with the units in each home ranged from 232 to 466 Watts, due to differences in the ductwork and airflows. A trend of higher COP with lower fan power was observed.
- Pump power ranged from 165 to 407 Watts as the loop flow varied from 6 to 11 gpm. The trend of higher COP with lower pump power was observed.

- Three heat pump units did not vary airflow with high- and low-stage compressor operation. This resulted in excess fan power for low-stage operation, which lowered seasonal COP.
- The system was designed with a dual-stage heat pump combined with constant speed loop pumping. This design choice resulted in a lower COP for low-stage operation. Since units were generally oversized, the units all spent most of their operating time at low stage. The low-stage COP was generally 5-15% lower than high-stage operation, which lowered the seasonal COP.

**Ground Loop Performance.** The measured supply temperatures from ground loop stayed well within the stated design targets of 37°F minimum in heating and 80°F maximum for cooling. Since the heat pumps were generally oversized, the load on the ground loop resulted in supply temperatures that rarely dropped below 45°F in the winter or rarely exceeded 70°F in the summer. By measuring heat transfer rates for the main ground loop and the individual heat pumps, we were able to observe 80% coincidence for peak loads from the ten heat pumps on this common loop system.

One loop installation problem we found was that the piping from the ground loop to HP2 was hooked up backwards. This caused the entering temperatures for HP2 to be at the return conditions: i.e., warmer in the summer and colder in the winter. This pumping mistake also negatively impacted the entering water temperatures for at least four additional heat pumps.

This mistake of switching pipes occurred because the system used a common loop with individual pumps on each heat pump. This design creates a new installation issue that is not normally considered by loop installers in traditional installations. This project underwent a very thorough commissioning process by a highly qualified third-party ground loop inspector that was still not able to detect the problem. It was only found and fixed after the fact using detailed monitored data in the summer months.

**Cost Savings and Economics.** The cost savings for each home were determined using assumed electric costs for LIPA and delivered fuel costs. Heating savings ranged from \$306 to \$886 per year (33% to 67%, average of 48%). The site with propane had the largest savings. Cooling savings ranged from \$9 to \$160 per year (5% to 40%, average of 25%). Total annual savings range from \$341 to \$1037 per year (31% to 60%, average of 43%). Annual savings for all ten sites was \$6,562. The system cost of \$301,570 results in a simple payback of 46 years.

### **S.3 Survey Results**

We conducted on-line surveys of the homeowners when the heat pumps were first installed and then after a year of operation. At most sites, we followed with phone interviews. The survey and interview results show that homeowners who participated in this pilot project were primarily motivated to accept a new

system by: 1) having a better cooling system, 2) reducing heating energy bills and 3) eliminating the hassle and safety/health issues of delivered fossil fuels.

Homeowners were generally satisfied with the performance of the new cooling system and operating costs of their cooling system, though some did perceive higher than expected costs. For heating, their perception of operating costs were below expectations for slightly more than half of the respondents – even though we demonstrated that all the homes had heating cost savings based on measured data. One issue driving expectations could be the fact that homeowners might tend to “forget” the fuel bill they no longer pay but clearly “remember” the larger electric bill that continues to come each month. This may skew their perception of any net savings between the two bills.

Some homeowners reported problems understanding and using the new electronic thermostats installed as part of the project. This was corroborated by the measured data where several homes seemed to have cooling set points that were unexpectedly low (70°F, 66°F, etc.). We also observed some heat set points in the low 60s. Problems with maintaining desired temperatures and controlling set back seemed to have been an issue for some homeowners.

## **S.4 Lessons from this Study**

As a result of this study, we make the following observations and lessons for future applications of community ground source heat pump systems as well as for GSHP systems in general.

**GSHP Retrofits are Difficult in Some Existing Homes.** The single-family homes in this project were all originally heated by fuel-fired furnaces. The furnace closets in these manufactured homes were space constrained so that less-efficient, split-system GSHP units had to be installed in eight of the homes. In addition, the existing furnace ductwork in some homes was undersized relative to the higher airflows required by the heat pump units. The result was higher installation costs, lower heat pump efficiency, and greater fan power than might be expected in more ideal applications.

### **Common Loops Have Benefits and Drawbacks.**

- **Leveraging Load Diversity.** Installing multiple heat pumps on a common ground loop has potential benefits of improved load diversity. At this site we measured 80% coincidence of peak loads (where 100% equates to perfect coincidence or no diversity). Load diversity (or lack of coincidence) can result in better overall performance than dedicated loops installed to serve each heat pump with the same number of vertical bores. Load diversity is highest with mixed

applications, such as combining retail and residential, and lowest when the loads are the same, such as a group of single-family homes.

- **Loop Pumping.** Common loops with centralized variable speed loop pumping offer significant pumping savings at part load – which is one of the largest benefits of a common ground loop. Common loops with individual pumping offer smaller pumping savings, since the Watts per actual gpm remain constant as part load. In general, we estimate centralized variable speed pumping might reduce annual pumping energy by a factor of two compared to individual pumping.
- **Construction Costs.** The cost of constructing a common loop with individual pumping (as used in this study) was greater than the cost of installing multiple individual ground loops for each heat pump as one construction project. If designers can take advantage of the load diversity in common loops by installing a smaller ground heat exchanger to reduce cost and also reap the operating benefits of centralized variable speed pumping, then the cost and performance benefits of common loops may be greater than the drawbacks.

**Modulating Heat Pumps Require Modulating Flows.** Heat pumps that are dual-stage or variable-speed should also be able to vary loop flow and airflow to achieve the best performance. The dual stage heat pumps in this study were designed with constant speed pumping. As a result, the low-stage COP was about 10-15% lower than the high-stage COP – negating the expected seasonal efficiency benefit of the dual stage unit. In addition, the airflow on three heat pumps did not vary with heat pump capacity as expected (presumably due to an improper unit setting). Care must be taken during installation, setup and commissioning to ensure modulating flow is achieved. For GSHP units in this project, using a single stage thermostat with only the unit’s high-stage would have improved seasonal system efficiency.

**Higher System Efficiency at Modest Flows.** The published data for the heat pump unit alone show that unit efficiency is higher at higher airflows and loop flows. However, the efficiency of the heat pump system, including pumps and fans, usually decreases at higher flows. Meeting or exceeding common rule-of-thumb targets for loop flows and airflows usually result in lower overall system COPs. In terms of airflow, HVAC systems often have optimal efficiency at flow rates from 350-375 cfm per installed ton –this is especially true in retrofits with constrained ductwork. Similarly, loop flowrates should be selected to ensure reliable operation at all operating conditions. The most efficient loop flow rate is usually lower than 3 gpm per installed ton.

# 1 Introduction

---

## 1.1 Background

At the direction of the Public Service Commission, National Grid undertook a field demonstration of geothermal heat pump systems in several homes combined on a community loop in Riverhead on Long Island. The pilot project combined 10 residential heat pumps onto a centralized ground loop heat exchanger. The goal is to understand the costs and performance of shared geothermal resources in residential applications. This “Non-Pipes” alternative project was implemented in a single-family housing development near Riverhead, NY where natural gas was not available.

NYSERDA is also evaluating the performance of 36 ground source or geothermal heat pump systems as part of the validation project on Long Island<sup>1</sup>. The NYSERDA project will collect detailed performance data and will also survey the homeowners to understand their perceptions of the GHP system (relative to their original system) in terms of comfort, quality, efficiency, and costs.

National Grid and NYSERDA integrated and harmonized these two projects to include a larger sample of heat pump systems. The survey approach was similar between the projects, though the monitoring approach was slightly different.

## 1.2 Goals

National Grid and NYSERDA undertook this demonstration project to understand the potential benefits of a ground source heat pump system that serves multiple homes using a community or common ground loop. The project seeks to understand the detailed performance and resulting efficiency of ground source heat pumps in general. It also seeks to understand the benefits of combining multiple heat pumps onto a larger ground loop.

---

<sup>1</sup> A similar project was completed in 2017 in Upstate New York using data the from 50 WaterFurnace heat pump units with the Symphony monitoring system (NYSERDA Report 18-03)



## 2 Site and System Description

---

### 2.1 Baseline Conditions in Homes

Ten homes in the Glenwood Village development in Riverhead, NY were included in this ground source heat pump (GSHP) pilot project. These homes are manufactured houses with crawl spaces ranging from 900 to 1,600 square feet, as shown in Table 1. The oldest home was built in 1975. Two of the homes were newly installed (in 2017) during this project with new GSHP units. The other eight existing homes were retrofitted with GSHPs. The original heating system was either a kerosene or propane furnace.

**Figure 1. Photo of Typical House Installed on Ground Loop**



**Table 1. Ten Houses Installed on Geothermal System**

<b>HP Unit No</b>	<b>House</b>	<b>Year Built</b>	<b>Floor Area (sq ft)</b>	<b>Bed rooms</b>	<b>Original Heating System</b>	<b>Original Cooling System</b>	<b>Manual J Heating Load (MBtu/h)</b>
HP1	156B	2016	1299	2	Propane Furnace	Central AC	32.4
HP2	156C	2016	1136	2	Propane Furnace	Central AC	35.8
HP3	164	2017 (new)	1603	3	Na	Na	32.4
HP4	165	2017 (new)	1070	2	Na	Na	32.4
HP5	168B	2006	907	2	Kerosene Furnace	Central AC	30.2
HP6	168C	2000	1344	3	Kerosene Furnace	Central AC	34.8
HP7	361	1976	1134	2	Kerosene Furnace	Central AC	38.6
HP8	362	1978	1210	2	Kerosene Furnace	Window AC	34.3
HP9	363	2013	1256	2	Kerosene Furnace	Central AC	35.1
HP10	364	1975	1071	2	Kerosene Furnace	Central AC	34.3

Note: Manual J Heating Load estimated by HVAC contractor after estimating the impact of weatherization. Manual J peak heating loads should be based on the local (JFK) design temperature of 15°F, which is the 99% design condition.

## 2.2 Weatherization Improvements

A weatherization contractor was hired to improve the airtightness of the homes and in some cases add insulation. The homes were initially all very leaky, with values of ACH<sub>50</sub> between 10 to 20. The weatherization goal was to achieve 12 ACH<sub>50</sub>. The reduction in leakiness was typically 30-40%. Homes HP5, HP6, HP7 and HP8 all had spray foam applied under the floor. Appendix A compares the pre-retrofit fuel use to the post-retrofit measurement of loads to assess the impact of weatherization.

**Table 2. Air Tightness Improvements from Weatherization**

HP Unit No	House	Floor Area (sq ft)	Air Tightness Before and After Weatherization			Additional Insulation
			Before ACH <sub>50</sub> (1/h)	After ACH <sub>50</sub> (1/h)	Percent Reduction	
HP1	156B	1299				
HP2	156C	1136				
HP3	164	1603	New Home			
HP4	165	1070				
HP5	168B	907	12.6	6.7	47%	1100 sq ft spray foam under floor
HP6	168C	1334	9.9	7.6	23%	1200 sq ft spray foam under floor
HP7	361	1134	20.8	14	33%	1078 sq ft spray foam under floor
HP8	362	1210	12.8	10.9	15%	1078 sq ft spray foam under floor
HP9	363	1256				
HP10	364	1071	21.7	13.1	40%	Home weatherized previously by different program

Notes: ACH<sub>50</sub> is the air change rate of each home when pressurized to 50 Pascals with a blower door.

2 inches of spray foam applied under floor

Duct work for all units was sealed (spray-foamed, tape, mastic)

## 2.3 Description of Ground Loop and Heat Pumps

The GSHP units installed at each site were 3-ton Hydron Module dual stage units manufactured by Enertech Global. Conventional (packaged) GSHP units were installed in the two of the homes (XT series). In the other 8 homes the furnace closets were too small for a packaged unit, so a split unit was installed with a separate outdoor section connected to a DX indoor section (RT series). Table 3 lists the AHRI-rated performance for both units. The full and part load AHRI-rated COPs are 14 and 10% higher for the packaged unit than for the split unit. The HPs installed in each house are listed in Table 4. One commonly used metric to approximately estimate seasonal heating efficiency is to use the average of the full and part load AHRI-rated COPs. Those average values are 3.95 for the RT unit and 4.40 for the XT unit. The weighted average for the 10 HPs in this project is 4.0

**Table 3. Rated Performance Data for Hydron GSHP Units**

HP Unit No	Heating COP Full / Part	Heating Capacity (MBtu/h) Full / Part	Cooling EER (Btu/Wh) Full / Part	Cooling Capacity (MBtu/h) Full / Part
HRT036	3.7 / 4.2	27.4 / 21.8	16.0 / 24.5	35.5 / 27.6
HXT036	4.2 / 4.6	29.2 / 23.2	18.3 / 27.0	38.9 / 29.9

Notes: Rated performance data per ISO 13256-1 GLHP,  
 Heating conditions are 70°F indoors, 32°F EWT at full load, 41°F EWT at part load.  
 Cooling conditions are 81°F DB/ 66°F WB indoors, 77°F EW at full load, 68°F EWT at part load

**Table 4. Heat Pump Model Installed in Each House**

Unit No	House	HP Type	HP Model
HP1	156B	Split	HRT036
HP2	156C	Split	HRT036
HP3	164	Packaged	HXT036
HP4	165	Split	HRT036
HP5	168B	Split	HRT036

Unit No	House	HP Type	HP Model
HP6	168C	Split	HRT036
HP7	361	Packaged	HXT036
HP8	362	Split	HRT036
HP9	363	Split	HRT036
HP10	364	Split	HRT036

Figure 2 and Figure 3 show the outdoor section of the split unit. The photo in Figure 3 shows the flow center (pumps) mounted on the side of the outdoor unit. The BTU meter is being installed under the flow center.

Figure 2. Outdoor Section of “Split” GSHP Unit (RT series)



Datalogger Panel installed on Outdoor Unit



**Figure 3. Flow Center installed on Side of Outdoor Unit (with Onicon BTU Meter Shown)**

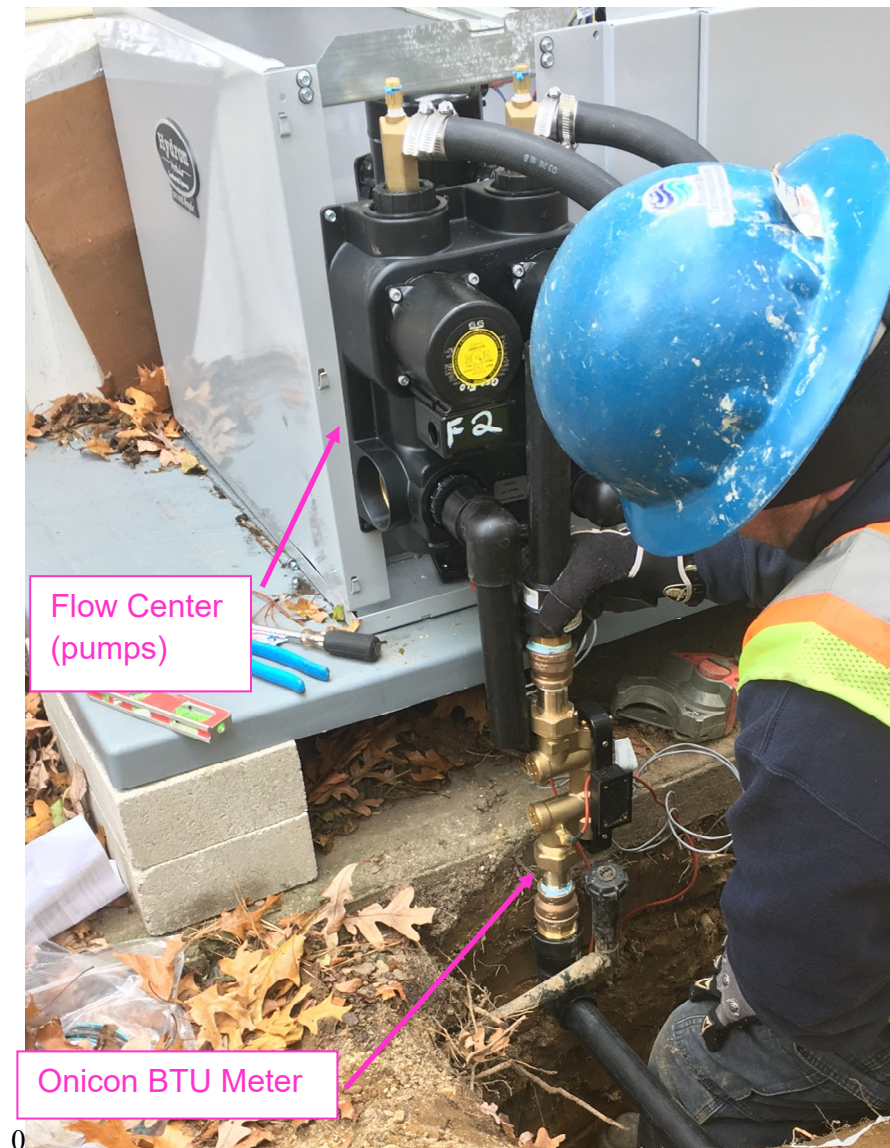
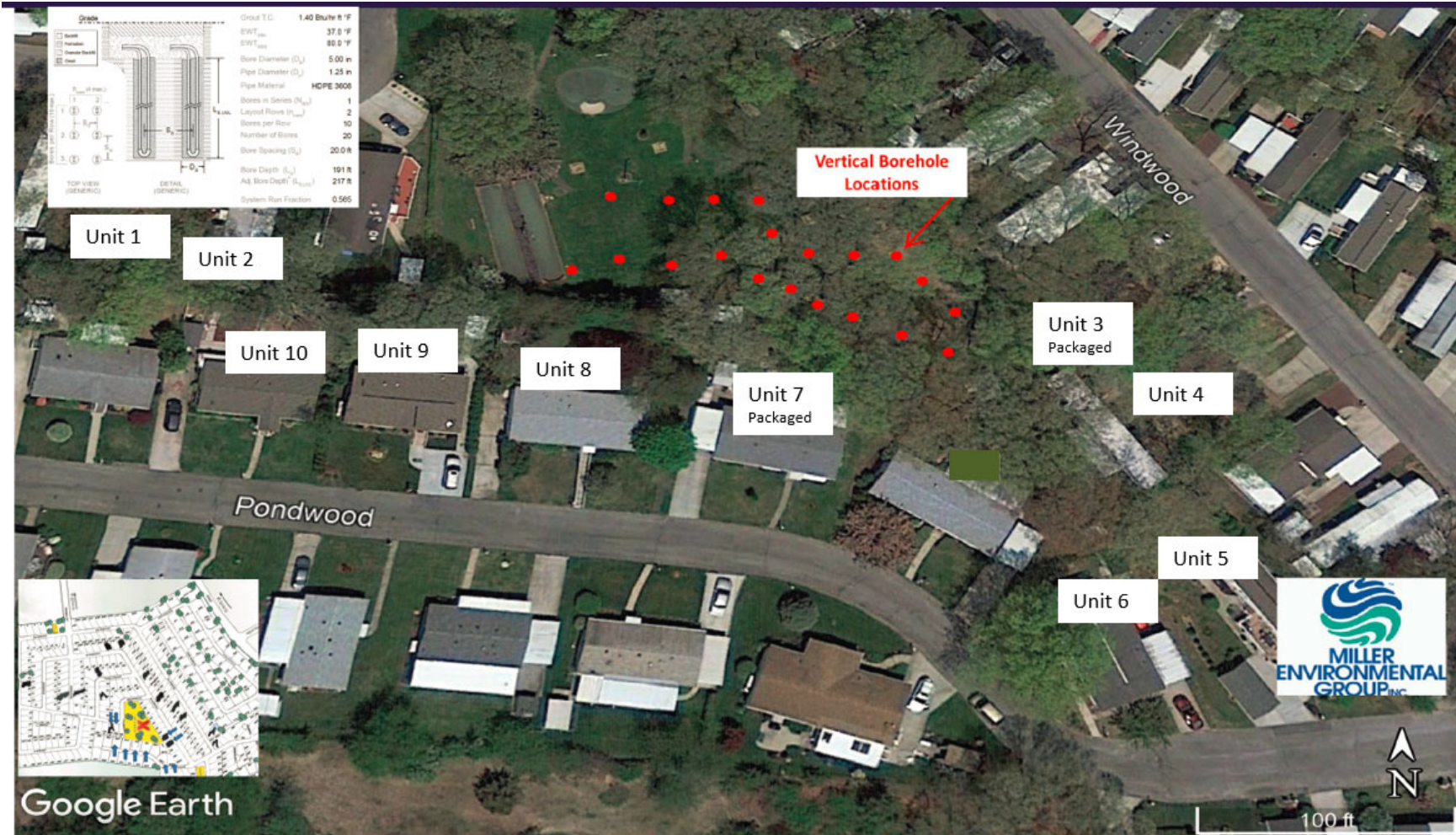


Figure 4 shows the layout of the vertical bores in the common areas between the homes. The loop was designed and sized to have a maximum entering water temperature of 80°F in the summer and a minimum entering water temperature of 37°F, as shown by the Geo Connections design details in Figure 5. The adjusted bore depth (that accounts for seasonal imbalances) from design report was 217 ft. The as-installed loop had 20 vertical bores that are 225 ft deep with 20 ft spacing between bores. The resulting ground loop has 150 ft of vertical bore per installed ton. The vertical bores are circuited together in a common loop. Then the 3-inch common header, schematically shown in Figure 6, has ten 1-½ inch circuits directed towards the heat pump at each home. Each heat pump has its own dedicated loop pump. The underground shut off valves for each heat pump circuit are accessible from the surface.

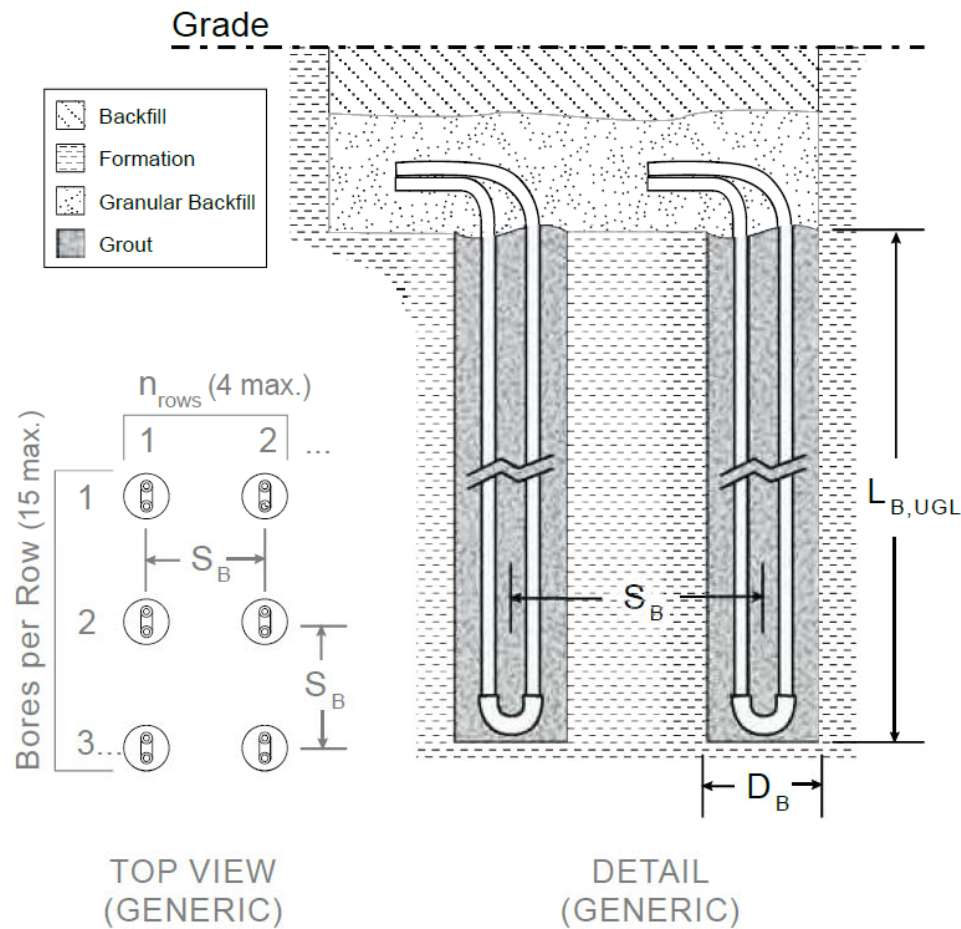


Figure 4. Layout of Ground Heat Exchanger and Homes on Common Loop



Map showing Vertical Bore and Home Locations (from National Grid Slides)

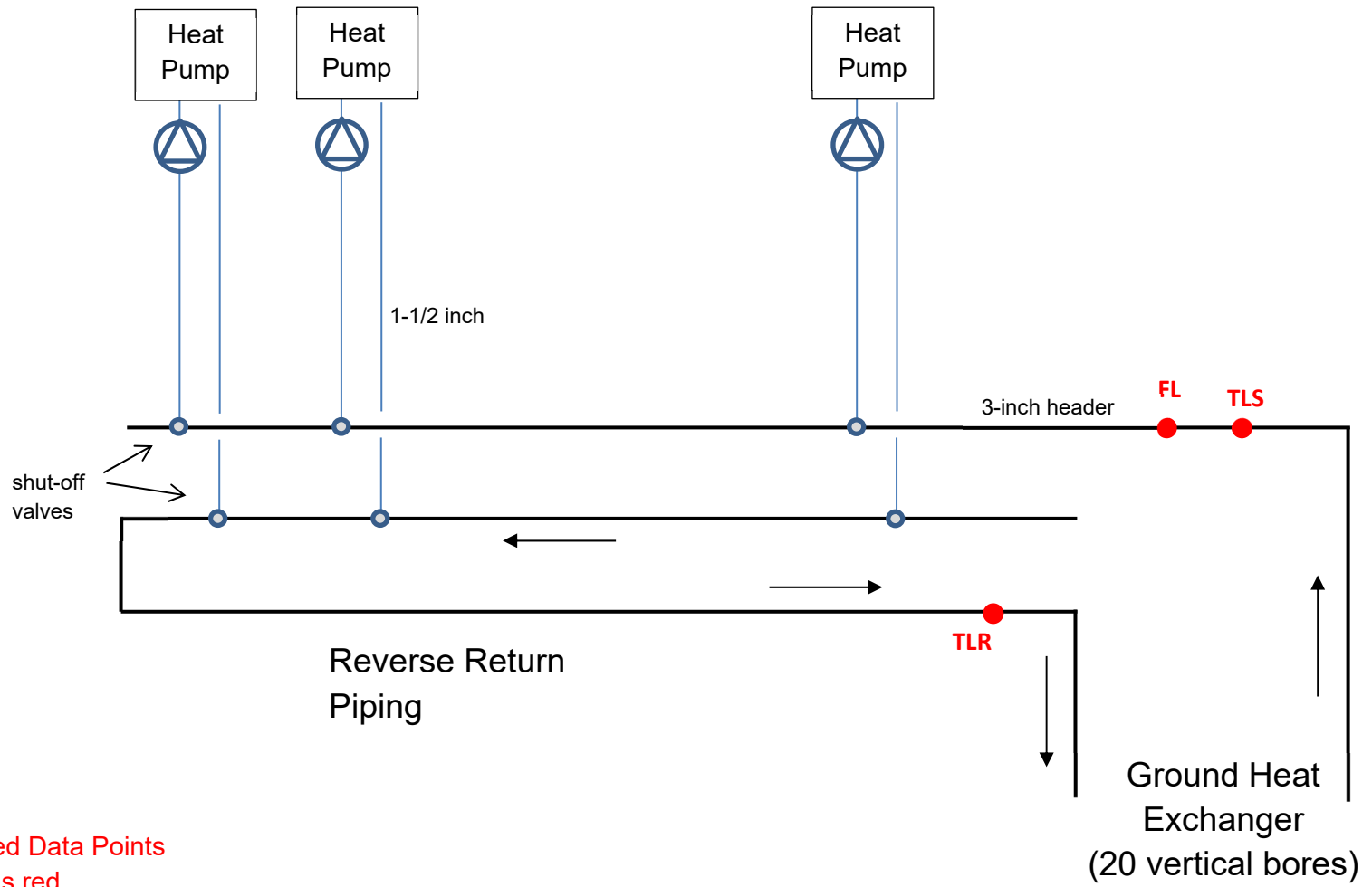
Figure 5. Ground Loop Design Details (from GSHP Design Report; loop sized based on heating loads)



Grout T.C.	1.40 Btu/hr ft °F
$EWT_{MIN}$	37.0 °F
$EWT_{MAX}$	80.0 °F
Bore Diameter ( $D_B$ )	5.00 in
Pipe Diameter ( $D_p$ )	1.25 in
Pipe Material	HDPE 3608
Bores in Series ( $N_{BIS}$ )	1
Layout Rows ( $n_{rows}$ )	2
Bores per Row	10
Number of Bores	20
Bore Spacing ( $S_B$ )	20.0 ft
Bore Depth ( $L_B$ )	191 ft
Adj. Bore Depth* ( $L_{B,UGL}$ )	217 ft
System Run Fraction	0.565

\*Adj. Bore Depth is the adjusted bore depth. This is the depth of bore that should be used to accommodate unbalanced ground loads over time.

Figure 6. Schematic of Common Loop Piping with Individual Pumping for Each Heat Pump



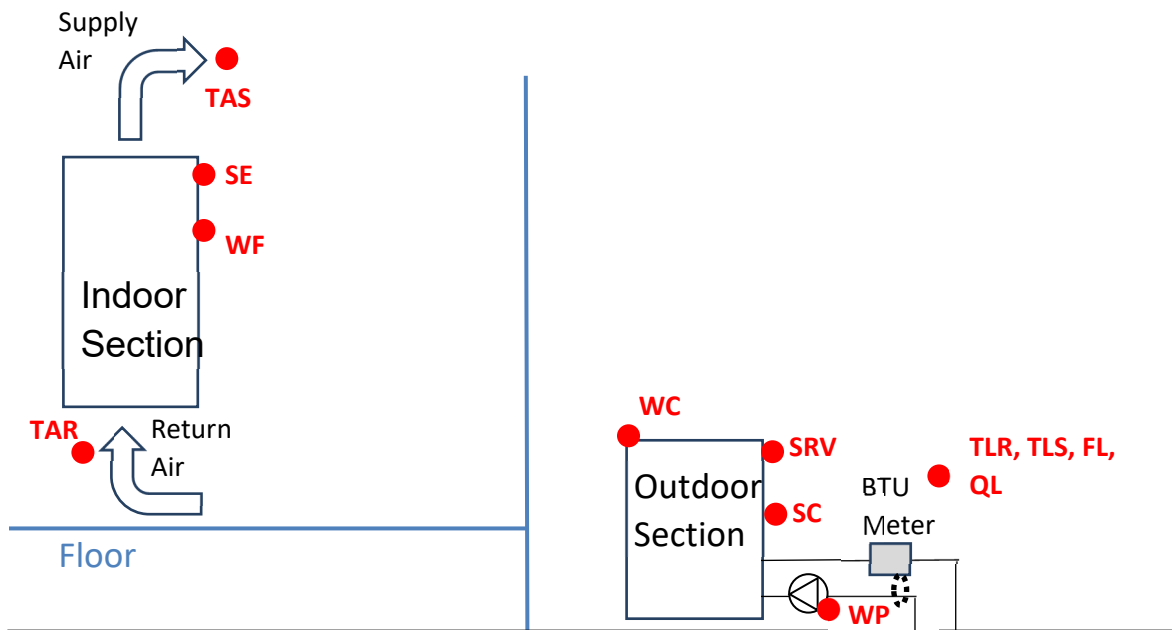
### 3 Monitoring Approach

In order to validate the performance of the ten ground source heat pumps on this community ground loop, we installed a central monitoring system with wireless connections to the sensors installed on the heat pumps installed at each home. The monitoring points were selected to measure the delivered heating and cooling capacity for each heat pump as well as measure the overall performance of the ground loop. The power use of the compressor, fan and pumps for each heat pump was also measured so that heating and cooling efficiency could also be determined. Various other points were also measured including: 1) the runtime of the resistance heat elements (to infer electric use), 2) the runtime or status of the compressor and reversing valve, and 3) air temperatures entering and leaving the heat pump unit

#### 3.1 Monitored Data Points and Data Collection

Figure 7 and Table 5 show the measured points installed on each heat pump unit. Table 6 shows the sensors installed on the common ground loop.

Figure 7. Schematic of a Heat Pump System with Measured Data Points Shown



**Table 5. Measured Data Points for each Heat Pump Unit**

Channel	Name	Description	Units	Accuracy	Instrument
Modbus	QL	Loop Heat (Reject/Extract)	Btu/h	±2%	Onicon System 40 BTU Meter
	FW	HP Loop Flow	gpm	±1%	
	TWS	HP Loop Supply	°F	±0.18°F	
	TWR	HP Loop Return	°F	±0.18°F	
I-1	WC	Comp Power	kWh	±3%	Wattnode OPT3
I-2	WF	Fan Power	kWh	±3%	
I-3	WP	Pump Power	kWh	±3%	
I-4	SE	Resistance Element Status	min	±2 sec	Veris 300 status CT
I-5	TAR	Return Air Temp	°F	±0.5°F	Thermistor type-2, 100k
I-6	TAS	Supply Air Temp	°F	±0.5°F	Thermistor type-2, 100k
I-7	SC	Compressor Status	min	±2 sec	Veris 300 status CT
I-8	SRV	Reversing Valve Status	min	±2 sec	Veris 300 status CT

**Table 6. Measured Data Points for the Common Ground Loop**

Channel	Name	Description	Units	Accuracy	Instrument
Modbus	QL_C	Loop Heat (Reject/Extract)	Btu/h	±1%	Onicon System 10 BTU w/ F1200 Flow Meter
	FW_C	Loop Flow	gpm	±0.5%	
	TWS_C	Loop Supply	F	±0.15°F	
	TWR_C	Loop Return	F	±0.15°F	

Note: these points are shown schematically on Figure 6

The overall approach was based around measuring the temperatures and flow on the loop-side of each heat pump with Onicon System 40 BTU meter (see Figure 3). This meter provided an accurate reading of the flow (**FL**), the supply and return temperature (**TWS**, **TSR**) and also calculated the integrated heat extracted or rejected to the loop (**QL**). We also installed a (Wattnode) power meter to measure compressor, fan and pumping power (**WC**, **WF**, **WP**)<sup>2</sup>. Status sensors were also installed to measure the runtime of the electric elements, compressor and reversing valve. (**SE**, **SC**, **SRV**). The air-side temperatures from the heat pumps (**TAS**, **TAR**) were also measured for diagnostic purposes and to determine space temperatures. Section 3.3 describes how these measured values are used to calculate the delivered heating and cooling capacity from each heat pump as well as its cooling and heating efficiency.

<sup>2</sup> A more advanced Modbus power meter was installed on HP10 compressor to provide an indication of the voltages at the site.

A Onicon System 10 BTU meter was also installed on the common ground loop to quantify the performance of the overall ground loop heat exchanger (see Table 6). The flow meter and loop temperature sensors were installed in an underground access hole.

The overall data logging system was based around an Obvius Aquisuite embedded datalogger. The data logger was installed in a tool shed near the common ground loop where power was available. The Onicon System 10 BTU meter was also installed in the shed. That meter measured flows and temperatures on the main loop. A wireless MODBUS “ModHopper” connection reached the expansion boards and Onicon System 40 BTU meter installed on each heat pump.

The data system collected data at 5-minute intervals. For statuses, powers, flows and heat, the readings were summed and accumulated over each interval. Air temperatures were averaged over the interval. In the first days of operation, we realized that a single Obvius datalogger could not successfully handle the wireless data transfer traffic for the more than 30 modbus devices installed at the site. As a result, a second Obvius Aquisuite “base” datalogger was installed to handle part of the wireless modbus traffic. The modbus devices on HPs 1, 2, 8, 9, and 10 were moved to the second datalogger. Even with the extra data logger installed, some 5-minute records were typically lost each day. The rate of data loss varied considerably across the 24-month monitoring period.

To address the issue of 5-minute data loss, we develop data analysis approaches that still provided accurate indications of overall performance using the accumulated data. For instance, to determine daily data, we looked at accumulator values at the beginning and end of each day (a similar process was used for hourly data). The difference in accumulator values across the day provided a direct indication of daily runtimes, electricity, and heat transfer. If values were missing at midnight our logic shifted as much 5 or 10-minutes either direction to find the closest valid reading. Similar approaches were used on a monthly basis.

## **3.2 One-Time Readings and Sensor Verification**

In addition to the continuously collected data shown in the table above, we took one-time measurements that could be correlated to the continuously collected data. The most important was the one-time measurement we took to confirm the electric use of the resistance elements. The rating of 4.8 kW was confirmed with our hand-held Fluke power meter.



The thermistors to measure air temperature were calibrated in the Frontier Energy office at our calibration test stand. Separate offset and multiplier were applied to the raw readings.

### 3.3 Calculated Quantities

The sections below show how heating and cooling performance are calculated. Both BTU meters report integrated heating as an absolute value, so the status of the reversing valve or direction of the temperature difference were required to know if heat was being rejected to or extracted from the ground loop. The equations below reflect the fact that QL is reported as an absolute value.

#### 3.3.1 Heating Performance.

The net heating capacity for each HP unit was calculated using Equation 1, based on a first-law heat balance (e.g., energy flows in and out of the system). The overall heating COP is calculated using Equation 2. The power readings are converted to kW for use in this equation. These equations only apply when the reversing valve status indicates that the unit is in the heating mode. Note that pumping power is not included in the heat balance calculations to find the heating capacity, but it is included to find COP.

**Equation 1**      $Q_H = Q_L + (W_C + W_F + W_E) * 3.412$

**Equation 2**      $COP = Q_H / (W_C + W_F + W_P + W_E) * 3.412$

In some of the analysis in this report, we also need to know the refrigerant-side or gross capacity of the unit – for instance for comparison with published performance data. For gross capacity and efficiency of the unit, the equations become:

**Equation 3**      $Q_{Hr} = Q_L + (W_C) * 3.412$

**Equation 4**      $COP_r = Q_{Hr} / (W_C) * 3.412$

#### 3.3.2 Cooling Performance

The gross cooling capacity for each unit was calculated using the heat balance equations below. In this case QL is heat rejection. The cooling equations only apply when the reversing valve status (or the loop temperatures) indicate that the unit is in the cooling mode.

**Equation 5**      $QC = QL - (WC + WF)*3.412$

**Equation 6**      $EER = QC / (WC + WF + WP)$

In some of the analysis in this report, we also need to know the refrigerant-side or gross cooling capacity of the unit – for instance for comparison with published performance data. For gross capacity and efficiency, the equations become:

**Equation 7**      $QC_r = QL - (WC)*3.412$

**Equation 8**      $COP_r = QC_r / (WC)$

### 3.4 Monitoring Period Timeline

The major milestones across the monitoring period are summarized in the table below. We visited the site several times to install and debug the monitoring systems. An additional monitoring trip was required since the 10<sup>th</sup> house was not complete until late Spring 2018. The first data on some homes started in late December 2017. Complete data collection on the first nine homes was fully established at the end of January 2018. Data collection for the 10<sup>th</sup> home started in May 2018. Data collection on the main or common loop flow meter was not working until June 20, 2018. Data collection continued through early 2020. This report uses the data collected through the end of 2019.

**Table 7. Milestones and Events Across the Monitoring Period**

Date	Milestone/Event
November 16-17, 2017	Installed sensors in indoor air handler units at HVAC contractor's facility before installation. Installed main data logger panel in storage shed.
Dec 20-21, 2017	Install remainder of sensors in indoor sections and install sensors on outdoor units (for 9 houses). Main flow meter installed but the System 10 BTU was mis-wired and failed. Sent to factory for replacement.
Jan 31, 2018	Trouble shoot communications issues between main logger and wireless satellite loggers. Added a second Obvius data logger to improve data collection. System 10 BTU meter fixed, main loop data collected for a few days and then stopped.
May 2, 2018	Installed sensors on 10 <sup>th</sup> house. Onicon flow meter electronics were found to be full of water. Send back to factory for repair.
June 20, 2018	Repaired Onicon flow meter installed by Miller Environmental staff. Normal data collection resumes.
September 6, 2018	Test confirmed HP2 piping was reversed
November 6, 2018	Loop piping fixed for HP2
April 2019	Data loss increased in late winter 2019. Optimized data logger networking/programming to improve data collection rate.
January 31, 2020	Cellular Modem operation ceased.

## 4 Results and Analysis

---

The 5-minute data was used to analyze various aspects of system performance. The data were also assembled into hourly, daily and monthly intervals to facilitate the higher-level analysis (by using accumulator readings as described in section 3). The plots and tables in this section use either the 5-minute, hourly, daily or monthly data to understand performance.

### 4.1 Summary of Energy Use and Operating Patterns

Data collection for most of the HP units began in February 2018 and continued through December 2019. Table 9 through Table 18 summarize the monthly energy use, load data, and efficiency for each HP unit. For some months data were not available. The percentage of good 5-minute records are shown for each month, for both the BTU meter and expansion board. The monthly values were mostly constructed using accumulator data (i.e., taking the difference between the accumulated reading at the beginning and the end of each month). Therefore, the monthly values were not affected by the loss of 5-minute data.

Average indoor temperatures were determined by only averaging return temperatures when the unit was operating.

The data for HP4 did not start until May 2018, since this house not completed and occupied until late Spring 2018. The bottom of the table also lists the annual totals for 2018, 2019 and a 12-month period from July 2018 through June 2019. **The July 2018 to June 2019 period is most representative of annual performance since all data was collected for all systems in this period. Therefore, all annual performance results discussed in the remainder of the report are based on this period.**

Table 8 summarizes the annual data for each site during the July 2018 to June 2018 period. The seasonal heating COPs ranged from 2.20 to 3.71, with an average of 2.83 – lower than expectations. The weighted average of the full and part load AHRI-rated heating COP for these 10 sites is 4.0 (as discussed in Section 2.3). The measured average seasonal COP is 70% of this approximate efficiency metric using AHRI-rated values<sup>3</sup>.

The annual heating loads ranged from 22.8 to 41.5 MMBtu, with an average of 31.0 MMBtu. Appendix B compares the daily heating loads to the reported Manual J heating load from the contractor. The measured heating loads were typically more modest than the expected peak loads based on Manual J.

---

<sup>3</sup> In comparison, the field study of 49 GSHPs in Upstate NY (NYSERDA Report 18-03) found the measured COPs in a colder climate were 3.63, or 83% of the weighted-average full and part load AHRI-rated heating COPs.

Since the heat pump size was based on the Manual J peak loads, the units were generally larger than the actual heating loads.

Most homes had one or two months of overlapping heating and cooling operation in the spring and fall. HP10 had cooling operation in almost every month of the year. There were never any sites during the 24-month monitoring period when cooling and heating operation occurred in the same day. The seasonal cooling EERs ranged from 9.5 to 15.1 Btu/Wh, with an average of 12.2 Btu/Wh. Generally, the seasonal cooling efficiencies are lower than expected, presumably due excessive cycling of the oversized unit (e.g., the larger cooling capacity of the unit and the smaller cooling load results in excess capacity for cooling). Annual cooling loads ranged from 2.9 to 21.6 MMBtu, with an average of 11.9 MMBtu. Many of the differences in cooling load are explained by different cooling set point temperatures. At the three homes the highest annual cooling load (HP2, HP3 and HP4) the cooling set points were especially low (71°F, 66°F and 70°F, respectively). At these homes the annual cooling load was 60% or more of the annual heating load.

HP3 and HP7, which were the two packaged units, were also observed to have the highest seasonal average heating COPs (3.71 and 3.50, respectively). Table 3 shows that the rated heating COPs at full and part-load were 10% and 14% higher for the packaged unit.

**Table 8. Annual Energy Use, Loads and Efficiencies for All Units for July 2018 thru June 2019**

Unit	Comp Power (kWh)	Fan Power (kWh)	Pump Power (kWh)	Total Power (kWh)	Comp Runtime (hrs)	Electric Element Runtime (hrs)	Heating Load (MBtu)	Cooling Load (MBtu)	Net Heating COP (-)	Cooling EER (Btu/Wh)	Indoor Temp Htg (F)	Indoor Temp Clg (F)
HP1	3,401	1,336	782	5,520	2,343	-	33,263	10,097	2.20	9.5	74.7	75.1
HP2	3,697	820	510	5,027	2,629	-	33,196	21,645	2.92	12.8	70.2	70.5
HP3	2,821	427	310	3,557	1,835	-	28,350	18,647	3.71	14.2	65.7	65.8
HP4	3,587	614	635	4,835	2,009	-	26,747	15,720	2.48	9.8	73.2	69.8
HP5	1,864	633	515	3,043	1,450	6	22,878	5,068	2.55	12.8	65.5	75.1
HP6	3,715	739	875	5,674	2,375	72	39,434	9,272	2.40	11.9	70.3	75.6
HP7	2,664	367	595	3,626	1,857	-	34,239	10,924	3.50	15.1	64.8	74.3
HP8	3,270	642	690	4,851	2,102	52	41,491	2,958	2.74	10.4	63.6	75.1
HP9	2,284	338	509	3,132	1,548	-	23,072	9,392	2.81	12.4	69.0	72.9
HP10	2,934	427	330	3,693	2,341	0	27,466	14,886	2.95	13.4	61.4	71.8
Average	3,024	634	575	4,296	2,049		31,014	11,861	2.83	12.2	67.8	72.6

Notes: Indoor heating temperatures are average of November to March in the 2018-2019 period. Indoor cooling temperatures are average of May to September in the period.

The next section seeks to explain the performance differences between the sites.

**Table 9. Monthly Energy Use, Loads and Efficiencies for HP Unit 1**

2	Unit 1													Loop Supply Temp (F)	Indoor Temp (F)			
	No of Days	Good Records (Btu Mtr)	Good Records (Exp Brd)	Compressor Power (kWh)	Fan Power (kWh)	Pump Power (kWh)	Total Power (kWh)	Comp Runtime (hrs)	Electric Element Runtime (hrs)	Heating Load (MBtu)	Cooling Load (MBtu)	Net Heating COP (-)	Cooling EER (Btu/Wh)					
Jan-18	31	1%	1%	-	-	-	-	-	-	-	-	-	-	-	-	-	-	
Feb-18	28	98%	96%	<b>380.1</b>	<b>135.9</b>	<b>87.5</b>	<b>603.5</b>	<b>257.6</b>	-	<b>4,483.1</b>	-	<b>2.18</b>	-	-	-	44.3	72.5	
Mar-18	31	97%	94%	<b>437.7</b>	<b>153.3</b>	<b>100.3</b>	<b>691.3</b>	<b>293.2</b>	-	<b>5,140.2</b>	-	<b>2.18</b>	-	-	-	44.8	72.9	
Apr-18	30	96%	93%	<b>270.1</b>	<b>106.8</b>	<b>61.5</b>	<b>438.5</b>	<b>180.5</b>	-	<b>3,231.0</b>	-	<b>2.16</b>	-	-	-	47.2	73.6	
May-18	31	98%	97%	<b>43.0</b>	<b>50.7</b>	<b>12.8</b>	<b>106.5</b>	<b>38.2</b>	-	<b>201.7</b>	<b>586.8</b>	<b>1.87</b>	<b>8.1</b>	-	-	58.6	72.2	
Jun-18	30	100%	100%	<b>65.1</b>	<b>54.0</b>	<b>20.0</b>	<b>139.1</b>	<b>60.9</b>	-	-	<b>1,231.4</b>	-	<b>8.9</b>	-	-	66.3	74.0	
Jul-18	31	100%	99%	<b>186.5</b>	<b>84.6</b>	<b>52.5</b>	<b>323.6</b>	<b>160.9</b>	-	-	<b>3,260.6</b>	-	<b>10.1</b>	-	-	71.4	75.8	
Aug-18	31	100%	100%	<b>195.3</b>	<b>87.8</b>	<b>54.3</b>	<b>337.3</b>	<b>167.9</b>	-	-	<b>3,378.3</b>	-	<b>10.0</b>	-	-	72.3	75.8	
Sep-18	30	100%	100%	<b>74.1</b>	<b>54.6</b>	<b>20.4</b>	<b>149.1</b>	<b>62.4</b>	-	-	<b>1,201.6</b>	-	<b>8.1</b>	-	-	72.7	75.2	
Oct-18	31	99%	98%	<b>140.7</b>	<b>74.2</b>	<b>31.6</b>	<b>246.5</b>	<b>92.9</b>	-	<b>1,584.9</b>	<b>191.3</b>	<b>2.20</b>	<b>5.3</b>	-	-	61.4	74.6	
Nov-18	30	96%	92%	<b>346.9</b>	<b>126.5</b>	<b>75.7</b>	<b>549.2</b>	<b>226.0</b>	-	<b>4,206.6</b>	-	<b>2.25</b>	-	-	-	50.8	75.1	
Dec-18	31	93%	87%	<b>477.1</b>	<b>161.2</b>	<b>104.3</b>	<b>742.6</b>	<b>311.1</b>	-	<b>5,605.9</b>	-	<b>2.21</b>	-	-	-	47.6	74.6	
Jan-19	31	74%	60%	<b>607.8</b>	<b>195.8</b>	<b>131.1</b>	<b>934.6</b>	<b>391.6</b>	-	<b>7,077.2</b>	-	<b>2.22</b>	-	-	-	45.5	74.5	
Feb-19	28	55%	34%	<b>523.0</b>	<b>170.8</b>	<b>113.7</b>	<b>807.6</b>	<b>342.1</b>	-	<b>5,998.0</b>	-	<b>2.18</b>	-	-	-	44.3	74.6	
Mar-19	31	64%	44%	<b>458.9</b>	<b>160.7</b>	<b>101.5</b>	<b>721.2</b>	<b>299.2</b>	-	<b>5,219.2</b>	-	<b>2.12</b>	-	-	-	45.4	74.8	
Apr-19	30	90%	82%	<b>197.6</b>	<b>89.7</b>	<b>44.1</b>	<b>331.4</b>	<b>130.2</b>	-	<b>2,426.6</b>	-	<b>2.15</b>	-	-	-	50.1	75.3	
May-19	31	93%	88%	<b>96.0</b>	<b>64.8</b>	<b>23.2</b>	<b>184.0</b>	<b>69.0</b>	-	<b>1,144.2</b>	<b>320.6</b>	<b>2.36</b>	<b>7.6</b>	-	-	55.2	75.1	
Jun-19	30	97%	95%	<b>97.5</b>	<b>65.4</b>	<b>29.6</b>	<b>192.5</b>	<b>90.0</b>	-	-	<b>1,744.2</b>	-	<b>9.1</b>	-	-	62.4	73.5	
Jul-19	31	98%	97%	<b>252.0</b>	<b>110.6</b>	<b>70.6</b>	<b>433.3</b>	<b>219.1</b>	-	-	<b>4,365.9</b>	-	<b>10.1</b>	-	-	67.7	75.0	
Aug-19	31	98%	97%	<b>154.8</b>	<b>80.0</b>	<b>44.2</b>	<b>279.0</b>	<b>135.9</b>	-	-	<b>2,603.9</b>	-	<b>9.3</b>	-	-	67.9	74.6	
Sep-19	30	95%	91%	<b>45.6</b>	<b>49.5</b>	<b>13.2</b>	<b>108.3</b>	<b>40.1</b>	-	-	<b>736.2</b>	-	<b>6.8</b>	-	-	65.9	73.6	
Oct-19	31	88%	79%	<b>116.6</b>	<b>69.7</b>	<b>26.5</b>	<b>212.8</b>	<b>78.6</b>	-	<b>1,504.5</b>	<b>75.6</b>	<b>2.18</b>	<b>7.1</b>	-	-	59.2	76.0	
Nov-19	30	72%	52%	<b>377.8</b>	<b>139.7</b>	<b>84.6</b>	<b>602.1</b>	<b>251.1</b>	-	<b>4,594.4</b>	-	<b>2.24</b>	-	-	-	51.3	75.2	
Dec-19	31	58%	31%	<b>493.3</b>	<b>172.7</b>	<b>109.9</b>	<b>777.5</b>	<b>327.4</b>	<b>0.3</b>	<b>5,829.3</b>	-	<b>2.20</b>	-	-	-	47.5	75.2	
2018	365			2,617	1,090	621	4,327	1,852	-	24,453	9,850	2.19	9.3					
2019	365			3,421	1,369	792	5,584	2,374	0.3	33,793	9,846	2.19	9.2					
2018-2019	365			3,401	1,336	782	5,520	2,343	-	33,263	10,097	2.20	9.5					
																	Winter	74.7
																	Summer	75.1

Notes: **Bold** values based on cumulative monthly readings. Setpoint was 75°F year-round.

**Table 10. Monthly Energy Use, Loads and Efficiencies for HP Unit 2**

2	Unit 2													Loop Supply Temp (F)	Indoor Temp (F)
	No of Days	Good Records (Btu Mtr)	Good Records (Exp Brd)	Compressor Power (kWh)	Fan Power (kWh)	Pump Power (kWh)	Total Power (kWh)	Comp Runtime (hrs)	Electric Element Runtime (hrs)	Heating Load (MBtu)	Cooling Load (MBtu)	Net Heating COP (-)	Cooling EER (Btu/Wh)		
Jan-18	31	83%	79%	-	-	-	-	-	-	-	-	-	-	37.9	-
Feb-18	28	98%	96%	370.2	80.3	67.4	518.0	249.6	-	4,898.1	-	2.77	-	41.4	71.2
Mar-18	31	97%	94%	413.1	90.3	78.9	582.3	279.0	-	5,521.8	-	2.78	-	41.2	69.9
Apr-18	30	96%	93%	192.6	41.0	37.5	271.1	127.4	-	2,683.3	-	2.91	-	44.2	68.8
May-18	31	98%	97%	85.7	21.8	17.2	124.7	69.9	-	390.5	1,361.2	7.24	14.2	60.0	70.2
Jun-18	30	100%	100%	187.9	47.2	26.7	261.8	153.2	-	-	3,484.1	-	13.3	71.1	69.8
Jul-18	31	99%	99%	397.9	92.2	51.8	541.9	300.9	-	-	6,741.3	-	12.4	77.6	70.4
Aug-18	31	100%	100%	400.0	89.6	55.5	545.1	295.3	-	-	6,649.5	-	12.2	79.1	71.2
Sep-18	30	100%	100%	187.7	43.0	24.3	255.0	140.0	-	-	3,107.4	-	12.2	76.5	70.8
Oct-18	31	98%	98%	149.5	32.6	19.9	201.9	102.0	-	1,803.0	519.5	3.24	13.4	61.8	71.0
Nov-18	30	93%	89%	325.4	68.0	44.5	438.0	216.4	-	4,414.4	-	2.95	-	50.5	71.9
Dec-18	31	89%	83%	446.7	94.4	61.4	602.5	300.3	-	5,974.3	-	2.91	-	47.7	70.2
Jan-19	31	66%	54%	605.5	127.7	82.7	815.9	407.4	-	8,035.8	-	2.89	-	45.8	71.0
Feb-19	28	45%	26%	466.6	100.1	64.8	631.5	320.9	-	6,172.6	-	2.86	-	44.7	70.1
Mar-19	31	55%	37%	364.7	80.0	51.6	496.3	251.7	-	4,847.2	-	2.86	-	46.2	67.8
Apr-19	30	86%	80%	108.3	23.5	16.0	147.8	74.1	-	1,507.0	-	2.99	-	50.5	69.0
May-19	31	93%	88%	74.7	20.1	12.4	107.2	64.1	-	441.3	1,070.8	3.63	15.1	56.0	70.0
Jun-19	30	97%	95%	169.8	48.4	25.6	243.8	156.2	-	-	3,556.2	-	14.6	63.3	69.9
Jul-19	31	98%	97%	375.4	96.7	56.7	528.9	317.5	-	-	7,214.8	-	13.6	68.3	69.8
Aug-19	31	98%	97%	265.6	70.4	35.7	371.7	229.4	-	-	4,617.4	-	12.4	69.0	69.5
Sep-19	30	4%	88%	56.0	15.3	7.9	79.1	49.4	-	-	-	-	-	69.0	70.2
Oct-19	31	0%	83%	120.5	25.2	16.9	162.6	79.6	-	433.3	-	0.86	-	-	72.8
Nov-19	30	0%	55%	337.8	70.9	47.3	456.0	224.2	-	1,394.5	-	0.90	-	-	71.3
Dec-19	31	0%	34%	511.3	105.4	70.2	686.9	334.8	-	2,104.7	-	0.90	-	-	73.3
2018	365			3,157	700	485	4,342	2,234	-	25,685	21,863	2.95	12.6		
2019	365			3,456	784	488	4,728	2,509	-	24,936	16,459	2.58	12.6		
2018-2019	365			3,697	820	510	5,027	2,629	-	33,196	21,645	2.92	12.8	Winter	70.2
														Summer	70.5

Notes: **Bold** values based on cumulative monthly readings. The occupants changed at the end of September 2018. Setpoint was 70°F year-round. BTU meter failed at the end of 2019 (causing low COPs)



**Table 11. Monthly Energy Use, Loads and Efficiencies for HP Unit 3**

2	Unit 3													Loop Supply Temp (F)	Indoor Temp (F)
	No of Days	Good Records (Btu Mtr)	Good Records (Exp Brd)	Compressor Power (kWh)	Fan Power (kWh)	Pump Power (kWh)	Total Power (kWh)	Comp Runtime (hrs)	Electric Element Runtime (hrs)	Heating Load (MBtu)	Cooling Load (MBtu)	Net Heating COP (-)	Cooling EER (Btu/Wh)		
Jan-18	31	90%	81%	-	-	-	-	-	-	-	-	-	-	41.3	65.9
Feb-18	28	98%	96%	444.3	57.9	112.6	614.8	276.9	-	6,487.1	-	3.09	-	44.9	66.9
Mar-18	31	96%	94%	476.4	65.8	68.9	611.1	289.6	-	6,938.5	-	3.33	-	44.6	66.6
Apr-18	30	95%	93%	284.8	40.5	27.3	352.5	178.2	-	4,220.2	-	3.51	-	46.5	66.3
May-18	31	98%	97%	74.1	16.9	7.1	98.1	47.0	-	415.6	1,045.3	6.84	12.9	58.8	65.0
Jun-18	30	99%	99%	154.3	32.6	14.8	201.7	93.7	-	-	2,721.2	-	13.5	65.3	64.8
Jul-18	31	98%	96%	310.6	57.5	30.3	398.5	181.0	-	-	5,432.7	-	13.6	68.8	63.7
Aug-18	31	98%	96%	339.1	62.7	31.6	433.3	190.0	-	-	5,780.4	-	13.4	70.6	63.3
Sep-18	30	98%	97%	104.7	20.3	10.0	135.1	59.9	-	-	1,893.3	-	13.9	70.7	68.6
Oct-18	31	96%	93%	110.7	16.2	11.7	138.5	68.2	-	1,287.7	509.0	3.68	13.9	61.2	66.6
Nov-18	30	94%	88%	208.7	26.4	24.3	259.4	143.5	-	3,470.9	-	3.92	-	50.1	63.5
Dec-18	31	89%	80%	314.1	37.8	35.5	387.4	209.4	-	5,018.1	79.2	3.80	17.6	46.9	66.0
Jan-19	31	79%	64%	438.7	51.4	49.0	539.1	290.5	-	6,660.1	-	3.62	-	44.2	65.6
Feb-19	28	76%	53%	343.2	40.6	38.3	422.0	227.8	-	5,102.6	-	3.54	-	43.2	66.2
Mar-19	31	78%	59%	317.8	38.2	34.9	390.9	205.3	-	4,658.3	8.2	3.49	20.5	44.4	67.3
Apr-19	30	90%	81%	83.1	12.5	9.5	105.1	55.8	-	1,418.2	111.9	4.20	16.7	50.5	65.4
May-19	31	100%	100%	77.6	22.7	10.0	110.3	58.4	-	734.6	1,051.0	4.56	16.6	56.3	67.0
Jun-19	30	100%	100%	172.8	40.3	24.8	237.9	145.4	-	-	3,780.8	-	15.9	61.5	66.3
Jul-19	31	100%	100%	375.7	56.1	49.1	480.9	294.4	-	-	7,638.3	-	15.9	67.0	66.9
Aug-19	31	100%	100%	292.6	43.9	39.1	375.5	232.1	-	-	5,971.0	-	15.9	67.2	66.9
Sep-19	30	100%	100%	151.6	23.1	21.9	196.7	129.2	-	-	3,230.1	-	16.4	65.7	66.7
Oct-19	31	100%	99%	34.6	8.4	4.4	47.4	25.8	-	345.5	410.1	4.82	15.2	58.6	66.3
Nov-19	30	99%	98%	233.9	30.2	26.1	290.2	152.9	-	3,761.7	22.7	3.82	17.5	50.7	66.9
Dec-19	31	99%	99%	346.8	44.0	38.7	429.4	227.4	-	5,357.3	-	3.66	-	46.7	66.8
2018	365			2,822	435	374	3,630	1,738	-	27,838	17,461	3.53	13.5		
2019	365			2,868	411	346	3,626	2,045	-	28,038	22,224	3.69	16.0		
2018-2019	365			2,821	427	310	3,557	1,835	-	28,350	18,647	3.71	14.2	Winter	65.7
														Summer	65.8

Notes: **Bold** values based on cumulative monthly readings. Setpoint was 66°F year-round.

**Table 12. Monthly Energy Use, Loads and Efficiencies for HP Unit 4**

2	Unit 4													Loop Supply Temp (F)	Indoor Temp (F)		
	No of Days	Good Records (Btu Mtr)	Good Records (Exp Brd)	Compressor Power (kWh)	Fan Power (kWh)	Pump Power (kWh)	Total Power (kWh)	Comp Runtime (hrs)	Electric Element Runtime (hrs)	Heating Load (MBtu)	Cooling Load (MBtu)	Net Heating COP (-)	Cooling EER (Btu/Wh)				
Jan-18	31	0%	0%	-	-	-	-	-	-	-	-	-	-	-	-	-	-
Feb-18	28	0%	0%	-	-	-	-	-	-	-	-	-	-	-	-	-	-
Mar-18	31	0%	0%	-	-	-	-	-	-	-	-	-	-	-	-	-	-
Apr-18	30	0%	0%	-	-	-	-	-	-	-	-	-	-	-	-	-	-
May-18	31	94%	93%	-	-	-	-	-	-	-	-	224.1	-	-	1.6	60.5	70.4
Jun-18	30	99%	99%	<b>204.3</b>	<b>31.3</b>	<b>39.2</b>	<b>274.9</b>	<b>114.2</b>	-	-	2,638.1	-	-	9.7	68.4	68.9	
Jul-18	31	94%	91%	<b>338.3</b>	<b>43.8</b>	<b>59.1</b>	<b>441.2</b>	<b>191.1</b>	-	-	4,231.2	-	-	9.6	75.0	68.8	
Aug-18	31	97%	96%	<b>358.6</b>	<b>48.1</b>	<b>62.8</b>	<b>469.5</b>	<b>204.7</b>	-	-	4,460.0	-	-	9.5	76.1	69.3	
Sep-18	30	96%	94%	<b>205.6</b>	<b>25.5</b>	<b>35.8</b>	<b>266.9</b>	<b>114.9</b>	-	-	2,428.1	-	-	9.1	74.9	70.7	
Oct-18	31	90%	87%	<b>154.9</b>	<b>25.4</b>	<b>27.2</b>	<b>207.5</b>	<b>85.0</b>	-	1,189.5	688.2	2.66	9.0	62.2	72.5		
Nov-18	30	85%	76%	<b>274.3</b>	<b>52.1</b>	<b>49.6</b>	<b>376.0</b>	<b>153.9</b>	-	3,214.3	-	2.51	-	50.4	73.3		
Dec-18	31	80%	67%	<b>420.4</b>	<b>80.3</b>	<b>75.0</b>	<b>575.7</b>	<b>236.3</b>	-	4,875.7	-	2.48	-	46.7	73.4		
Jan-19	31	69%	49%	<b>553.6</b>	<b>103.9</b>	<b>98.2</b>	<b>755.8</b>	<b>309.8</b>	-	6,407.5	-	2.48	-	44.6	73.5		
Feb-19	28	64%	37%	<b>446.0</b>	<b>86.1</b>	<b>79.7</b>	<b>611.9</b>	<b>252.9</b>	-	5,104.6	-	2.44	-	43.0	72.9		
Mar-19	31	64%	36%	<b>381.6</b>	<b>74.1</b>	<b>67.3</b>	<b>523.1</b>	<b>208.8</b>	-	4,261.9	-	2.39	-	44.3	72.7		
Apr-19	30	40%	34%	<b>118.5</b>	<b>23.1</b>	<b>21.1</b>	<b>162.8</b>	<b>65.6</b>	-	962.4	-	2.60	-	49.1	72.8		
May-19	31	100%	100%	<b>123.5</b>	<b>21.0</b>	<b>21.8</b>	<b>166.3</b>	<b>68.6</b>	-	731.3	1,232.6	2.83	13.6	55.9	71.6		
Jun-19	30	100%	100%	<b>211.3</b>	<b>30.6</b>	<b>36.9</b>	<b>278.8</b>	<b>117.2</b>	-	-	2,679.5	-	9.6	64.3	68.5		
Jul-19	31	100%	100%	<b>420.7</b>	<b>57.9</b>	<b>72.9</b>	<b>551.5</b>	<b>234.4</b>	-	-	5,226.7	-	9.5	69.8	67.9		
Aug-19	31	100%	100%	<b>316.8</b>	<b>42.9</b>	<b>55.1</b>	<b>414.8</b>	<b>176.3</b>	-	-	3,882.6	-	9.4	70.3	68.5		
Sep-19	30	100%	100%	<b>171.6</b>	<b>25.1</b>	<b>30.0</b>	<b>226.7</b>	<b>95.6</b>	-	-	2,166.4	-	9.6	67.3	68.4		
Oct-19	31	100%	99%	<b>73.9</b>	<b>13.5</b>	<b>13.1</b>	<b>100.4</b>	<b>41.3</b>	-	704.6	489.9	3.37	12.5	60.1	71.9		
Nov-19	30	99%	97%	<b>252.9</b>	<b>48.1</b>	<b>44.9</b>	<b>346.0</b>	<b>139.8</b>	-	3,276.8	20.7	2.79	15.9	50.8	73.0		
Dec-19	31	99%	98%	<b>370.0</b>	<b>70.0</b>	<b>65.8</b>	<b>505.8</b>	<b>204.9</b>	-	4,579.9	-	2.65	-	46.6	72.7		
2018	365			1,956	307	349	2,612	1,100	-	9,280	14,670	2.51	8.8				
2019	365			3,440	596	607	4,644	1,915	-	26,029	15,698	2.57	9.8				
2018-2019	365			3,587	614	635	4,835	2,009	-	26,747	15,720	2.48	9.8	Winter		73.2	
														Summer		69.8	

Notes: **Bold** values based on cumulative monthly readings. Monitoring started in early May 2018.

**Table 13. Monthly Energy Use, Loads and Efficiencies for HP Unit 5**

2	Unit 5														Loop Supply Temp (F)	Indoor Temp (F)
	No of Days	Good Records (Btu Mtr)	Good Records (Exp Brd)	Compressor Power (kWh)	Fan Power (kWh)	Pump Power (kWh)	Total Power (kWh)	Comp Runtime (hrs)	Electric Element Runtime (hrs)	Heating Load (MBtu)	Cooling Load (MBtu)	Net Heating COP (-)	Cooling EER (Btu/Wh)			
Jan-18	31	85%	76%	-	-	-	-	-	-	4,782.3	-	2.38	-	40.3	70.7	
Feb-18	28	98%	96%	372.2	121.9	85.7	579.8	263.1	-	4,752.7	-	2.40	-	43.7	70.7	
Mar-18	31	96%	94%	377.4	124.1	88.7	590.1	270.6	-	4,945.7	-	2.46	-	44.1	68.9	
Apr-18	30	95%	93%	219.1	73.9	52.2	345.3	160.2	-	2,895.7	-	2.46	-	46.7	69.5	
May-18	31	98%	97%	22.2	7.7	5.4	35.3	16.6	-	358.1	62.9	3.50	12.3	57.8	73.6	
Jun-18	30	99%	99%	25.3	6.3	6.8	38.3	21.5	-	-	498.9	-	13.0	66.9	74.9	
Jul-18	31	95%	94%	95.4	22.1	25.6	143.1	81.4	-	-	1,825.2	-	12.8	73.1	76.8	
Aug-18	31	97%	96%	98.1	22.5	25.6	146.2	82.5	-	-	1,855.6	-	12.7	74.3	76.7	
Sep-18	30	96%	94%	31.5	7.9	8.2	47.7	26.3	-	-	592.3	-	12.4	72.8	75.1	
Oct-18	31	93%	91%	62.9	21.8	15.9	100.6	48.6	-	802.1	152.1	2.67	12.5	61.5	69.5	
Nov-18	30	90%	84%	245.9	85.1	59.4	390.4	184.9	-	3,437.9	-	2.58	-	50.4	68.4	
Dec-18	31	85%	78%	162.7	65.3	45.6	273.6	141.5	-	2,681.8	-	2.87	-	46.1	58.9	
Jan-19	31	76%	62%	438.6	150.4	106.4	695.4	327.8	-	6,142.1	-	2.59	-	44.0	66.1	
Feb-19	28	73%	54%	347.2	124.7	109.3	611.2	263.3	6.3	4,875.7	-	2.34	-	43.6	67.2	
Mar-19	31	75%	58%	276.3	96.9	85.0	458.2	208.9	-	3,797.1	-	2.43	-	44.5	66.7	
Apr-19	30	44%	42%	54.2	19.2	16.8	90.2	41.3	-	713.0	-	2.49	-	49.1	65.5	
May-19	31	100%	100%	26.2	9.4	8.0	43.7	19.8	-	428.7	66.2	3.25	12.3	52.9	70.4	
Jun-19	30	100%	100%	25.4	7.5	9.6	42.5	23.9	-	-	576.4	-	13.5	63.7	76.3	
Jul-19	31	100%	100%	74.3	19.8	26.3	120.5	66.3	-	-	1,582.9	-	13.1	70.1	80.2	
Aug-19	31	100%	100%	52.0	13.5	18.5	83.9	46.3	-	-	1,109.8	-	13.2	69.4	78.2	
Sep-19	30	100%	100%	6.7	2.0	2.5	11.2	6.2	-	-	149.4	-	13.2	65.1	75.7	
Oct-19	31	100%	99%	23.1	7.9	7.0	37.9	17.1	-	318.6	51.5	2.73	13.6	58.6	69.0	
Nov-19	30	99%	98%	166.2	61.2	52.3	279.7	128.4	-	2,545.1	-	2.67	-	50.6	63.5	
Dec-19	31	99%	99%	214.1	81.9	69.8	365.8	171.8	-	3,393.6	-	2.72	-	46.8	60.7	
2018	365			1,713	559	419	2,690	1,297	-	24,656	4,987	2.51	12.7			
2019	365			1,705	594	512	2,840	1,321	6.3	22,214	3,536	2.55	13.2			
2018-2019	365			1,864	633	515	3,043	1,450	6	22,878	5,068	2.55	12.8	Winter	65.5	
														Summer	75.1	

Notes: **Bold** values based on cumulative monthly readings. Indoor temperatures imply home was absent for some months.

**Table 14. Monthly Energy Use, Loads and Efficiencies for HP Unit 6**

2	Unit 6													Loop Supply Temp (F)	Indoor Temp (F)
	No of Days	Good Records (Btu Mtr)	Good Records (Exp Brd)	Compressor Power (kWh)	Fan Power (kWh)	Pump Power (kWh)	Total Power (kWh)	Comp Runtime (hrs)	Electric Element Runtime (hrs)	Heating Load (MBtu)	Cooling Load (MBtu)	Net Heating COP (-)	Cooling EER (Btu/Wh)		
Jan-18	31	87%	77%	-	-	-	-	-	-	-	-	-	-	39.6	68.6
Feb-18	28	95%	93%	-	-	-	-	-	-	-	-	-	-	43.3	69.4
Mar-18	31	97%	94%	<b>414.1</b>	<b>81.3</b>	<b>93.9</b>	<b>731.9</b>	<b>252.7</b>	<b>29.7</b>	<b>5,532.8</b>	-	<b>2.22</b>	-	43.5	69.3
Apr-18	30	94%	91%	<b>232.4</b>	<b>47.0</b>	<b>52.3</b>	<b>391.6</b>	<b>141.4</b>	<b>12.5</b>	<b>3,045.8</b>	-	<b>2.28</b>	-	46.3	69.9
May-18	31	99%	98%	<b>25.4</b>	<b>8.2</b>	<b>6.1</b>	<b>40.7</b>	<b>16.8</b>	<b>0.2</b>	<b>387.1</b>	<b>252.8</b>	<b>6.25</b>	<b>11.8</b>	59.5	73.6
Jun-18	30	99%	98%	<b>43.0</b>	<b>8.2</b>	<b>13.3</b>	<b>64.5</b>	<b>37.0</b>	-	-	<b>822.6</b>	-	<b>12.9</b>	68.1	74.4
Jul-18	31	91%	90%	<b>196.7</b>	<b>32.7</b>	<b>57.0</b>	<b>286.3</b>	<b>158.5</b>	-	-	<b>3,263.2</b>	-	<b>12.1</b>	75.0	77.0
Aug-18	31	97%	96%	<b>259.4</b>	<b>43.7</b>	<b>74.2</b>	<b>377.3</b>	<b>207.2</b>	-	-	<b>4,156.6</b>	-	<b>11.8</b>	76.6	76.5
Sep-18	30	95%	94%	<b>78.8</b>	<b>19.4</b>	<b>20.3</b>	<b>118.5</b>	<b>56.5</b>	-	-	<b>1,301.9</b>	-	<b>11.1</b>	74.1	74.7
Oct-18	31	92%	91%	<b>166.6</b>	<b>32.9</b>	<b>35.5</b>	<b>244.4</b>	<b>95.8</b>	<b>2.0</b>	<b>2,052.9</b>	<b>0.7</b>	<b>2.47</b>	-	61.6	73.8
Nov-18	30	88%	85%	<b>454.0</b>	<b>87.4</b>	<b>103.5</b>	<b>667.7</b>	<b>281.8</b>	<b>4.7</b>	<b>5,659.7</b>	-	<b>2.48</b>	-	50.6	71.6
Dec-18	31	85%	79%	<b>632.0</b>	<b>123.6</b>	<b>143.2</b>	<b>957.6</b>	<b>388.6</b>	<b>12.2</b>	<b>7,921.3</b>	-	<b>2.42</b>	-	47.0	70.8
Jan-19	31	75%	62%	<b>650.6</b>	<b>132.6</b>	<b>152.2</b>	<b>1,042.5</b>	<b>401.7</b>	<b>22.3</b>	<b>8,405.5</b>	-	<b>2.36</b>	-	44.5	69.8
Feb-19	28	72%	53%	<b>541.1</b>	<b>112.2</b>	<b>122.2</b>	<b>837.9</b>	<b>333.5</b>	<b>13.0</b>	<b>6,797.1</b>	-	<b>2.38</b>	-	43.3	69.6
Mar-19	31	74%	57%	<b>494.9</b>	<b>102.3</b>	<b>110.6</b>	<b>789.5</b>	<b>298.6</b>	<b>17.0</b>	<b>6,205.3</b>	-	<b>2.30</b>	-	44.4	70.0
Apr-19	30	47%	44%	<b>148.4</b>	<b>31.3</b>	<b>33.0</b>	<b>215.2</b>	<b>89.2</b>	<b>0.5</b>	<b>1,277.1</b>	-	<b>2.48</b>	-	49.1	70.8
May-19	31	100%	100%	<b>74.3</b>	<b>16.2</b>	<b>17.9</b>	<b>108.5</b>	<b>48.6</b>	-	<b>963.9</b>	<b>188.3</b>	<b>3.06</b>	<b>12.1</b>	53.9	73.4
Jun-19	30	100%	100%	<b>18.5</b>	<b>4.9</b>	<b>5.4</b>	<b>28.8</b>	<b>15.0</b>	-	<b>151.5</b>	<b>360.9</b>	-	<b>13.0</b>	67.9	76.5
Jul-19	31	100%	100%	<b>307.8</b>	<b>71.4</b>	<b>81.9</b>	<b>461.0</b>	<b>228.2</b>	-	-	<b>5,605.0</b>	-	<b>12.2</b>	69.8	79.1
Aug-19	31	100%	100%	<b>180.7</b>	<b>44.5</b>	<b>46.6</b>	<b>271.8</b>	<b>129.2</b>	-	-	<b>3,158.0</b>	-	<b>11.6</b>	70.4	75.5
Sep-19	30	100%	100%	<b>27.9</b>	<b>7.0</b>	<b>8.2</b>	<b>43.2</b>	<b>22.7</b>	-	-	<b>532.8</b>	-	<b>12.7</b>	67.7	73.6
Oct-19	31	98%	99%	<b>11.6</b>	<b>3.6</b>	<b>3.2</b>	<b>18.3</b>	<b>8.7</b>	-	<b>66.5</b>	<b>144.6</b>	-	<b>13.6</b>	58.9	71.1
Nov-19	30	99%	98%	<b>403.5</b>	<b>81.2</b>	<b>91.6</b>	<b>582.4</b>	<b>248.1</b>	<b>1.3</b>	<b>5,073.1</b>	-	<b>2.55</b>	-	50.9	69.5
Dec-19	31	99%	98%	<b>577.3</b>	<b>115.7</b>	<b>133.4</b>	<b>842.4</b>	<b>361.7</b>	<b>3.3</b>	<b>7,150.9</b>	-	<b>2.49</b>	-	46.8	69.2
2018	365			2,503	484	599	3,880	1,636	61.3	24,600	9,798	2.44	11.9		
2019	365			3,437	723	806	5,242	2,185	57.4	36,091	9,990	2.41	12.1		
2018-2019	365			3,715	739	875	5,674	2,375	72	39,434	9,272	2.40	11.9	Winter	70.3
														Summer	75.6

Notes: **Bold** values based on cumulative monthly readings

**Table 15. Monthly Energy Use, Loads and Efficiencies for HP Unit 7**

2	Unit 7													Loop Supply Temp (F)	Indoor Temp (F)
	No of Days	Good Records (Btu Mtr)	Good Records (Exp Brd)	Compressor Power (kWh)	Fan Power (kWh)	Pump Power (kWh)	Total Power (kWh)	Comp Runtime (hrs)	Electric Element Runtime (hrs)	Heating Load (MBtu)	Cooling Load (MBtu)	Net Heating COP (-)	Cooling EER (Btu/Wh)		
Jan-18	31	88%	79%	-	-	-	-	-	-	-	-	-	-	40.2	64.7
Feb-18	28	94%	92%	-	-	-	-	-	-	-	-	-	-	43.7	61.7
Mar-18	31	95%	93%	<b>364.4</b>	<b>50.1</b>	<b>80.4</b>	<b>494.9</b>	<b>245.3</b>	-	<b>5,723.6</b>	-	<b>3.39</b>	-	44.0	63.9
Apr-18	30	93%	91%	<b>238.8</b>	<b>33.2</b>	<b>51.3</b>	<b>323.4</b>	<b>157.3</b>	-	<b>3,779.8</b>	-	<b>3.43</b>	-	47.1	66.0
May-18	31	98%	97%	<b>8.8</b>	<b>3.0</b>	<b>2.1</b>	<b>14.0</b>	<b>6.7</b>	-	100.2	96.4	-	15.8	60.0	71.3
Jun-18	30	98%	98%	<b>24.0</b>	<b>5.4</b>	<b>6.1</b>	<b>35.5</b>	<b>19.4</b>	-	-	561.9	-	15.4	68.2	74.5
Jul-18	31	87%	83%	<b>149.3</b>	<b>23.0</b>	<b>36.5</b>	<b>208.9</b>	<b>116.2</b>	-	-	3,077.9	-	15.5	74.7	77.8
Aug-18	31	95%	94%	<b>256.9</b>	<b>39.4</b>	<b>56.8</b>	<b>353.2</b>	<b>183.2</b>	-	-	4,833.9	-	14.8	76.7	76.8
Sep-18	30	91%	87%	<b>87.1</b>	<b>14.9</b>	<b>19.3</b>	<b>121.3</b>	<b>61.8</b>	-	-	1,798.4	-	14.8	74.9	75.8
Oct-18	31	88%	82%	<b>84.2</b>	<b>12.2</b>	<b>18.3</b>	<b>114.7</b>	<b>56.0</b>	-	1,339.4	154.2	3.74	14.8	62.3	70.1
Nov-18	30	79%	67%	<b>265.8</b>	<b>34.3</b>	<b>57.7</b>	<b>357.8</b>	<b>179.9</b>	-	4,414.3	-	3.61	-	51.1	66.3
Dec-18	31	72%	56%	<b>348.6</b>	<b>45.0</b>	<b>78.1</b>	<b>471.7</b>	<b>242.8</b>	-	5,767.2	-	3.58	-	47.4	62.7
Jan-19	31	62%	41%	<b>507.2</b>	<b>66.0</b>	<b>112.6</b>	<b>685.7</b>	<b>350.9</b>	-	<b>8,103.3</b>	-	<b>3.46</b>	-	45.3	64.5
Feb-19	28	58%	31%	<b>435.8</b>	<b>55.9</b>	<b>96.8</b>	<b>588.5</b>	<b>299.6</b>	-	<b>6,800.0</b>	-	<b>3.39</b>	-	43.8	64.6
Mar-19	31	61%	36%	<b>362.8</b>	<b>47.4</b>	<b>80.7</b>	<b>491.0</b>	<b>248.2</b>	-	<b>5,719.9</b>	-	<b>3.41</b>	-	45.1	65.6
Apr-19	30	72%	54%	<b>90.8</b>	<b>13.6</b>	<b>20.6</b>	<b>125.0</b>	<b>63.3</b>	-	1,547.8	-	3.63	-	51.0	64.0
May-19	31	100%	100%	<b>30.2</b>	<b>5.8</b>	<b>6.7</b>	<b>42.7</b>	<b>20.6</b>	-	545.8	-	3.68	-	56.9	67.6
Jun-19	30	100%	100%	<b>45.4</b>	<b>9.7</b>	<b>10.6</b>	<b>65.8</b>	<b>34.1</b>	-	1.0	1,059.4	-	16.0	66.0	73.5
Jul-19	31	100%	100%	<b>273.4</b>	<b>47.6</b>	<b>59.6</b>	<b>380.6</b>	<b>192.6</b>	-	-	5,998.1	-	15.7	69.7	77.0
Aug-19	31	100%	100%	<b>245.3</b>	<b>44.0</b>	<b>53.0</b>	<b>342.3</b>	<b>170.1</b>	-	-	5,157.6	-	15.0	70.0	74.2
Sep-19	30	100%	100%	<b>52.2</b>	<b>10.4</b>	<b>13.1</b>	<b>75.6</b>	<b>41.8</b>	-	-	1,220.7	-	16.0	67.1	73.3
Oct-19	31	99%	97%	<b>43.0</b>	<b>7.9</b>	<b>9.1</b>	<b>60.0</b>	<b>28.3</b>	-	566.3	233.6	3.91	15.1	58.8	68.4
Nov-19	30	97%	96%	<b>283.3</b>	<b>37.9</b>	<b>62.2</b>	<b>383.4</b>	<b>192.3</b>	-	4,847.5	-	3.70	-	50.8	64.6
Dec-19	31	98%	98%	<b>435.3</b>	<b>56.9</b>	<b>95.1</b>	<b>587.3</b>	<b>294.5</b>	-	<b>7,174.0</b>	-	<b>3.58</b>	-	47.1	64.3
2018	365			1,828	261	407	2,495	1,269	-	21,125	10,523	3.50	15.0		
2019	365			2,805	403	620	3,828	1,936	-	35,306	13,669	3.51	15.5		
2018-2019	365			2,664	367	595	3,626	1,857	-	34,239	10,924	3.50	15.1	Winter	64.8
														Summer	74.3

Notes: **Bold** values based on cumulative monthly readings

**Table 16. Monthly Energy Use, Loads and Efficiencies for HP Unit 8**

2	Unit 8														Loop Supply Temp (F)	Indoor Temp (F)
	No of Days	Good Records (Btu Mtr)	Good Records (Exp Brd)	Compressor Power (kWh)	Fan Power (kWh)	Pump Power (kWh)	Total Power (kWh)	Comp Runtime (hrs)	Electric Element Runtime (hrs)	Heating Load (MBtu)	Cooling Load (MBtu)	Net Heating COP (-)	Cooling EER (Btu/Wh)			
Jan-18	31	89%	84%	-	-	-	-	-	-	-	-	-	-	39.7	67.2	
Feb-18	28	95%	94%	-	-	-	-	-	-	-	-	-	-	43.3	67.5	
Mar-18	31	97%	95%	<b>489.9</b>	<b>84.7</b>	<b>115.0</b>	<b>690.6</b>	<b>343.4</b>	<b>0.2</b>	<b>6,463.4</b>	-	<b>2.74</b>	-	43.5	64.2	
Apr-18	30	94%	91%	<b>403.2</b>	<b>71.0</b>	<b>87.3</b>	<b>561.5</b>	<b>262.7</b>	-	<b>5,169.9</b>	-	<b>2.70</b>	-	46.7	69.0	
May-18	31	99%	98%	<b>27.7</b>	<b>6.6</b>	<b>6.9</b>	<b>41.2</b>	<b>21.2</b>	-	<b>52.9</b>	<b>426.4</b>	-	<b>12.0</b>	59.9	69.2	
Jun-18	30	100%	100%	<b>164.5</b>	<b>37.3</b>	<b>37.0</b>	<b>238.7</b>	<b>113.9</b>	-	-	<b>2,624.3</b>	-	<b>11.0</b>	67.7	69.6	
Jul-18	31	99%	99%	<b>89.3</b>	<b>18.4</b>	<b>20.6</b>	<b>128.3</b>	<b>64.4</b>	-	-	<b>1,427.5</b>	-	<b>11.2</b>	75.7	79.0	
Aug-18	31	100%	100%	<b>44.0</b>	<b>25.0</b>	<b>8.2</b>	<b>77.1</b>	<b>25.6</b>	-	-	<b>660.8</b>	-	<b>8.6</b>	77.6	81.1	
Sep-18	30	100%	100%	<b>58.4</b>	<b>15.8</b>	<b>12.1</b>	<b>86.3</b>	<b>37.4</b>	-	-	<b>866.3</b>	-	<b>10.2</b>	74.8	75.1	
Oct-18	31	98%	96%	<b>70.0</b>	<b>12.8</b>	<b>16.5</b>	<b>99.2</b>	<b>49.2</b>	-	<b>871.9</b>	<b>3.0</b>	<b>2.60</b>	<b>30.0</b>	62.1	67.9	
Nov-18	30	90%	85%	<b>385.5</b>	<b>67.8</b>	<b>83.8</b>	<b>537.1</b>	<b>256.2</b>	-	<b>4,251.2</b>	-	<b>2.71</b>	-	50.8	66.8	
Dec-18	31	83%	75%	<b>339.0</b>	<b>64.4</b>	<b>85.6</b>	<b>489.1</b>	<b>261.3</b>	-	<b>5,159.6</b>	-	<b>3.09</b>	-	46.9	58.7	
Jan-19	31	61%	44%	<b>754.6</b>	<b>141.8</b>	<b>155.5</b>	<b>1,093.7</b>	<b>476.1</b>	<b>8.7</b>	<b>10,490.2</b>	-	<b>2.81</b>	-	45.7	62.7	
Feb-19	28	42%	19%	<b>797.3</b>	<b>151.0</b>	<b>156.0</b>	<b>1,223.2</b>	<b>474.6</b>	<b>24.7</b>	<b>10,918.2</b>	-	<b>2.62</b>	-	44.4	66.9	
Mar-19	31	48%	28%	<b>686.4</b>	<b>133.3</b>	<b>139.5</b>	<b>1,047.7</b>	<b>421.3</b>	<b>18.4</b>	<b>9,423.4</b>	-	<b>2.64</b>	-	45.8	62.7	
Apr-19	30	84%	74%	<b>45.2</b>	<b>10.2</b>	<b>11.9</b>	<b>67.3</b>	<b>36.1</b>	-	<b>370.2</b>	-	<b>2.95</b>	-	49.9	60.8	
May-19	31	93%	88%	-	<b>1.0</b>	-	<b>1.0</b>	-	-	<b>3.1</b>	-	-	-	56.4	65.8	
Jun-19	30	97%	95%	-	<b>1.0</b>	-	<b>1.0</b>	-	-	<b>3.0</b>	-	-	-	67.9	74.4	
Jul-19	31	98%	97%	<b>307.1</b>	<b>78.5</b>	<b>61.2</b>	<b>446.8</b>	<b>194.9</b>	-	<b>65.2</b>	<b>4,950.5</b>	-	<b>11.1</b>	68.9	76.6	
Aug-19	31	98%	97%	<b>165.0</b>	<b>39.5</b>	<b>35.0</b>	<b>239.5</b>	<b>111.2</b>	-	-	<b>2,639.0</b>	-	<b>11.0</b>	69.8	75.5	
Sep-19	30	95%	92%	<b>13.9</b>	<b>3.4</b>	<b>4.0</b>	<b>21.3</b>	<b>12.3</b>	-	-	<b>259.2</b>	-	<b>12.4</b>	68.7	72.9	
Oct-19	31	89%	82%	<b>8.7</b>	<b>3.4</b>	<b>1.7</b>	<b>13.8</b>	<b>5.4</b>	-	-	<b>127.8</b>	-	<b>10.9</b>	59.3	65.1	
Nov-19	30	70%	54%	<b>424.1</b>	<b>79.5</b>	<b>84.1</b>	<b>642.0</b>	<b>255.6</b>	<b>11.3</b>	<b>4,708.8</b>	-	<b>2.46</b>	-	51.1	63.9	
Dec-19	31	54%	31%	<b>402.4</b>	<b>79.4</b>	<b>102.3</b>	<b>584.1</b>	<b>310.2</b>	-	<b>5,910.5</b>	-	<b>2.96</b>	-	47.5	61.1	
2018	365			2,071	404	473	2,949	1,435	0.2	21,969	6,008	2.79	10.7			
2019	365			3,605	722	751	5,382	2,298	63.2	41,893	7,977	2.70	11.1			
2018-2019	365			3,270	642	690	4,851	2,102	52	41,491	2,958	2.74	10.4	Winter	63.6	
														Summer	75.1	

Notes: **Bold** values based on cumulative monthly readings. Indoor temperatures imply home was absent for some months.



**Table 17. Monthly Energy Use, Loads and Efficiencies for HP Unit 9**

2	Unit 9													Loop Supply Temp (F)	Indoor Temp (F)
	No of Days	Good Records (Btu Mtr)	Good Records (Exp Brd)	Compressor Power (kWh)	Fan Power (kWh)	Pump Power (kWh)	Total Power (kWh)	Comp Runtime (hrs)	Electric Element Runtime (hrs)	Heating Load (MBtu)	Cooling Load (MBtu)	Net Heating COP (-)	Cooling EER (Btu/Wh)		
Jan-18	31	88%	84%	-	-	-	-	-	-	-	-	-	-	39.3	66.9
Feb-18	28	94%	92%	-	-	-	-	-	-	-	-	-	-	43.2	67.8
Mar-18	31	96%	93%	<b>298.4</b>	<b>46.1</b>	<b>65.8</b>	<b>410.3</b>	<b>195.4</b>	-	<b>3,837.4</b>	-	<b>2.74</b>	-	43.2	67.5
Apr-18	30	93%	91%	<b>176.9</b>	<b>27.4</b>	<b>38.6</b>	<b>242.9</b>	<b>115.4</b>	-	<b>2,306.7</b>	-	<b>2.78</b>	-	46.1	68.3
May-18	31	98%	98%	<b>30.5</b>	<b>5.3</b>	<b>7.6</b>	<b>43.4</b>	<b>23.1</b>	-	182.0	336.9	-	13.5	58.6	72.5
Jun-18	30	100%	100%	<b>68.1</b>	<b>10.6</b>	<b>17.8</b>	<b>96.5</b>	<b>54.9</b>	-	-	1,259.5	-	13.0	67.3	72.1
Jul-18	31	98%	97%	<b>180.4</b>	<b>24.9</b>	<b>43.2</b>	<b>248.4</b>	<b>134.3</b>	-	-	3,073.8	-	12.4	74.5	73.3
Aug-18	31	100%	100%	<b>202.5</b>	<b>27.8</b>	<b>47.5</b>	<b>277.8</b>	<b>149.2</b>	-	-	3,398.7	-	12.2	75.7	73.5
Sep-18	30	99%	99%	<b>90.5</b>	<b>13.0</b>	<b>21.4</b>	<b>124.9</b>	<b>66.5</b>	-	-	1,518.5	-	12.1	74.5	72.8
Oct-18	31	95%	91%	<b>81.1</b>	<b>12.6</b>	<b>18.0</b>	<b>111.7</b>	<b>54.3</b>	-	804.5	462.0	3.07	13.2	61.1	70.6
Nov-18	30	86%	77%	<b>205.5</b>	<b>30.8</b>	<b>44.3</b>	<b>280.6</b>	<b>135.5</b>	-	2,796.4	-	2.92	-	50.9	69.3
Dec-18	31	77%	64%	<b>295.7</b>	<b>43.5</b>	<b>64.3</b>	<b>403.5</b>	<b>196.8</b>	-	<b>3,971.5</b>	-	<b>2.88</b>	-	47.4	68.7
Jan-19	31	54%	35%	<b>430.3</b>	<b>62.8</b>	<b>95.0</b>	<b>588.0</b>	<b>282.6</b>	-	<b>5,656.6</b>	-	<b>2.82</b>	-	46.4	69.2
Feb-19	28	38%	14%	<b>344.5</b>	<b>51.2</b>	<b>75.0</b>	<b>470.7</b>	<b>227.4</b>	-	<b>4,413.7</b>	-	<b>2.75</b>	-	44.5	69.1
Mar-19	31	43%	21%	<b>274.2</b>	<b>41.4</b>	<b>60.1</b>	<b>375.7</b>	<b>180.8</b>	-	<b>3,515.5</b>	-	<b>2.74</b>	-	45.8	68.8
Apr-19	30	80%	69%	<b>92.7</b>	<b>14.5</b>	<b>19.5</b>	<b>126.6</b>	<b>58.4</b>	-	1,236.5	-	2.87	-	50.4	69.9
May-19	31	91%	85%	<b>38.2</b>	<b>6.4</b>	<b>8.3</b>	<b>52.9</b>	<b>24.9</b>	-	528.4	-	2.94	-	55.1	72.3
Jun-19	30	97%	94%	<b>48.9</b>	<b>9.5</b>	<b>12.3</b>	<b>70.6</b>	<b>37.7</b>	-	149.2	938.9	-	13.4	64.3	72.7
Jul-19	31	98%	96%	<b>179.7</b>	<b>29.0</b>	<b>42.8</b>	<b>251.5</b>	<b>133.2</b>	-	-	3,200.2	-	12.7	69.4	72.9
Aug-19	31	98%	97%	<b>114.4</b>	<b>17.6</b>	<b>28.8</b>	<b>160.8</b>	<b>89.1</b>	-	-	2,059.0	-	12.8	69.5	73.4
Sep-19	30	91%	87%	<b>61.5</b>	<b>10.6</b>	<b>16.0</b>	<b>88.1</b>	<b>49.3</b>	-	-	1,151.2	-	13.1	67.1	72.4
Oct-19	31	82%	72%	<b>34.3</b>	<b>6.2</b>	<b>7.6</b>	<b>48.1</b>	<b>23.1</b>	-	351.9	195.4	3.08	13.6	59.1	70.5
Nov-19	30	59%	39%	<b>212.3</b>	<b>32.5</b>	<b>45.9</b>	<b>290.8</b>	<b>138.7</b>	-	2,363.0	-	2.93	-	51.6	69.4
Dec-19	31	43%	20%	<b>332.0</b>	<b>49.9</b>	<b>72.8</b>	<b>454.6</b>	<b>220.3</b>	-	<b>4,390.0</b>	-	<b>2.83</b>	-	48.1	69.0
2018	365			1,630	242	368	2,240	1,125	-	13,898	10,049	2.81	12.4		
2019	365			2,163	332	484	2,979	1,465	-	22,605	7,545	2.80	12.9		
2018-2019	365			2,284	338	509	3,132	1,548	-	23,072	9,392	2.81	12.4	Winter	69.0
														Summer	72.9

Notes: **Bold** values based on cumulative monthly readings

**Table 18. Monthly Energy Use, Loads and Efficiencies for HP Unit 10**

2	Unit 9													Loop Supply Temp (F)	Indoor Temp (F)
	No of Days	Good Records (Btu Mtr)	Good Records (Exp Brd)	Compressor Power (kWh)	Fan Power (kWh)	Pump Power (kWh)	Total Power (kWh)	Comp Runtime (hrs)	Electric Element Runtime (hrs)	Heating Load (MBtu)	Cooling Load (MBtu)	Net Heating COP (-)	Cooling EER (Btu/Wh)		
Jan-18	31	88%	84%	-	-	-	-	-	-	-	-	-	-	39.3	66.9
Feb-18	28	94%	92%	-	-	-	-	-	-	-	-	-	-	43.2	67.8
Mar-18	31	96%	93%	<b>298.4</b>	<b>46.1</b>	<b>65.8</b>	<b>410.3</b>	<b>195.4</b>	-	<b>3,837.4</b>	-	<b>2.74</b>	-	43.2	67.5
Apr-18	30	93%	91%	<b>176.9</b>	<b>27.4</b>	<b>38.6</b>	<b>242.9</b>	<b>115.4</b>	-	<b>2,306.7</b>	-	<b>2.78</b>	-	46.1	68.3
May-18	31	98%	98%	<b>30.5</b>	<b>5.3</b>	<b>7.6</b>	<b>43.4</b>	<b>23.1</b>	-	182.0	336.9	-	13.5	58.6	72.5
Jun-18	30	100%	100%	<b>68.1</b>	<b>10.6</b>	<b>17.8</b>	<b>96.5</b>	<b>54.9</b>	-	-	1,259.5	-	13.0	67.3	72.1
Jul-18	31	98%	97%	<b>180.4</b>	<b>24.9</b>	<b>43.2</b>	<b>248.4</b>	<b>134.3</b>	-	-	3,073.8	-	12.4	74.5	73.3
Aug-18	31	100%	100%	<b>202.5</b>	<b>27.8</b>	<b>47.5</b>	<b>277.8</b>	<b>149.2</b>	-	-	3,398.7	-	12.2	75.7	73.5
Sep-18	30	99%	99%	<b>90.5</b>	<b>13.0</b>	<b>21.4</b>	<b>124.9</b>	<b>66.5</b>	-	-	1,518.5	-	12.1	74.5	72.8
Oct-18	31	95%	91%	<b>81.1</b>	<b>12.6</b>	<b>18.0</b>	<b>111.7</b>	<b>54.3</b>	-	804.5	462.0	3.07	13.2	61.1	70.6
Nov-18	30	86%	77%	<b>205.5</b>	<b>30.8</b>	<b>44.3</b>	<b>280.6</b>	<b>135.5</b>	-	2,796.4	-	2.92	-	50.9	69.3
Dec-18	31	77%	64%	<b>295.7</b>	<b>43.5</b>	<b>64.3</b>	<b>403.5</b>	<b>196.8</b>	-	<b>3,971.5</b>	-	<b>2.88</b>	-	47.4	68.7
Jan-19	31	54%	35%	<b>430.3</b>	<b>62.8</b>	<b>95.0</b>	<b>588.0</b>	<b>282.6</b>	-	<b>5,656.6</b>	-	<b>2.82</b>	-	46.4	69.2
Feb-19	28	38%	14%	<b>344.5</b>	<b>51.2</b>	<b>75.0</b>	<b>470.7</b>	<b>227.4</b>	-	<b>4,413.7</b>	-	<b>2.75</b>	-	44.5	69.1
Mar-19	31	43%	21%	<b>274.2</b>	<b>41.4</b>	<b>60.1</b>	<b>375.7</b>	<b>180.8</b>	-	<b>3,515.5</b>	-	<b>2.74</b>	-	45.8	68.8
Apr-19	30	80%	69%	<b>92.7</b>	<b>14.5</b>	<b>19.5</b>	<b>126.6</b>	<b>58.4</b>	-	1,236.5	-	2.87	-	50.4	69.9
May-19	31	91%	85%	<b>38.2</b>	<b>6.4</b>	<b>8.3</b>	<b>52.9</b>	<b>24.9</b>	-	528.4	-	2.94	-	55.1	72.3
Jun-19	30	97%	94%	<b>48.9</b>	<b>9.5</b>	<b>12.3</b>	<b>70.6</b>	<b>37.7</b>	-	149.2	938.9	-	13.4	64.3	72.7
Jul-19	31	98%	96%	<b>179.7</b>	<b>29.0</b>	<b>42.8</b>	<b>251.5</b>	<b>133.2</b>	-	-	3,200.2	-	12.7	69.4	72.9
Aug-19	31	98%	97%	<b>114.4</b>	<b>17.6</b>	<b>28.8</b>	<b>160.8</b>	<b>89.1</b>	-	-	2,059.0	-	12.8	69.5	73.4
Sep-19	30	91%	87%	<b>61.5</b>	<b>10.6</b>	<b>16.0</b>	<b>88.1</b>	<b>49.3</b>	-	-	1,151.2	-	13.1	67.1	72.4
Oct-19	31	82%	72%	<b>34.3</b>	<b>6.2</b>	<b>7.6</b>	<b>48.1</b>	<b>23.1</b>	-	351.9	195.4	3.08	13.6	59.1	70.5
Nov-19	30	59%	39%	<b>212.3</b>	<b>32.5</b>	<b>45.9</b>	<b>290.8</b>	<b>138.7</b>	-	2,363.0	-	2.93	-	51.6	69.4
Dec-19	31	43%	20%	<b>332.0</b>	<b>49.9</b>	<b>72.8</b>	<b>454.6</b>	<b>220.3</b>	-	<b>4,390.0</b>	-	<b>2.83</b>	-	48.1	69.0
2018	365			1,630	242	368	2,240	1,125	-	13,898	10,049	2.81	12.4		
2019	365			2,163	332	484	2,979	1,465	-	22,605	7,545	2.80	12.9		
2018-2019	365			2,284	338	509	3,132	1,548	-	23,072	9,392	2.81	12.4	Winter	69.0
														Summer	72.9

Notes: **Bold** values based on cumulative monthly readings. Collection of electric data stopped in November and December 2019

## 4.2 Explaining Differences in Heat Pump Performance

### 4.2.1 Comparing High- and Low-Stage Heat Pump COP

We aggregated that data into hourly values and then identified intervals where each heat pump ran the entire hour (continuously) at full load conditions at high stage. Since the heat pumps are dual stage, we also identified hourly intervals where the heat pump ran continuously but was at a lower power level. These points were identified as continuous low stage operation. Figure 8 shows hourly data and specifically identifies the high- and low-stage operating points for HP1 and HP3. Figure 9 uses the hourly data to show the heating COP changes with heat pump output and also shows the high- and low-stage operating points.

The net heating COP at low stage, which in theory should be higher according to the AHRI-rated unit performance data in Table 3, is typically lower than or the same as the full load COP at high stage. This occurs because the loop pumps operate at the same flow regardless of compressor stage. Therefore, the net heating COP at low stage, which includes the same amount of pumping power at high stage, results in lower system COP. In summary, the single stage pumping combined with a dual stage heat pump unit actually results in a lower average COP than would occur for a single stage unit. Since the unit spends most of the operating hours at low-stage, the seasonal COP is strongly affected by this combination of single-stage pumping with a dual stage unit.

Figure 10 confirms the difference between high- and low-stage COPs by showing a few hours of operation on a cold day for HP7. While the COPs calculated at 5-minute intervals are somewhat scattered (due to the resolution of the power measurement), the COP does increase during the few minutes of high-stage operation around 6 am on this day.

Figure 8. Compressor Power vs. Runtime to Show Low- and High-Stage Operation: HP1 & HP3

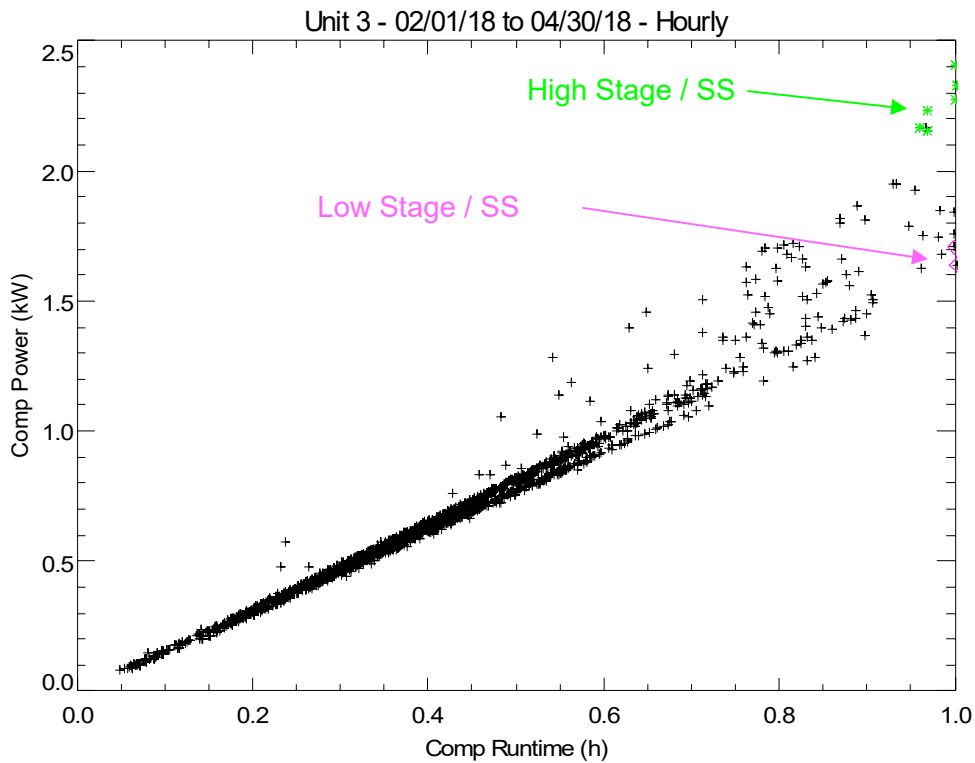
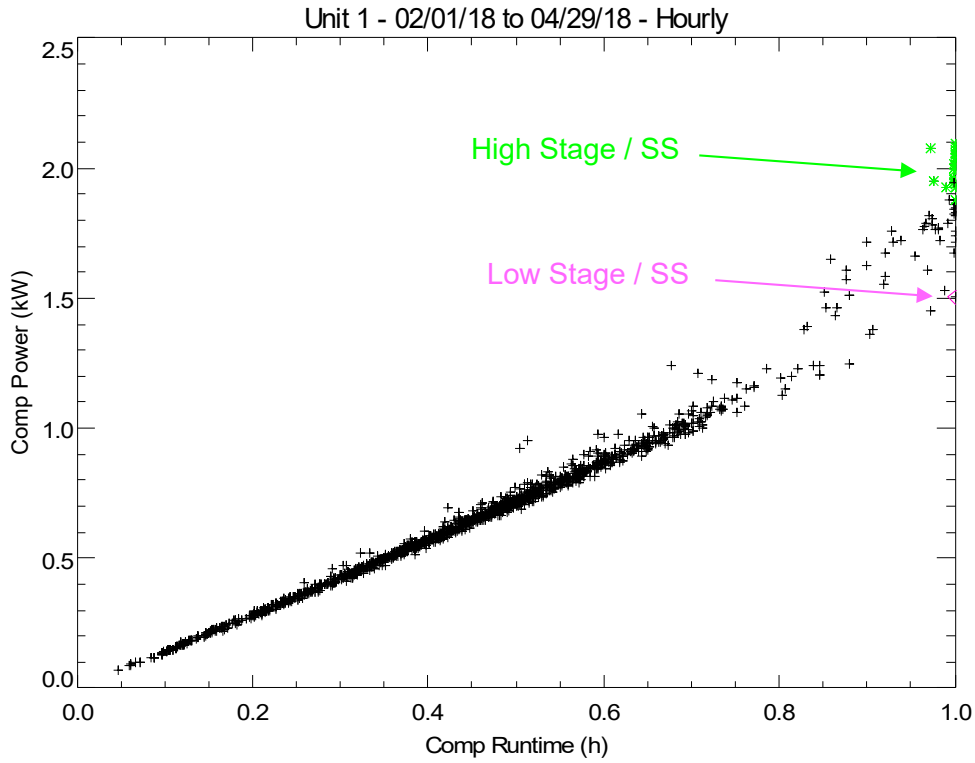
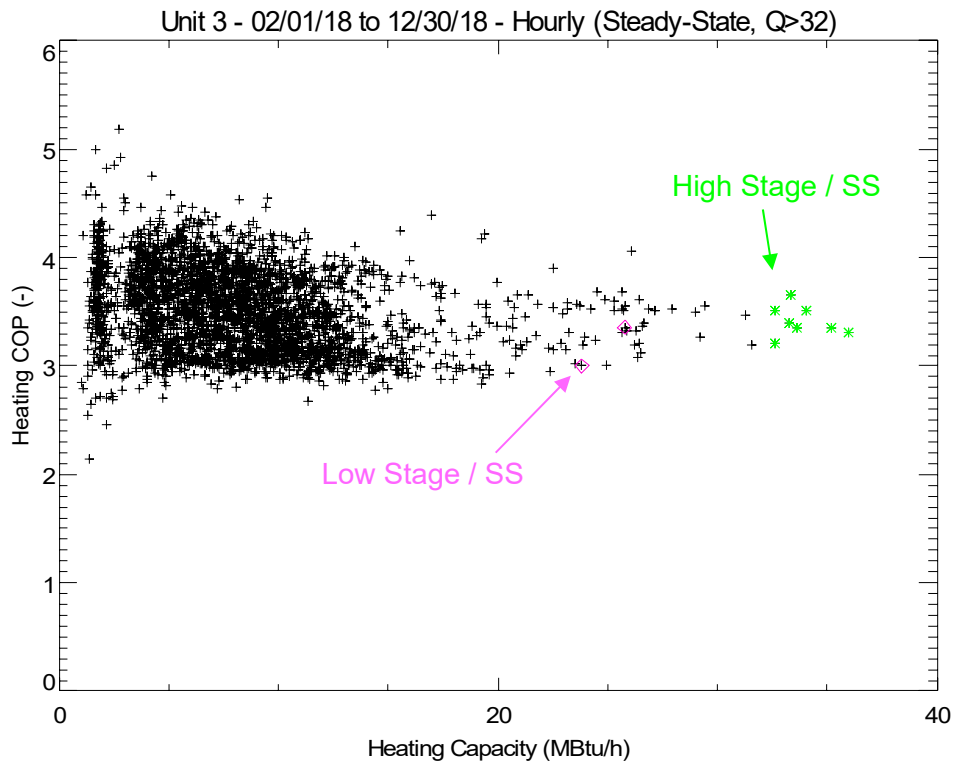
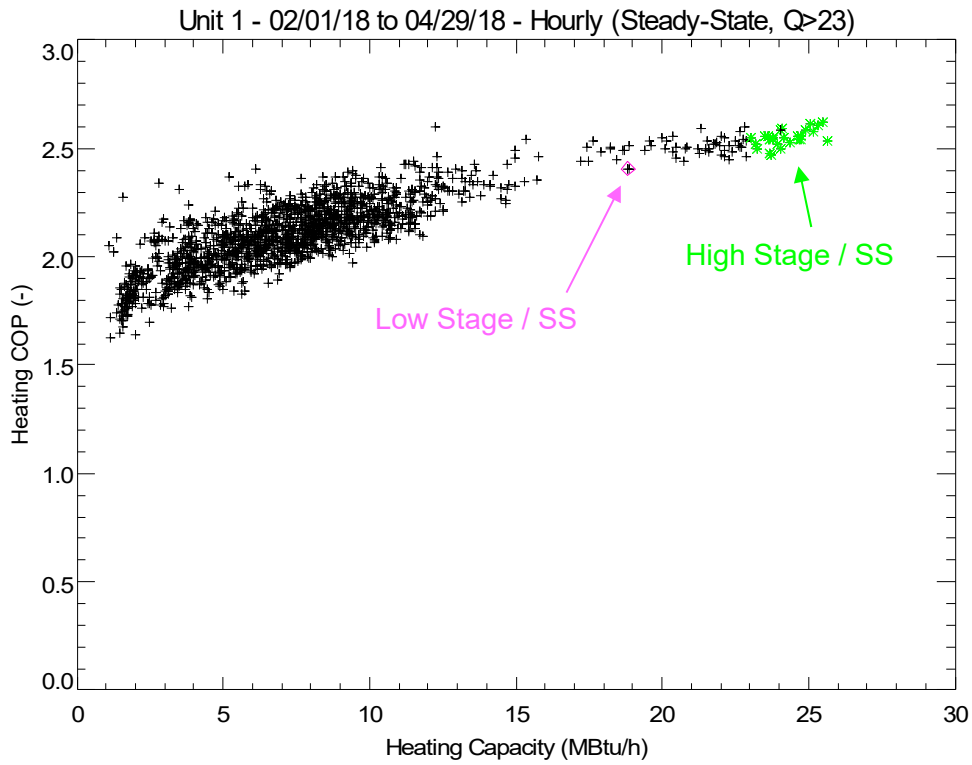
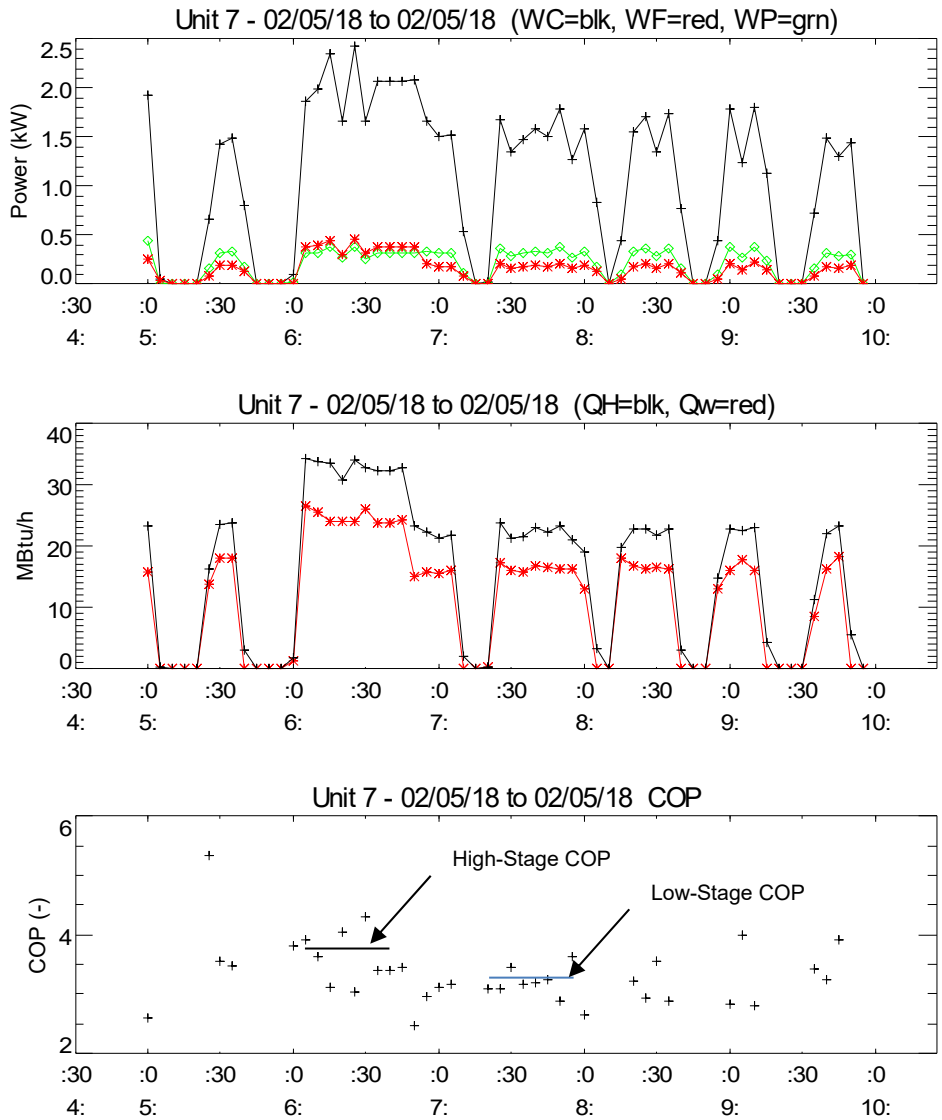


Figure 9. Heating COP vs Heating Output for HP1 & HP3



**Figure 10. A few Hour of Operation When HP7 goes into High Stage**



#### 4.2.2 Examining Peak Hour Heat Pump Performance

Table 19 below shows power, flow, and temperature data for the peak hour for each heat pump system. There is considerable variation in loop pumping power, loop flow rate, and fan power for each home. Loop flows vary from 6 to 11 gpm and pumping power varies from 155 to 407 Watts. Fan power ranges from 324 to 466 Watts, due to the differences in the existing ductwork and the actual airflows at each site. Notes that these values in the table were a snapshot for one hour. Appendix D shows that loop flows, pump power, and fan power at some sites did vary somewhat as settings were changed (or conditions varied) across the 24-month period.



**Table 19. Measured Performance at a Peak Hour of Heating Operation**

Unit	Date & Time		WC (kW)	WF (kW)	WP (kW)	FW (gpm)	TWS (F)	DT-Water (F)	TAS (F)	DT-Air (F)	QW (MBtu/h)	QH (MBtu/h)	SC (h)
1	3/20/2018	3:00:00	2.168	0.453	0.342	8.403	43.8	4.09	96.2	21.54	16.71	25.65	1.029
2	3/13/2018	11:00:00	2.188	0.324	0.407	9.322	40.4	4.49	98.3	24.30	20.51	29.08	0.999
3	3/13/2018	7:00:00	2.462	0.362	0.155	6.029	42.9	8.01	103.3	30.45	22.99	32.62	1.026
4	11/16/2019	23:00:00	1.778	0.35	0.317	8.634	49.3	5.17	101.3	27.47	21.79	29.05	0.998
5	2/3/2018	3:00:00	1.834	0.466	0.318	7.73	39.9	4.41	89.1	18.71	16.37	24.21	0.999
6	3/22/2018	6:00:00	2.032	0.428	0.37	10.962	41.8	3.30	90.8	19.80	16.84	25.24	1.002
7	2/5/2018	6:00:00	1.954	0.353	0.325	8.383	42.2	5.53	90.5	24.88	22.83	30.71	0.999
8	2/9/2018	8:00:00	2.008	0.35	0.332	8.364	39.8	4.41	90.0	22.61	18.04	26.08	0.998
9	2/14/2018	21:00:00	2.221	0.346	0.329	9.162	44.6	4.54	99.1	24.95	20.38	29.14	1.001
10	2/9/2018	7:00:00	2.072	0.37	0.165	8.051	39.2	4.95	92.2	21.98	19.36	27.69	1.003

Table 20 breaks out the data related to pumping. It compares the heating COP for this peak hour to the pump power and other loop related values. Units 1, 2 and 6 had the highest pump power (highlighted as red) and this showed some correspondence to the lowest COP (shaded rows). Figure 11 shows there is some indication that higher pumping power is related to low COP.

**Table 20. Pump Performance Metrics at Peak Heating Hour**

Unit	COP	WP	gpm	Loop Delta-T	W/gpm
1	2.5	342	8.4	4.1	40.7
2	2.9	407	9.3	4.5	43.7
3	3.2	155	6.0	8.0	25.7
4	3.5	317	8.6	5.2	36.7
5	2.7	318	7.7	4.4	41.1
6	2.6	370	11.0	3.3	33.8
7	3.4	325	8.4	5.5	38.8
8	2.8	332	8.4	4.4	39.7
9	2.9	329	9.2	4.5	35.9
10	3.1	165	8.1	5.0	20.5

Appendix D shows the variation of loop flow and pumping power across the entire monitoring period. The values in the tables above were a snapshot at one particular hour when the unit was in high-stage heating. The plots in Appendix D show that loop flows did vary as adjustments were made to some pumps over the period (particularly to units HP3, HP4 and HP5).

**Figure 11. Comparing Heating COP to Pumping Power for all HP Systems**

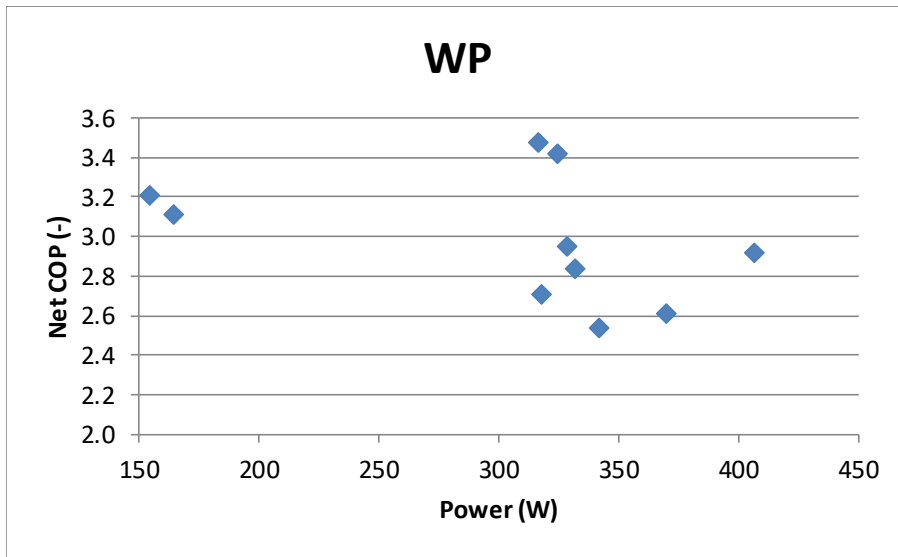
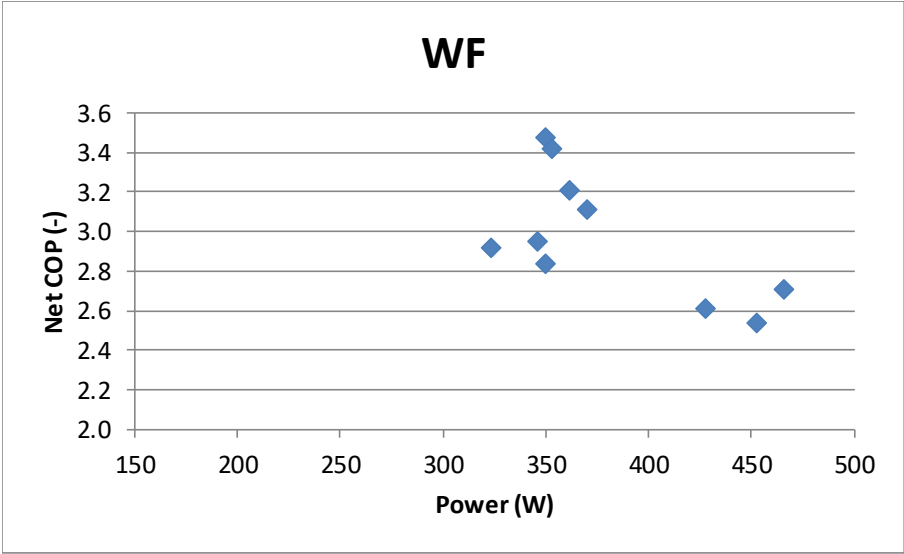


Table 21 compares the system COP for this peak hour to the fan power and airside data. The fan power for HP1, HP5 and HP6 was the highest, so those values are highlighted as red in the table. The shade rows in the table highlight the units with the 3 lowest COPs. Figure 12 shows there is some indication that higher fan power is related to lower COPs.

**Table 21. Fan Performance Metrics at Peak Heating Hour**

Unit	COP	WF	Air Delta-T	Implied cfm	W/cfm
1	2.5	453	21.5	1102	0.41
2	2.9	324	24.3	1108	0.29
3	3.2	362	30.4	992	0.36
4	3.5	350	27.5	979	0.36
5	2.7	466	18.7	1198	0.39
6	2.6	428	19.8	1180	0.36
7	3.4	353	24.9	1143	0.31
8	2.8	350	22.6	1068	0.33
9	2.9	346	24.9	1081	0.32
10	3.1	370	22.0	1167	0.32

Figure 12. Comparing Heating COP to Fan Power for all HP systems



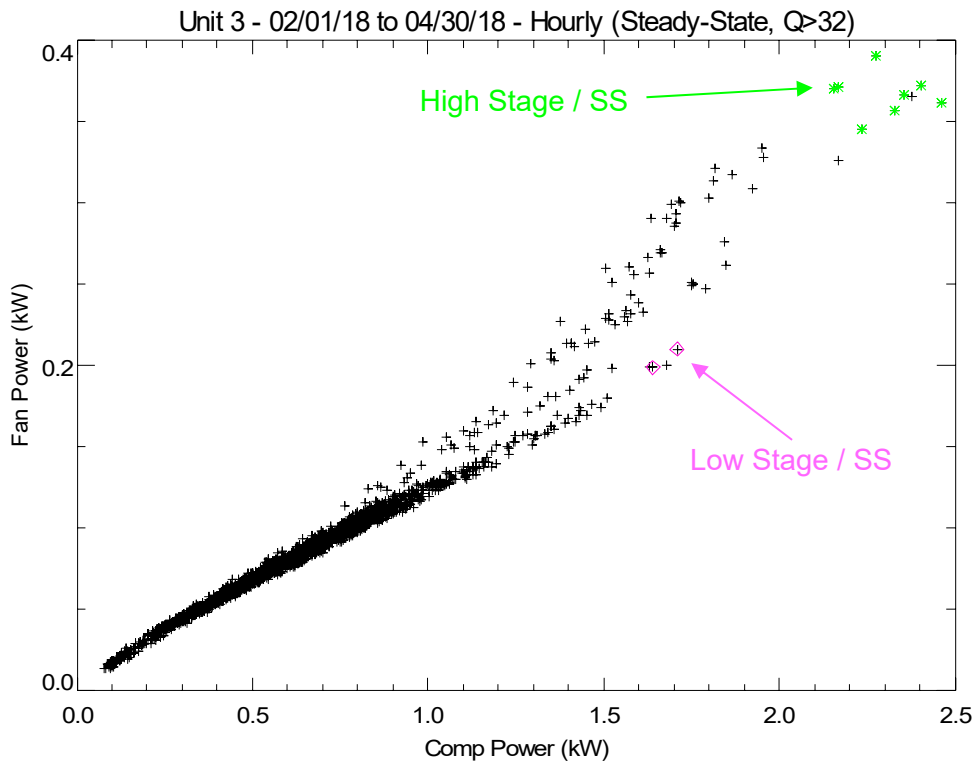
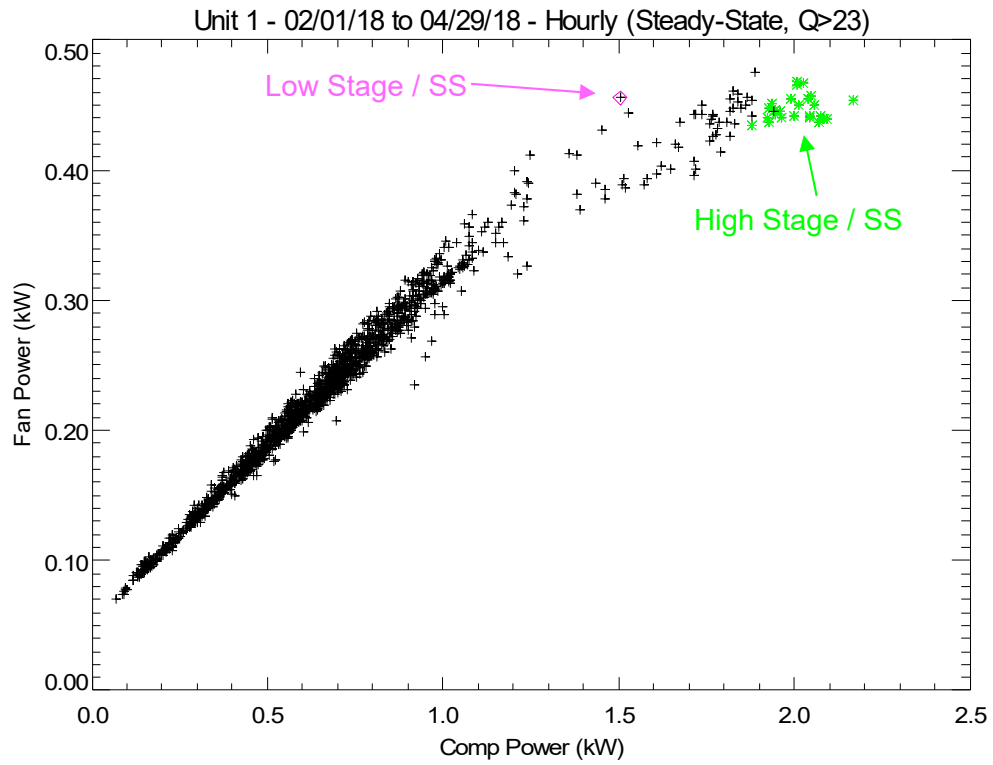
### 4.2.3 Differences in Dual Stage Fan Control

By looking at the hourly data we also observed differences between how the fan was controlled for the dual stage HP units. Figure 13 shows the trend of fan power with compressor power for HP1 and HP3. The high- and low-stage hourly intervals with continuous operation are identified. HP3 shows the expected performance trend, with low-stage compressor operation corresponding to a lower level of fan power (and a lower air flow rate). In contrast, HP1 shows that the fan power was at the same level for both low- and high-stage operation. This implies the airflow did not modulate with capacity as expected. Table 22 summarizes which HP systems demonstrated which operating pattern. HP1, HP2 and HP5 did not modulate airflow with compressor stage, which would be expected to lower the seasonal heating COP. HP4 never operated at high-stage, so we were not able to confirm if airflow modulation was staged.

**Table 22. Fan Power Difference Between Low-Stage and High-Stage Operation**

HP	Low Stage Fan (kW)	High Stage Fan (kW)	Fan Control
1	0.45	0.45	Same
2	0.33	0.33	Same
3	0.18	0.37	Staged
4	0.35	never observed	?
5	0.48	0.48	Same
6	0.25	0.42	Staged
7	0.20	0.35	Staged
8	0.20	0.35	Staged
9	0.20	0.35	Staged
10	0.18	0.33	Staged

Figure 13. Comparing Hourly Fan Power to Compressor Power for HP1 & HP3



#### 4.2.4 Summary of Observed Performance Differences

Table 23 summarizes the observed differences between the units and how these factors at least partially explain the differences in observed seasonal heating COPs. The observations are based on the issues discussed in this sub-section (pump power, fan power, fan modulation) as well as other issues apparent from the seasonal table (HP type, resistance element operation). The Packaged HPs had the highest COPs of 3.5 and 3.7. The Split unit COPs ranged from 2.2 to 3.0.

**Table 23. Summary of Observed Differences Between GSHP Systems**

Unit	HP Type	Peak Heating COP	Net Seasonal Heating COP	Observations
1	Split	2.5	2.2	Fan power is high, pump power is high, fan power does not modulate with compressor stage
2	Split	2.9	2.9	Pump power is high, fan power does not modulate with stage. Very little high stage operation.
3	<b>Packaged</b>	<b>3.2</b>	<b>3.7</b>	<b>Packaged unit has higher COP. Loop flow is only 6 gpm and pump power is lower, so COP is higher</b>
4	Split	3.5	2.5	Unit oversized, so it cycles frequently (peak COP is 3.5, seasonal COP is 2.5). No heating operation at high stage.
5	Split	2.7	2.6	Fan power is high, fan power does not modulate with stage.
6	Split	2.6	2.4	Fan power is high, pump power is high, aux resistance heat comes on occasionally on coldest days
7	<b>Packaged</b>	<b>3.4</b>	<b>3.5</b>	<b>Packaged unit has higher COP</b>
8	Split	2.8	2.7	
9	Split	2.9	2.8	
10	Split	3.1	3.0	

Notes: Rated COPs (from Table 2) for Packaged units are 10-14% higher than Split units. Peak COP is from Table 20. Seasonal COPs are from Table 8.



### 4.3 Ground Loop Temperatures

Figure 14 shows the hourly ground loop temperatures for the entire 24-month period when the heat pump(s) operated. The supply temperature from the loop (TWS) is shown as a black line while the return temperature to the loop (TWR) is shown as red. Temperatures are shown for HP3 since they were available for the entire period. Data for the main loop temperatures started on June 20, 2018 and are shown with thicker lines. The loop design temperatures are also shown on the plot as horizontal dotted lines. The loop was sized to have a maximum entering water temperature ( $TWS_{max}$ ) of 80°F in the summer and a minimum entering water temperature ( $TWS_{min}$ ) of 37°F (these design details are taken from Figure 5).

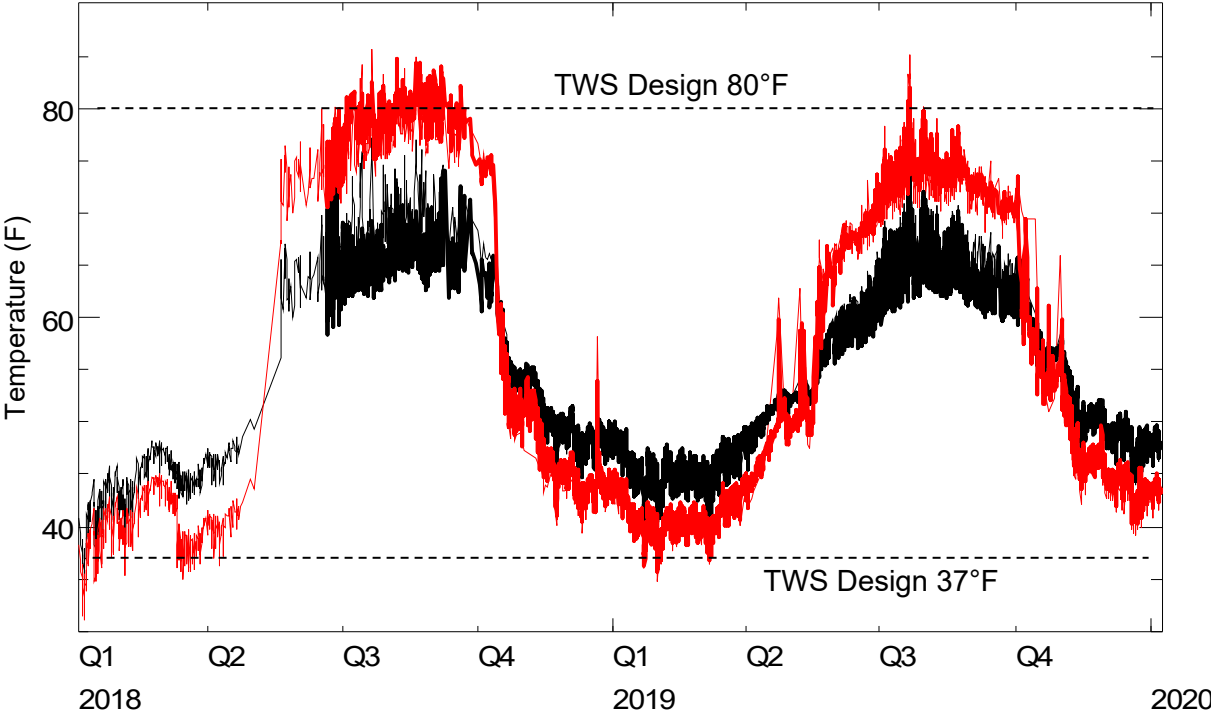
The long-term temperature profile shows the expected performance trends:

- The supply temperature is about 5-6°F warmer than the return in the winter when the system is extracting heat from the loop
- The supply temperature is about 8-10°F lower than the return in the summer when the system is rejecting heat to the earth
- The loop temperatures settled into a seasonal pattern after about the first year of operation. The supply temperatures at the end of 2019 were similar to temperatures at the end of the previous year.

The loop supply temperatures were slightly higher in the summer of 2018 compared to the summer of 2019.

Overall, the summertime loop supply temperatures were typically near 65°F and rarely exceeded 70°F – well below the design condition of 80°F. Similarly, the winter temperatures were typically around 45°F, well above the design point of 37°F.

Figure 14. Loop Supply (TWS) and Return (TWR) Temperatures (thick lines are Main Loop)



## 4.4 Ground Loop Load Diversity

To assess the level of load diversity on the ground loop, we compared the measured peak load imposed on the ground loop by each heat pump to the measured load imposed on the entire loop. Figure 15 shows the measured loads imposed on the ground loop by all the units for each hour. The peak heat rejection load imposed on the loop in an hour was 320 MBtu/h in July 2019. The peak hourly heat extraction load was 160 MBtu/h in early 2019 (note that these heat transfer rates are both expressed as absolute values).

**Figure 15. Plot of Hourly Loads Imposed on the Ground Loop**

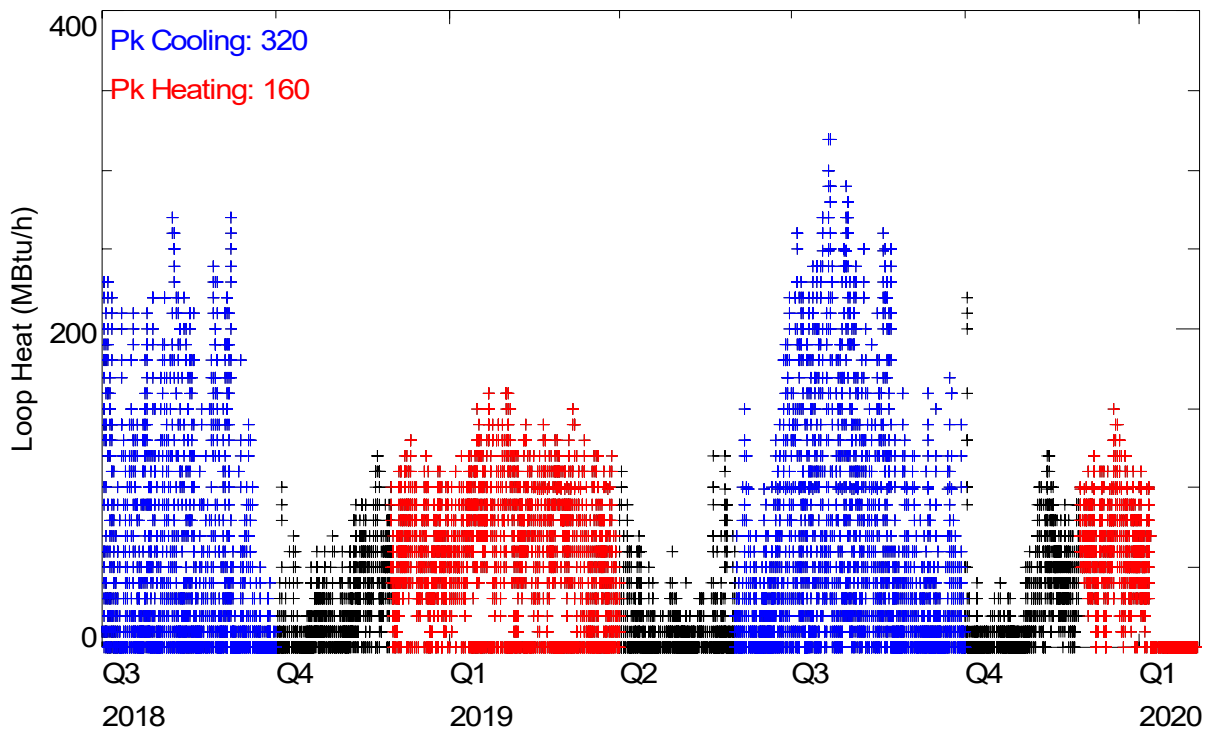


Table 24 compares these measured loop loads to the sum of the non-coincident loads imposed by each heat pump in both summer and winter. For reference the table also includes the maximum expected heat rejection (summer) and heat extraction (winter) based on the capacity and efficiency of each heat pump unit (these values are from the loop design report). The results show that the measured peak loop load in summer is about 85% of the sum of the (non-coincident) peak loads imposed by each heat pump. This coincidence factor is 82% in the winter.

**Table 24. Comparing Non-coincident HP Loop Loads to Total Loop Loads**

	Peak Load Imposed on Ground Loop (MBtu/h)			
	Summer Measured	Summer Expected	Winter Measured	Winter Expected
HP1	33	44.1	17	22.5
HP2	39	44.1	20	22.5
HP3 (XT packaged)	40	46.5	19	25.5
HP4	39	44.1	20	22.5
HP5	25	44.1	18	22.5
HP6	36	44.1	19	22.5
HP7 (XT packaged)	47	46.5	26	25.5
HP8	37	44.1	20	22.5
HP9	38	44.1	21	22.5
HP10	42	44.1	16	22.5
<b>Sum of all HPs</b>	<b>376</b>	<b>445.9</b>	<b>196</b>	<b>231.0</b>
Measured Ground Loop	320		160	
Coincidence Factor	85%	72%	82%	69%

Notes: Expected loop heat transfer rates based on heating capacity and efficiency for the installed units (RT unit: 30.9 Mtu/h and 3.68 COP; XT Unit: 33.4 MBtu/h and 4.2 COP) as well as the cooling capacity and efficiency: (RT Unit: 35.6 Btu/h and 14.27 EER; XT Unit: 38.3 and 15.93 EER)

The expected loop loads for each heat pump based on its capacity and efficiency are even larger than the measured loads for each heat pump. The sum of the expected loads is 18-19% larger than the sum of the measured loads for each heat pump. The coincidence factor comparing measured loop loads to the expected heat transfer based on the capacity and efficiency of each heat pump is 72% in summer and 69% in winter.

Overall, this result shows that even for community loops with similar homes – where very little load diversity might be expected – the peak loads imposed on the ground loop in any hour are 80% of simple sum of the individual loads and 70% of the expected equipment loads. This implies that future designs of community loops could take advantage of this peak load diversity and reduce the size of the ground heat exchanger by some amount. Since the loop design process considers both peak, monthly, and annual loads, the size reduction may be somewhat less than the 20 or 30% reduction in peak loads but should still be significant. If we assume loop size can be reduced by 15%, the reduction in loop field installed costs would be \$12,000 at this site.

## 4.5 Impact of Reversed Loop Piping

Figure 4 above shows the locations of all the houses and bores and Figure 6 schematically shows the loop piping. Figure 18 below shows the headering between the loop and the heat pumps during construction. Figure 16 and Figure 17 compare the main loop supply and return temperatures to the supply and return for each heat pump (green and red, respectively). Surprisingly, the supply temperatures for some of heat pumps are closer to the return than the supply.

**Figure 16. Comparing Main Loop TWS & TWR (lines) to HP TWS (green) and TWR (red) – HPs 1 to 4**

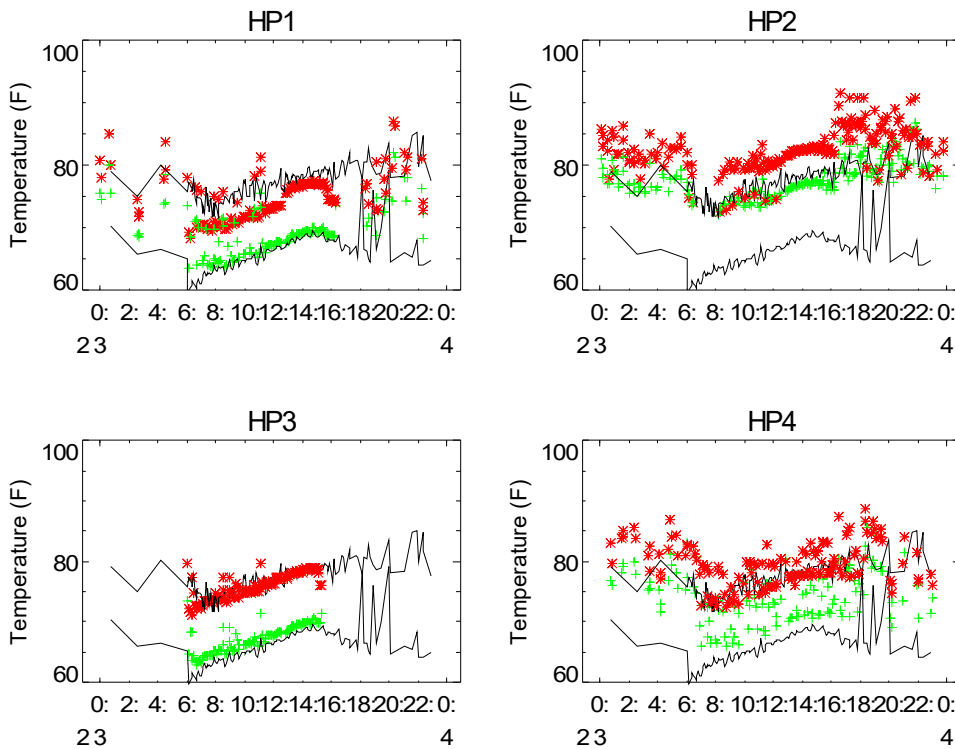


Figure 17. Comparing Main Loop TWS & TWR (lines) to HP TWS (green) and TWR (red) – HPs 5 to 10

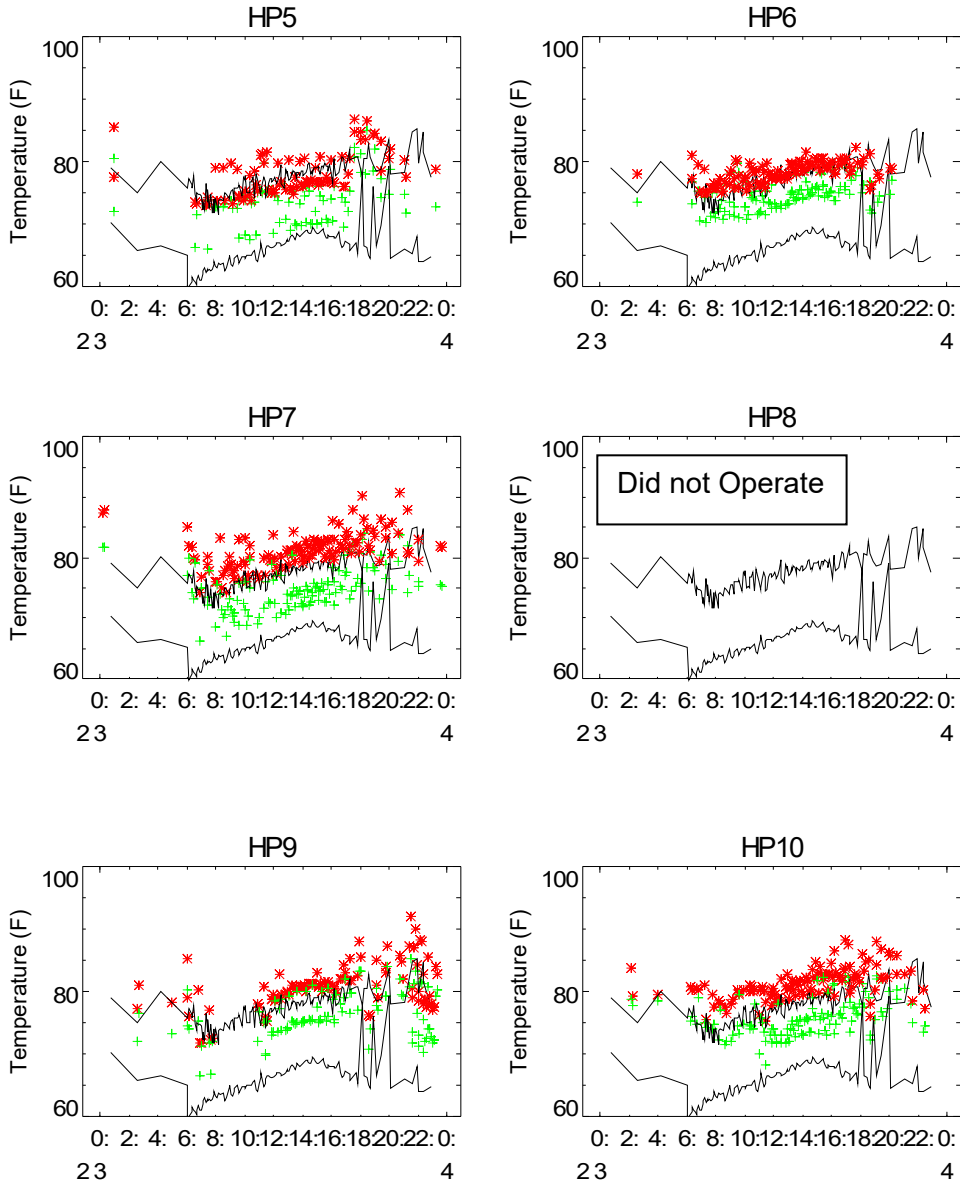
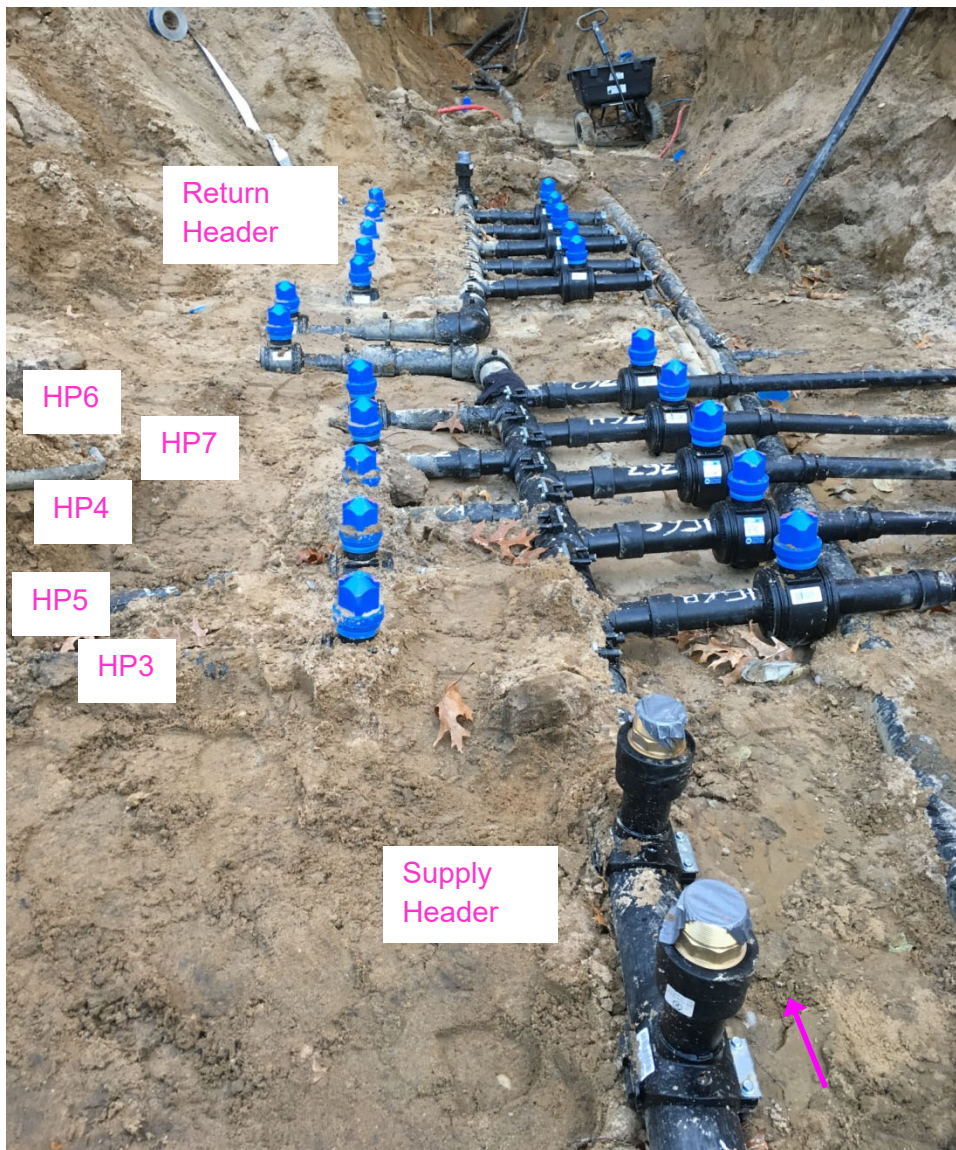




Figure 18. Photos Showing Header Details from Ground Loop Heat Exchanger to Each HP

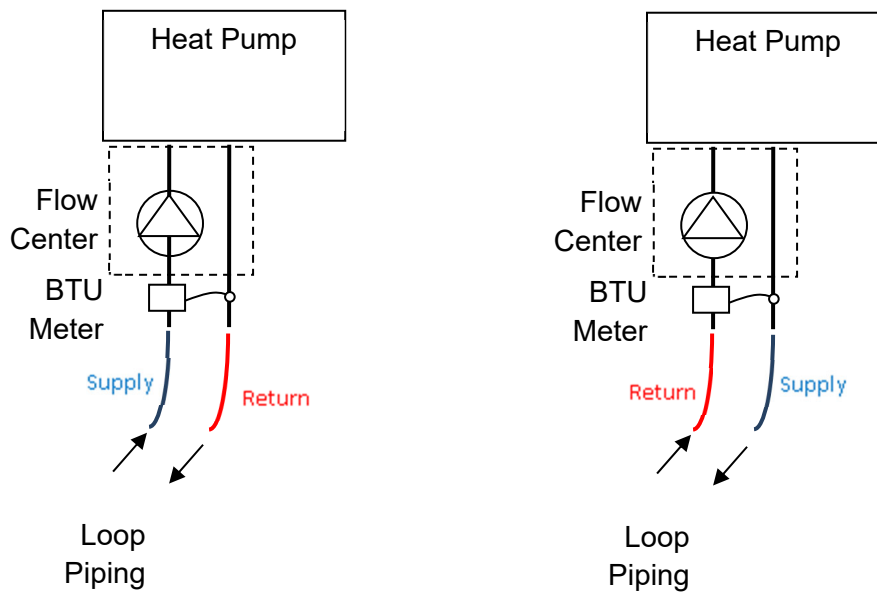


Headering for each Heat Pump Valve to each HP circuit shown (from Turley Inspection Report)



One possible explanation for the unexpected temperatures is that when the supply and return piping comes to the surface near each heat pump the lines were inadvertently switched during installation, as shown by Figure 19. The fact that some heat pumps have intermediate temperatures between the supply and return could be explained by the relative position of that heat pump circuit on the loop header. Depending on the circuit location, the flow from the heat pump on the reversed circuit could directly feed a neighboring heat pump circuit (making that temperature high). Or the entering water from the heat pump could pull water from a mix of neighboring heat pump circuits and the ground loop (making it in between the supply and return).

**Figure 19. Example of How Piping Could be Switched at the Heat Pump**



Another observation corroborating the possibility of one or more reversed HP circuits is shown in Figure 20. The sum of the individual HP flows for each heat pump typically add up to be less than the measured flow on the main loop. Each data point is a 15-minute interval where all the flow data is valid. The data naturally clump into various groupings corresponding to the mix of heat pumps that are operating. The red symbols correspond to periods with all 10 HPs operating at the same time. The summed heat pump flow is 90 gpm (i.e., at the expected design flow), however the flow on the main loop is only 67-75 gpm. Figure 21 shows a similar plot for the heat extraction summed for all the BTU meters on each heat pump compared to the main loop BTU Meter. There is a slight degree of bias due to the uncertainty of summing up 10 individual measurements, though the heat comparison is still in better agreement than the flow comparison.

Figure 20. Comparing Sum of Heat Pump Flows to the Main Loop Flow (red data is when all 10 HPs are ON)

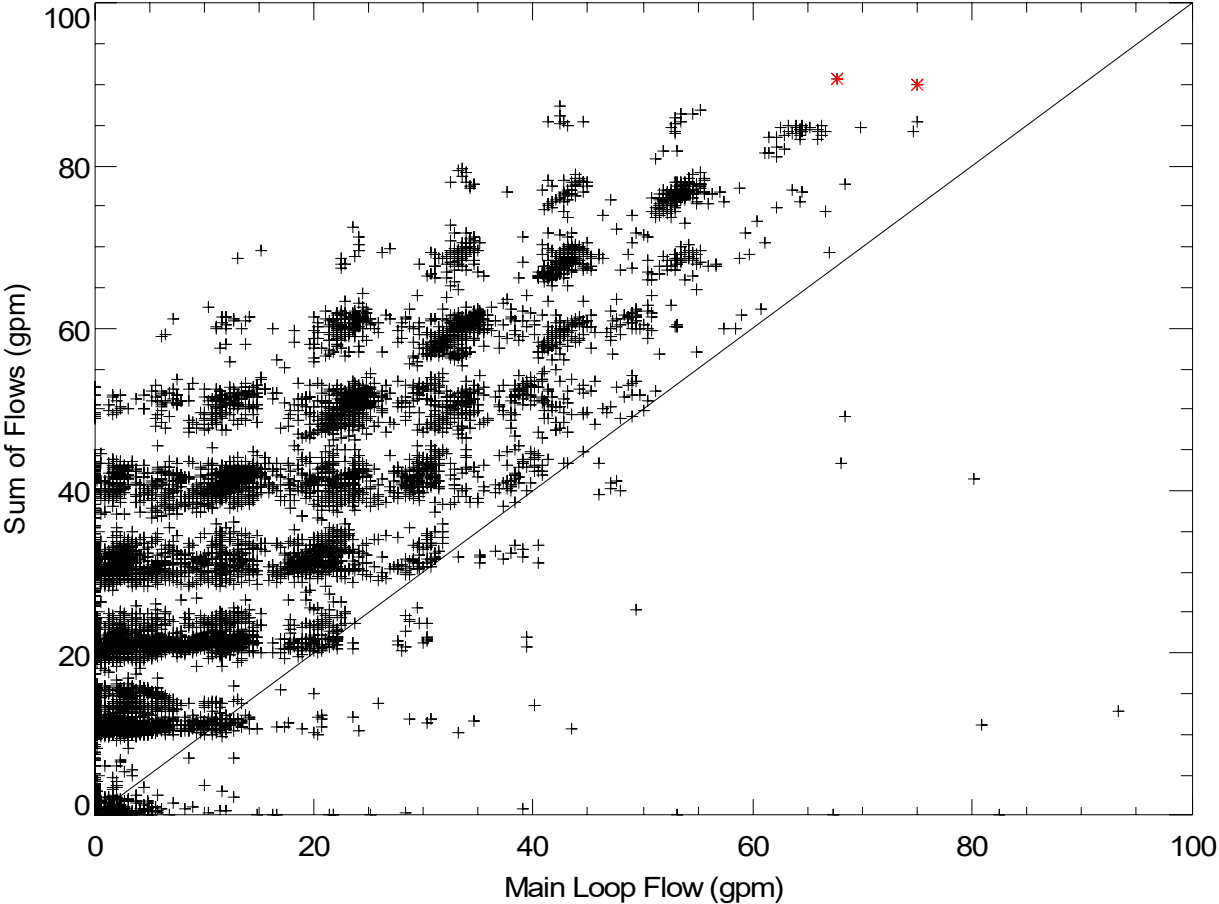
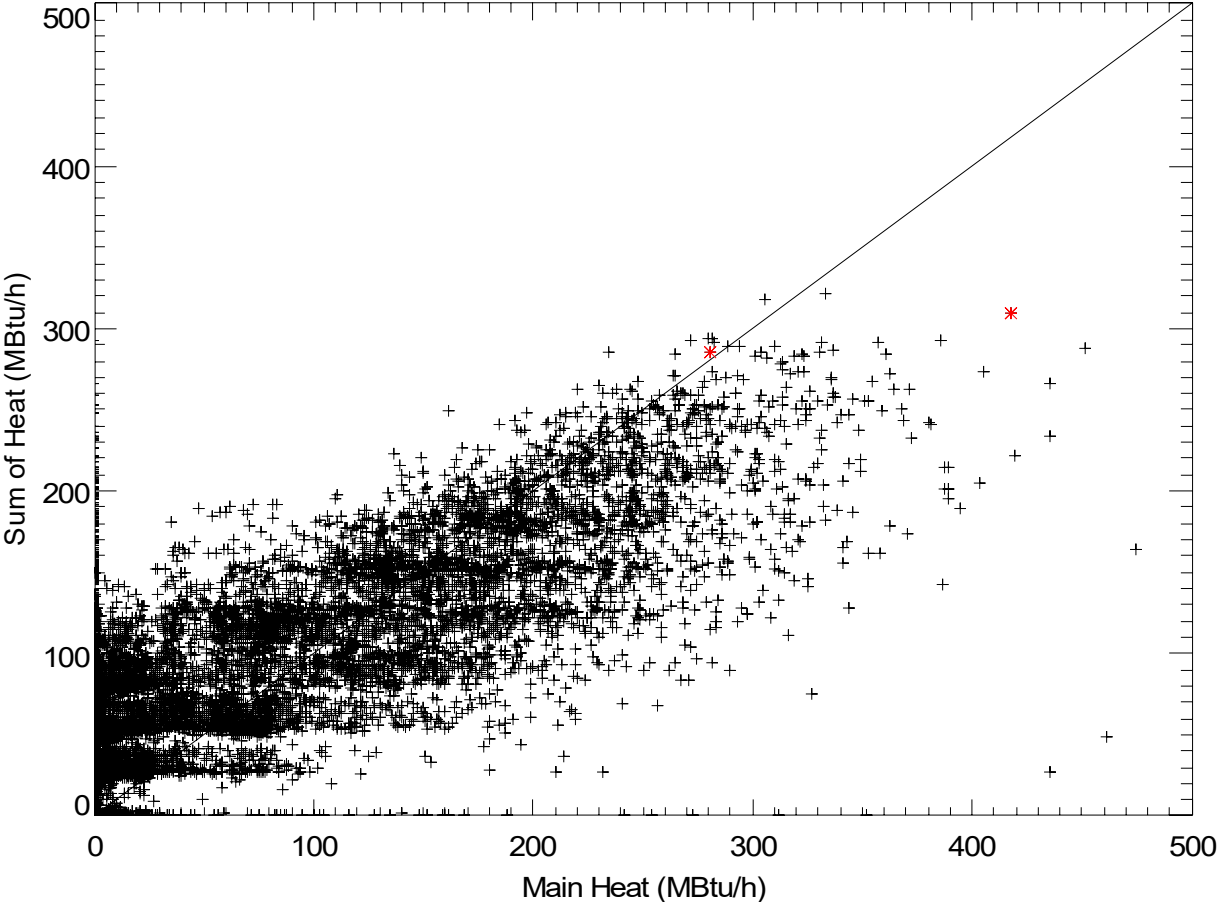


Figure 21. Comparing Sum of BTU Meter Heat Rates to the Main Loop Heat Rates (red data is when all 10 HPs are ON)



#### 4.5.5 Test to Show the Impact of Backwards Flow on HP2

Because the supply temperature for HP2 was very close to the main loop return temperature (as shown in Figure 16), we suspected this unit was the issue. On mid-day September 6, 2018, the contractor visited the site and shut off the flow center for heat pump HP2. Figure 22 shows that when the flow to HP2 was shut off, the sum of all the flows converged with the main loop flow, as expected. The deviation between these flows for other parts of the day was about 20 gpm (or 2 times 9-10 gpm).

**Figure 22 Flow Data for September 6 When Flow was Shutoff**

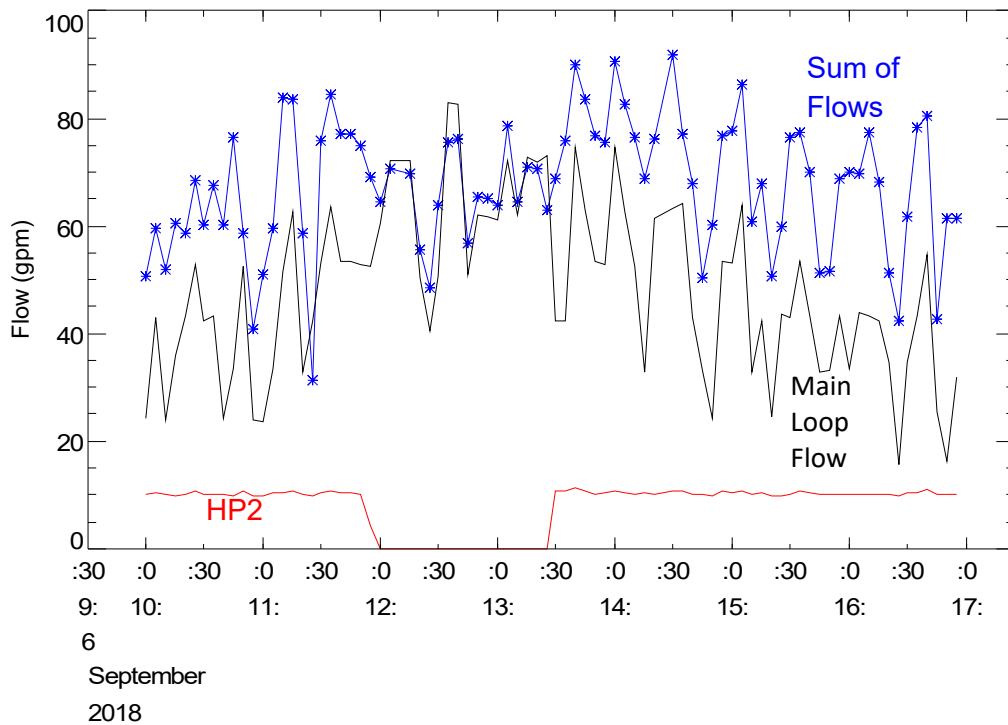


Figure 23 and Figure 24— which are the same plot as Figure 16 and Figure 17 but focused the middle of the day on September 6—show that the entering water temperatures (green data) to several heat pumps (HP6 through HP10) converged to the main loop entering water temperatures when the flow through HP2 stopped. The photos in Figure 18 and Figure 25 show that these HPs are farther from the main supply line than HP2, therefore, they were significantly affected by the warmer water discharged from HP2. This result confirmed that the piping to HP2 had been unintentionally switched.

Figure 23 Loop Temperature Data for September 6 When Flow was Shutoff – HP1 to HP4

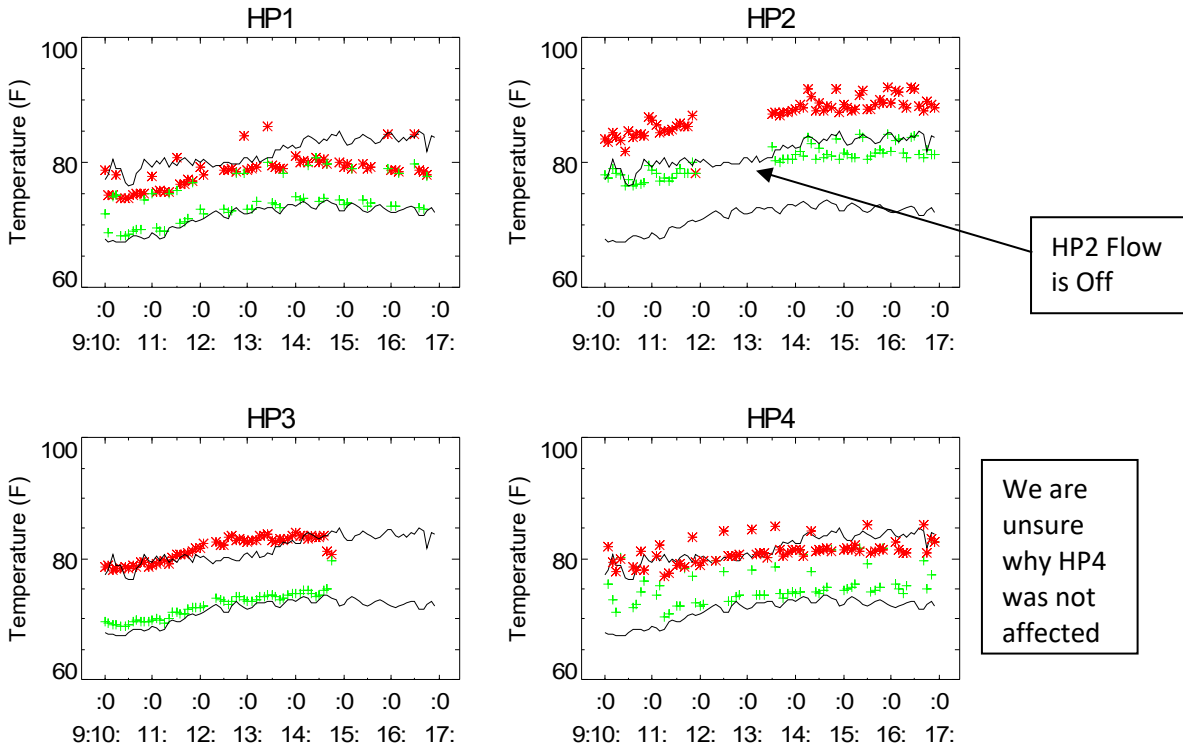


Figure 24 Loop Temperature Data for September 6 When Flow was Shutoff – HP5 to HP10

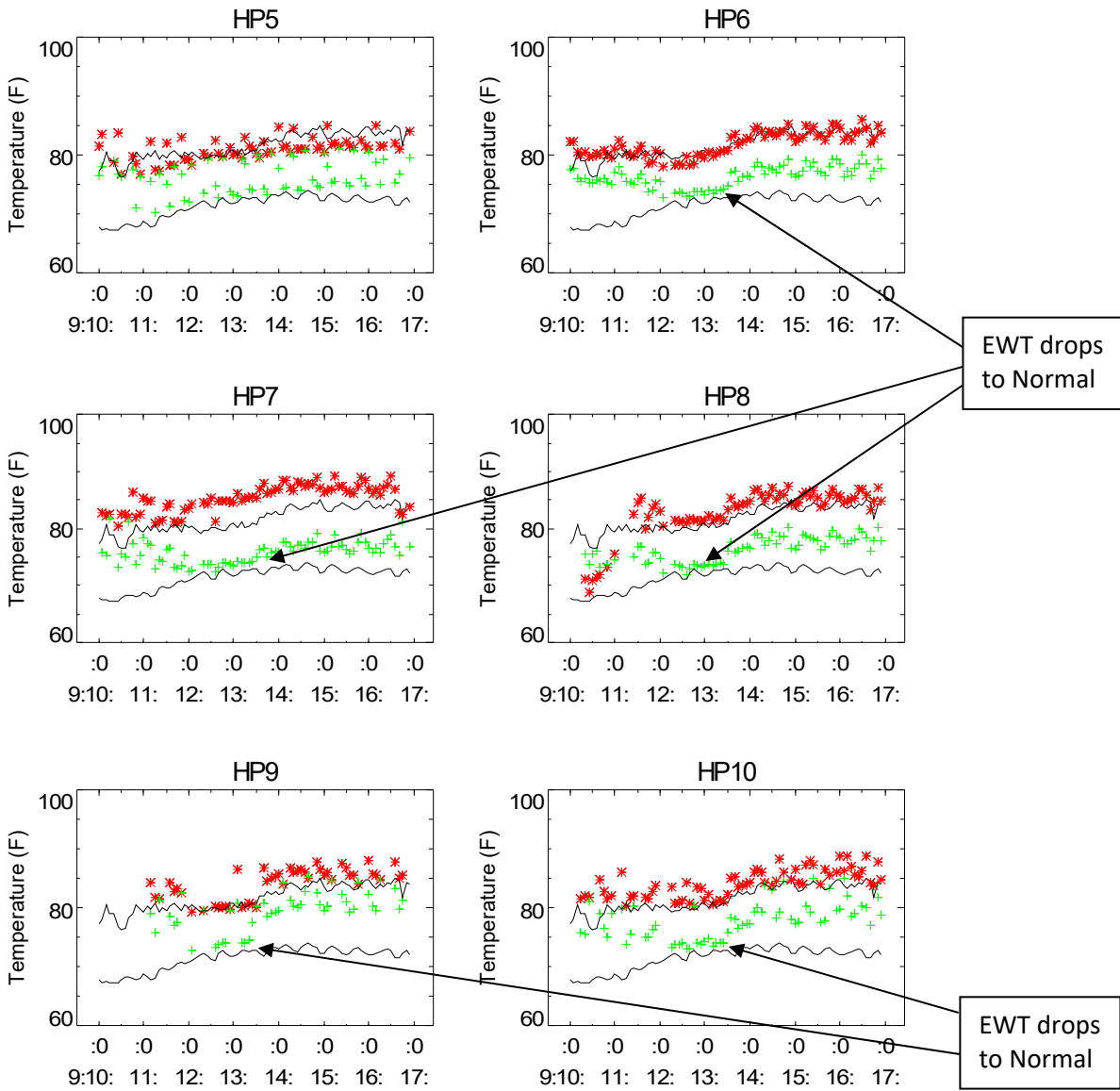
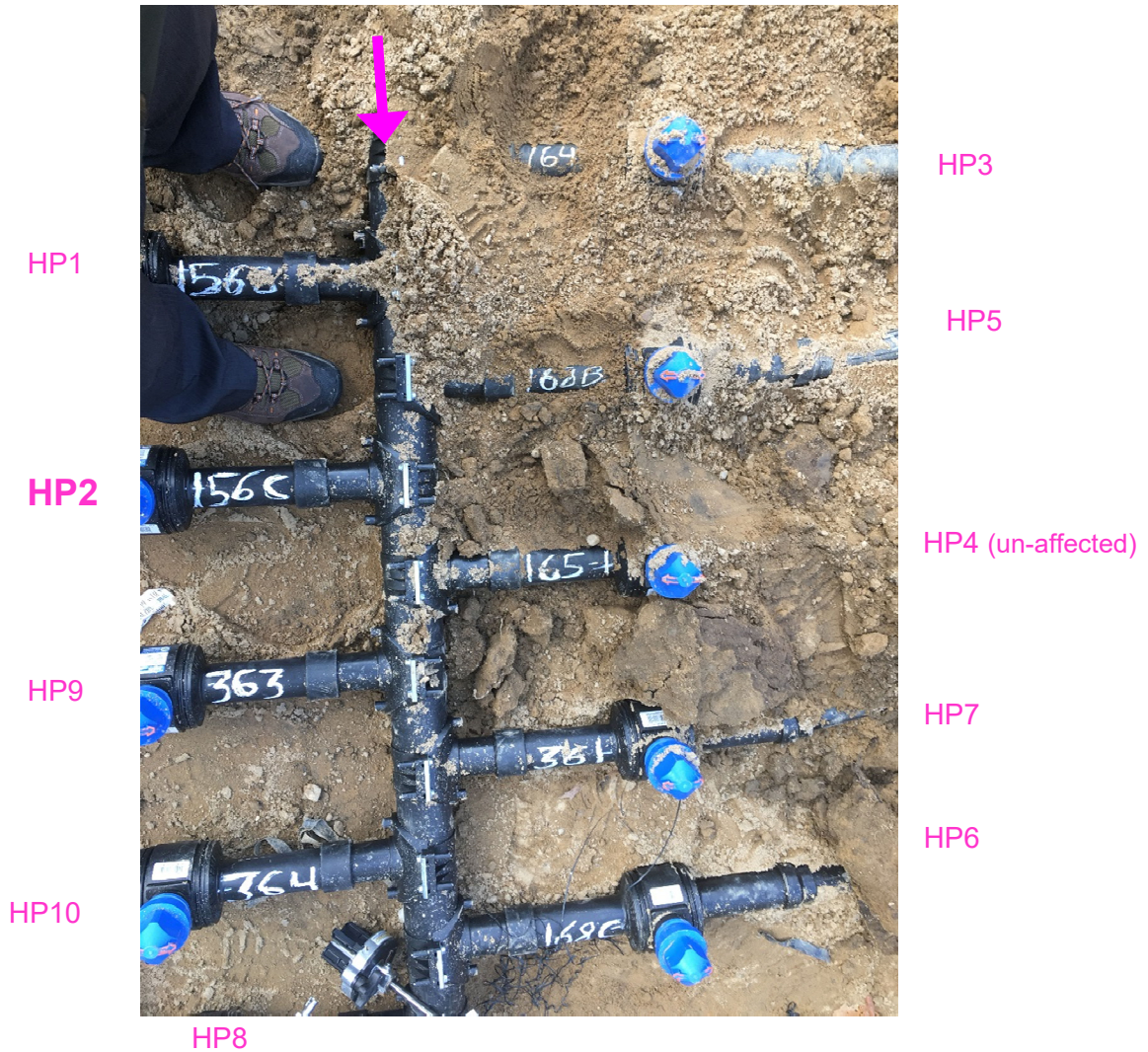




Figure 25 Supply Header Circuiting Details Showing HP 6 through HP10 are Downstream of HP2



On November 6, 2018 the piping was repaired, as shown by Figure 27. The piping fix increased entering temperatures by 4-5°F for more than half of the heat pumps in the heating mode. In cooling mode, the entering temperatures for half of the heat pumps were lowered by 8-10°F. Since each 1°F change in entering temperature changes both heating and cooling efficiency by about 1%, this fix had a significant impact on HP energy use. The efficiencies for about half the heat pumps were lower by about 4-8% before this correction was implemented.

Figure 26 Schematic Showing Impact of Reversed Piping for HP2

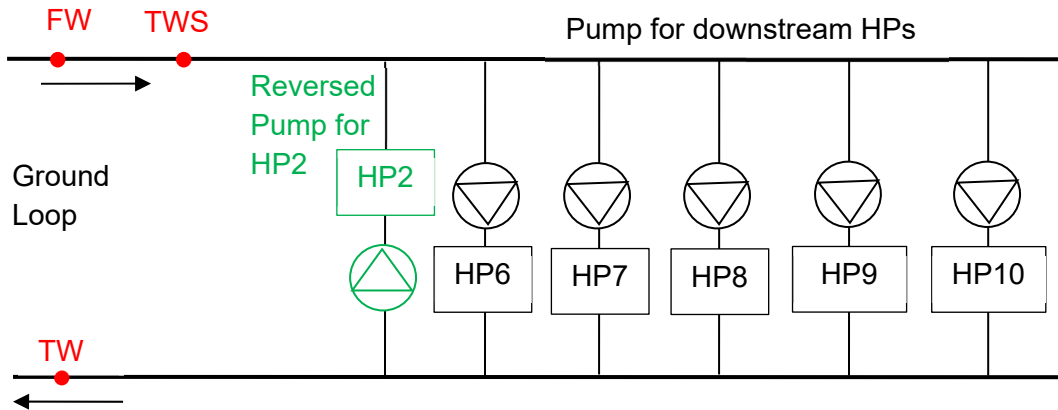
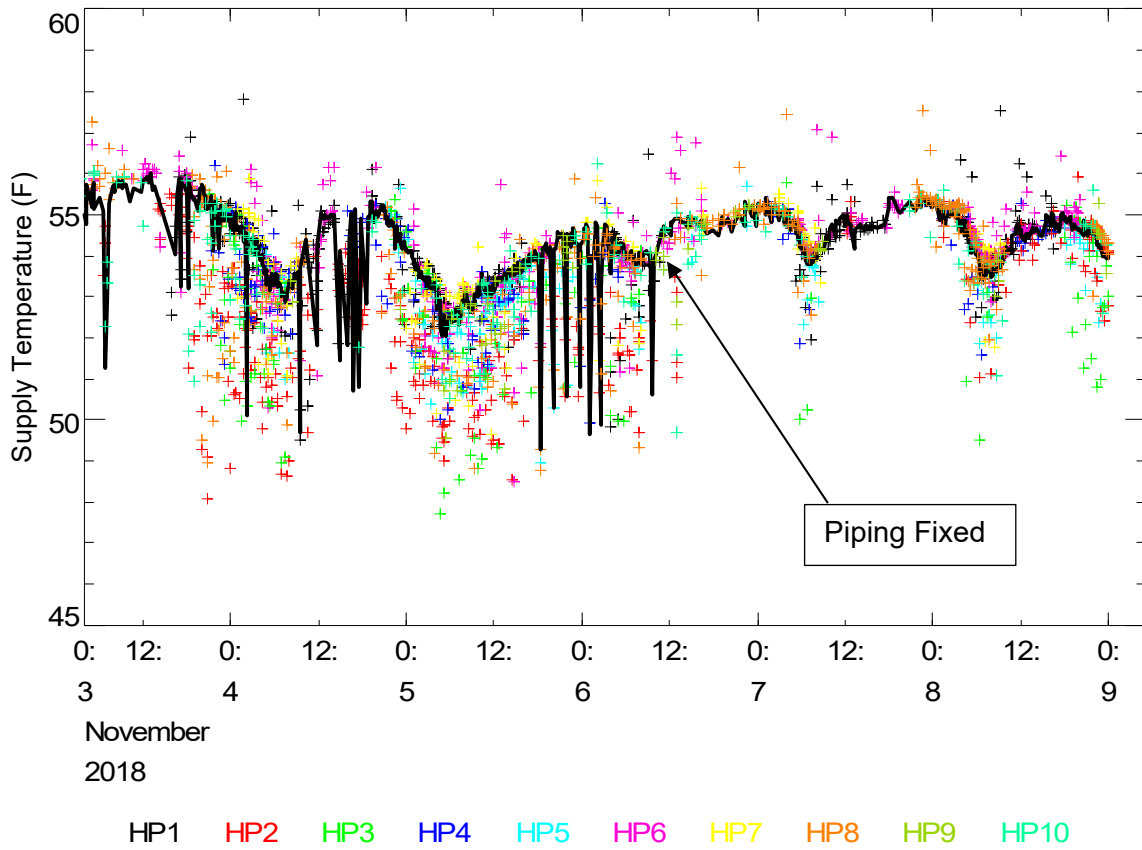


Figure 27 Plot Showing When Piping change was Made for HP2 on November 6, 2018



## 4.6 Estimated Cost Savings

The measured annual data for the GSHP units from Table 8 (for the July 2018 to June 2019 period) were used to evaluate cost savings at each site. Table 25 summarizes the performance data for the GSHP units and Table 26 summarizes the base case assumptions used to determine heating cost savings for both the base and GSHP cases. Table 27 summarizes cooling cost savings. We used average costs for these fuels for the during the 2018-2019 monitoring period (regional cost for propane was \$3.19 per gallon; statewide average kerosene cost was \$3.62 per gallon). The actual fuel costs from the 7 homes that provided fuel delivery logs are provided in Appendix A for reference. We estimated fuel use to meet the measured (post-retrofit) heating loads with the appropriate fuel factors (92 MBtu/gal & 78% efficiency for propane; 134 Mbtu/gal & 81% efficiency for kerosene). Appendix A provides the base case fuel use from these homes and showed that the pre-retrofit fuel delivery data were in reasonable agreement with the fuel use determined from measured heating loads (post-retrofit) –after considering the impact of weatherization improvements. We assumed that electric costs were under LIPA Rate 180 for base case and LIPA Rate 580 for the GSHP system. With these rates, electric cost for cooling was always \$0.21 per kWh. For heating the base cost was \$0.21 per kWh and with GSHPs installed the electric rate was be 2 cents lower.

**Table 25. Summary of Annual Measured Load, Efficiency and Energy Use Data for Each Home**

Unit	Annual Heating Load (MMBtu)	GSHP Seasonal Heating COP	GSHP Heating Use (kWh)	Annual Cooling Load (MMBtu)	GSHP Seasonal Cooling EER	GSHP Cooling Use (kWh)
HP1	33.3	2.20	4,438	10.1	9.5	1,066
HP2	33.2	2.92	3,327	21.6	12.8	1,686
HP3	28.4	3.71	2,240	18.6	14.2	1,309
HP4	26.7	2.48	3,155	15.7	9.8	1,607
HP5	22.9	2.55	2,627	5.1	12.8	397
HP6	39.4	2.40	4,811	9.3	11.9	782
HP7	34.2	3.50	2,867	10.9	15.1	724
HP8	41.5	2.74	4,438	3.0	10.4	286
HP9	23.1	2.81	2,404	9.4	12.4	757
HP10	27.5	2.95	2,726	14.9	13.4	1,112

**Table 26. Summary of Annual Operating Cost Savings from Heating for each Home**

Unit	Base Fuel	Base Annual Fuel Use (Gal)	Base Furnace Fan Use (kWh)	Base Furnace Costs	GSHP Heating Costs	Heating Cost Savings	Heating % Cost Savings
HP1	Propane	464	200	\$1,521	\$843	\$677	45%
HP2	Propane	463	200	\$1,518	\$632	\$886	58%
HP3	Propane	395	200	\$1,302	\$426	\$877	67%
HP4	Propane	373	200	\$1,231	\$600	\$631	51%
HP5	Kerosene	211	200	\$805	\$499	\$306	38%
HP6	Kerosene	363	200	\$1,357	\$914	\$443	33%
HP7	Kerosene	315	200	\$1,184	\$545	\$639	54%
HP8	Kerosene	382	200	\$1,426	\$843	\$583	41%
HP9	Kerosene	213	200	\$812	\$457	\$355	44%
HP10	Kerosene	253	200	\$958	\$518	\$440	46%
Total				\$12,113	\$6,276	\$5,837	48%

Notes: Average fuel costs are \$3.19/gal for propane and \$3.62/gal for kerosene. Appendix A shows actual costs for each home. Propane costs are the average for Long Island for 2018-2019. Kerosene costs are the average statewide for 2018-2019. Heating costs are \$0.21/kWh for base case (LIPA Rate 180) and \$0.19/kWh for GSHP case (LIPA Rate 580).

Base fuel use calculated from measured heating load using propane factors of 92 MBtu/gal & 78% efficiency and Kerosene factors of 134 MBtu/gal & 81% efficiency

**Table 27. Summary of Annual Operating Cost Savings from Cooling for each Home**

Unit	Base AC Cooling Costs	GSHP Cooling Costs	Cooling Cost Savings	Cooling % Cost Savings	Total Savings	Total % Cost Savings
HP1	\$236	\$224	\$12	5%	\$689	39%
HP2	\$505	\$354	\$151	30%	\$1,036	51%
HP3	\$435	\$275	\$160	37%	\$1,037	60%
HP4	\$367	\$338	\$29	8%	\$661	41%
HP5	\$118	\$83	\$35	29%	\$341	37%
HP6	\$216	\$164	\$52	24%	\$495	31%
HP7	\$255	\$152	\$103	40%	\$742	52%
HP8	\$69	\$60	\$9	13%	\$592	40%
HP9	\$219	\$159	\$60	28%	\$415	40%
HP10	\$347	\$233	\$114	33%	\$554	42%
Total	\$2,767	\$2,042	\$725	25%	\$6,562	43%

Notes: Assumed electric costs are \$0.21/kWh for summer months.

Base cooling EER is 9 Btu/Wh

Annual cost savings for heating ranged from \$306 to \$886 (33% to 67%, average of 48%). The sites with propane generally showed higher cost savings. Cooling cost savings ranged from \$9 to \$160 (5 to 40%, average of 25%). Total Savings ranged from \$341 to \$1,037 (31 to 60%, average of 43%).

Table 28 summarizes the greenhouse gas (GHG) reductions for each house considering both heating and cooling. The percent reduction in emissions ranged from 11% to 51%, with an average of 35%.

**Table 28. Summary of Annual Greenhouse Gas Reductions**

<b>Unit</b>	<b>Base GHG Emissions (lb/yr CO<sub>2</sub> equivalent)</b>	<b>GSHP GHG Emissions (lb/yr CO<sub>2</sub> equivalent)</b>	<b>Reduced GHG Emissions (lb/yr CO<sub>2</sub> equivalent)</b>	<b>% GHG Emissions Reductions</b>
HP1	7,324	6,485	838	11%
HP2	8,824	5,907	2,917	33%
HP3	7,591	4,181	3,410	45%
HP4	6,930	5,612	1,318	19%
HP5	5,572	3,564	2,008	36%
HP6	9,504	6,590	2,914	31%
HP7	8,659	4,232	4,427	51%
HP8	9,097	5,566	3,532	39%
HP9	6,178	3,725	2,453	40%
HP10	7,794	4,522	3,272	42%
Total	77,473	50,383	27,091	35%

Assumed emission factors: electricity - 1.18 lb CO<sub>2</sub> equivalent per kWh for Long Island electric grid, propane - 12.44 lb CO<sub>2</sub> equivalent per gal, kerosene - 22.17 lb CO<sub>2</sub> equivalent per gal

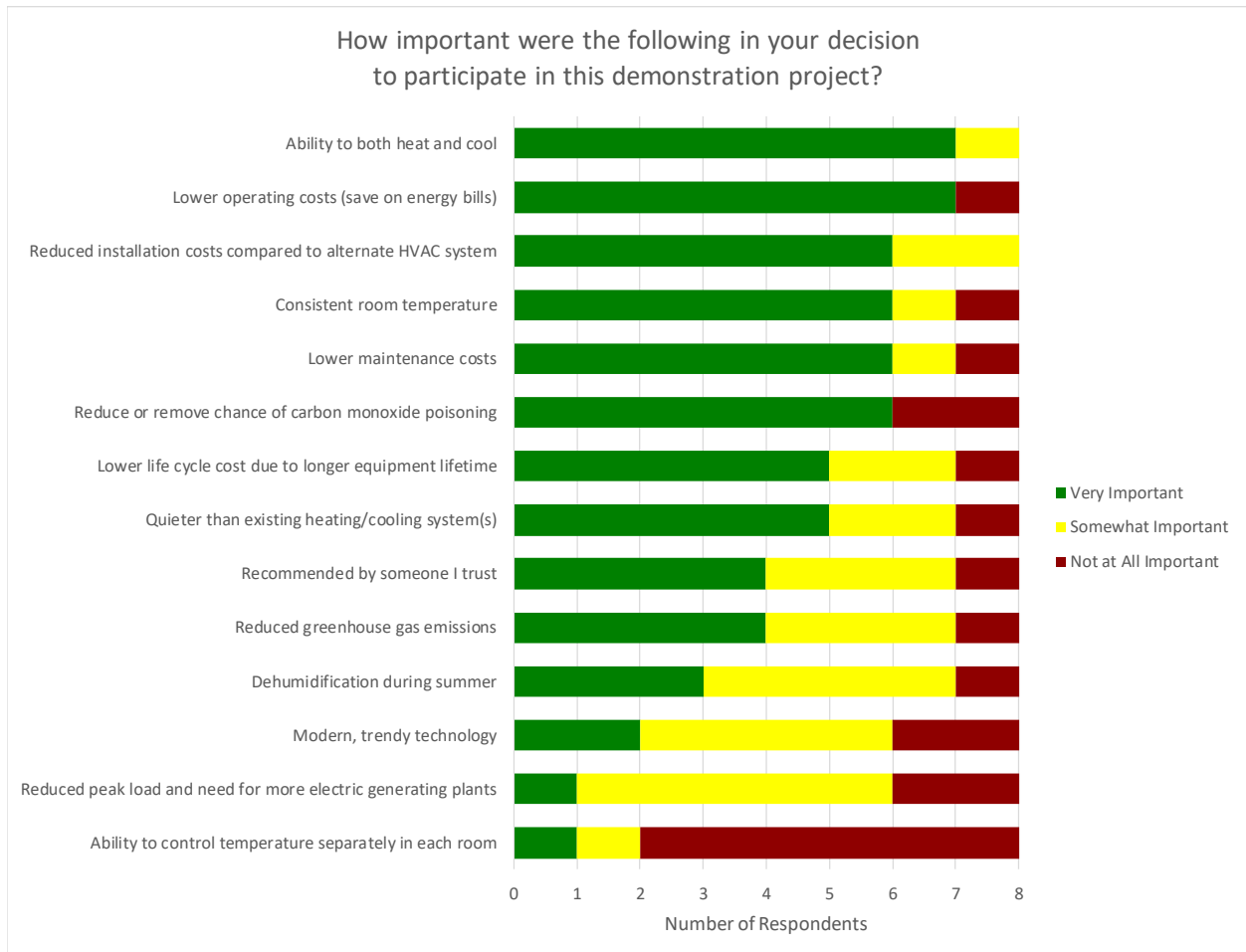
# 5 Homeowner Survey Results

All the homeowners completed an on-line survey around the time the ground source heat pumps were installed and then again after 12 months had passed. At one site the owners changed, and that new homeowner also completed the survey.

## 5.1 Motivations for Participation

The survey results show that homeowners – who were recruited to have their heat pump installed– were primarily motivated by having a better cooling system, reducing heating energy bills and eliminating the hassle and safety issues of delivered fossil fuels.

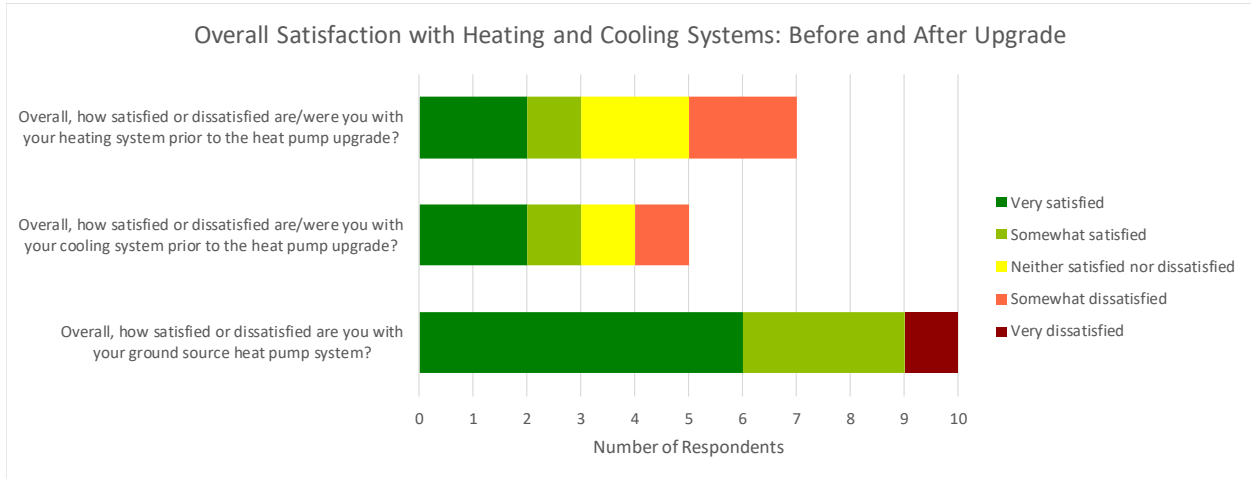
**Figure 28 Survey Results on Homeowner Motivations to Participate in the GSHP Pilot**



## 5.2 Overall Satisfaction

Overall, satisfaction with HVAC systems increased, though one respondent reported decreased satisfaction after the upgrade.

**Figure 29 Survey Results on Overall Homeowner Satisfaction with the GSHP System**

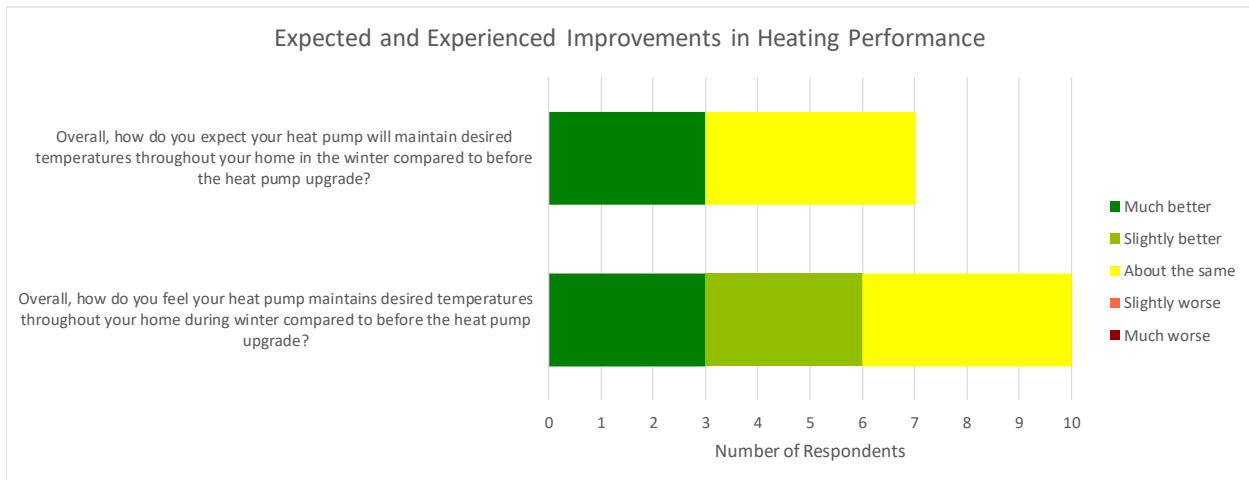
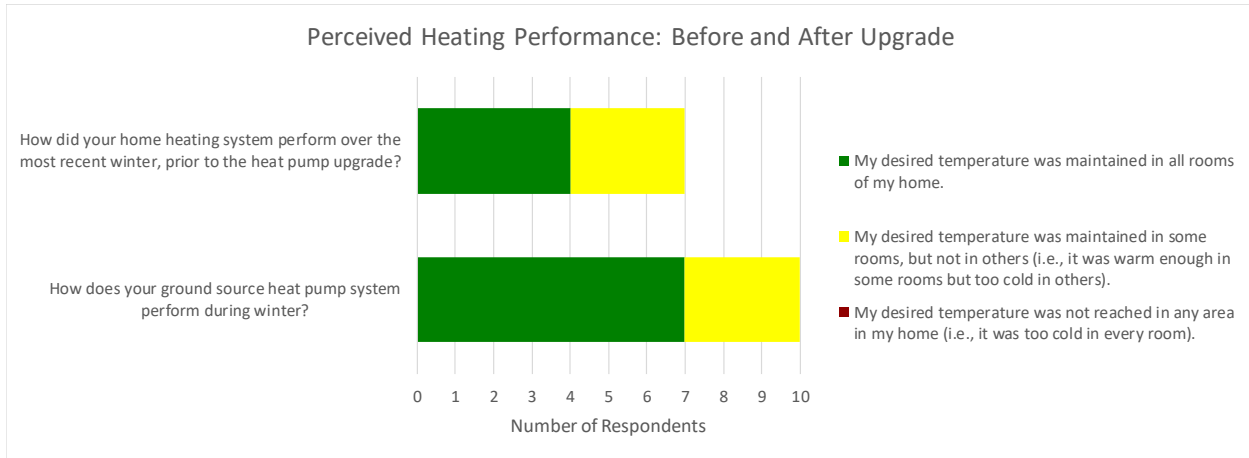




## 5.2.1 Perceived Heating Performance

Generally, respondents were happy with the heating performance of their new system compared to the original system.

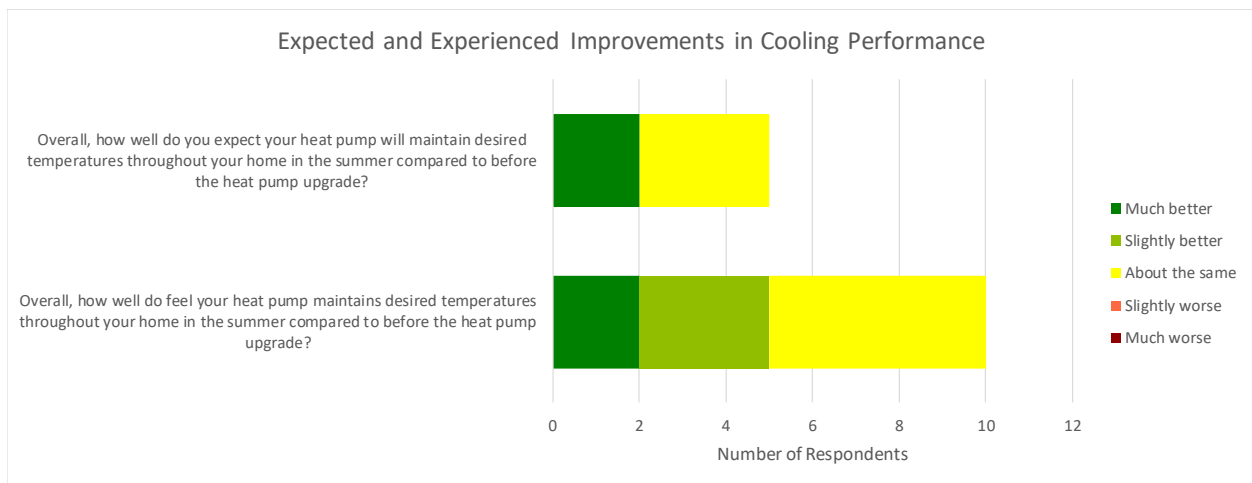
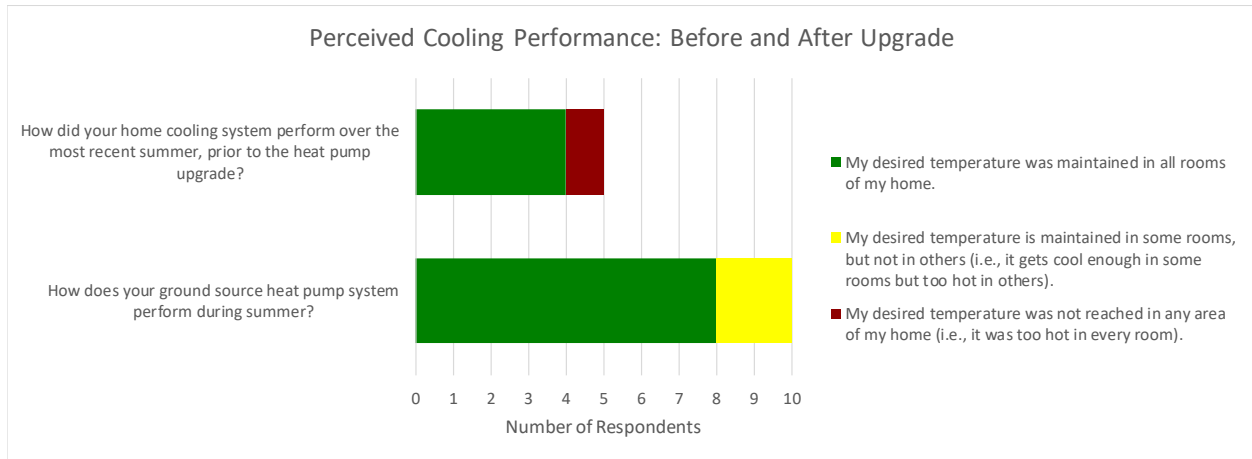
**Figure 30 Survey Results on Perception of Heating Performance Before and After Upgrade**



## 5.2.2 Perceived Cooling Performance

Overall, the new GSHP system is performing better during summer than the previous cooling system. Some homeowners did not have cooling prior or used window air conditioners. All respondents reported cooling maintaining desired temperatures throughout the home during summer to be about the same or better.

**Figure 31 Survey Results on Perception of Cooling Performance Before and After Upgrade**



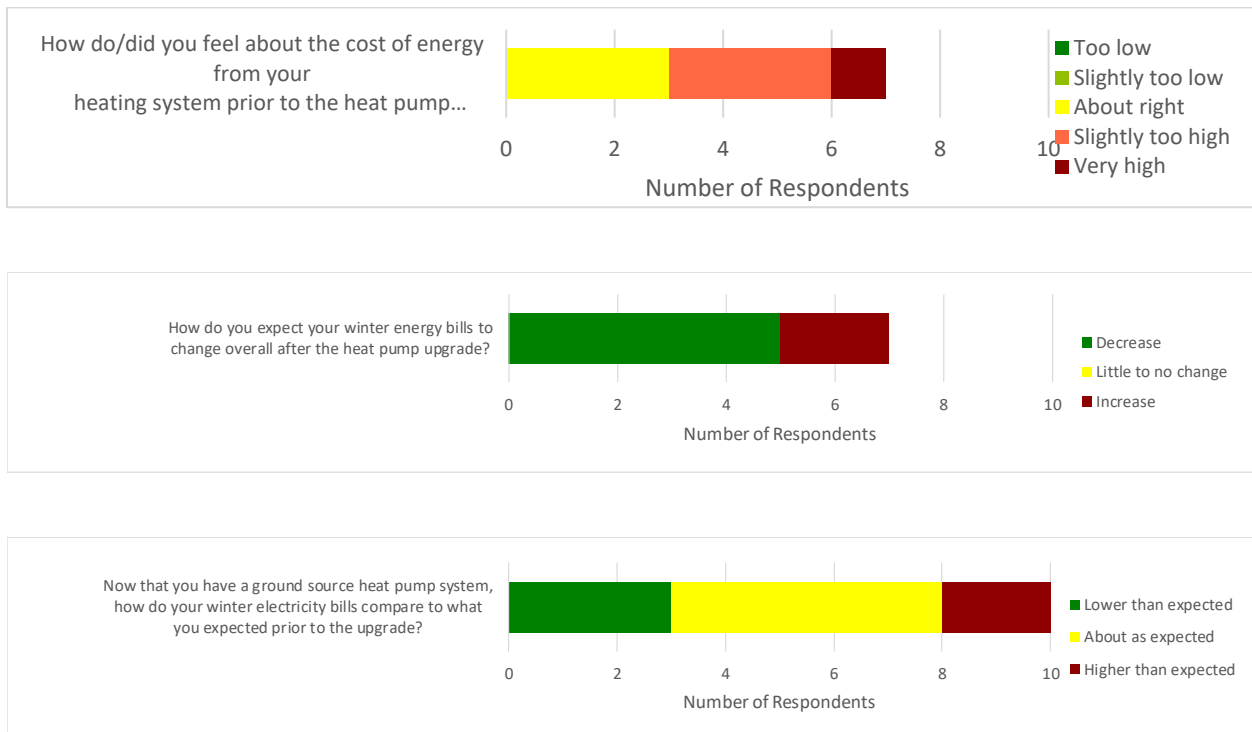
## 5.3 Operating Costs

### 5.3.3 Perceived Heating Costs

Respondents were overall unhappy with their heating costs prior to the upgrade. One-third of respondents expected a decrease in heating costs, and one-third expected an increase in heating costs after the ground-source heat pump upgrade. It was also a mixed bag in experienced results in heating costs, with some thinking their energy bills were lower than expected, some higher than expected, and some about as expected.

Of course, homeowner perceptions on heating costs may be focused on the increase in their electric bills without fully remembering the fuel bill that they no longer had to pay. Actual heating savings were of course the net change in these two bills and ranged from \$306 to \$886 as shown in the previous section (Table 26).

**Figure 32 Survey Results on Perception of Heating Costs Before and After Upgrade**

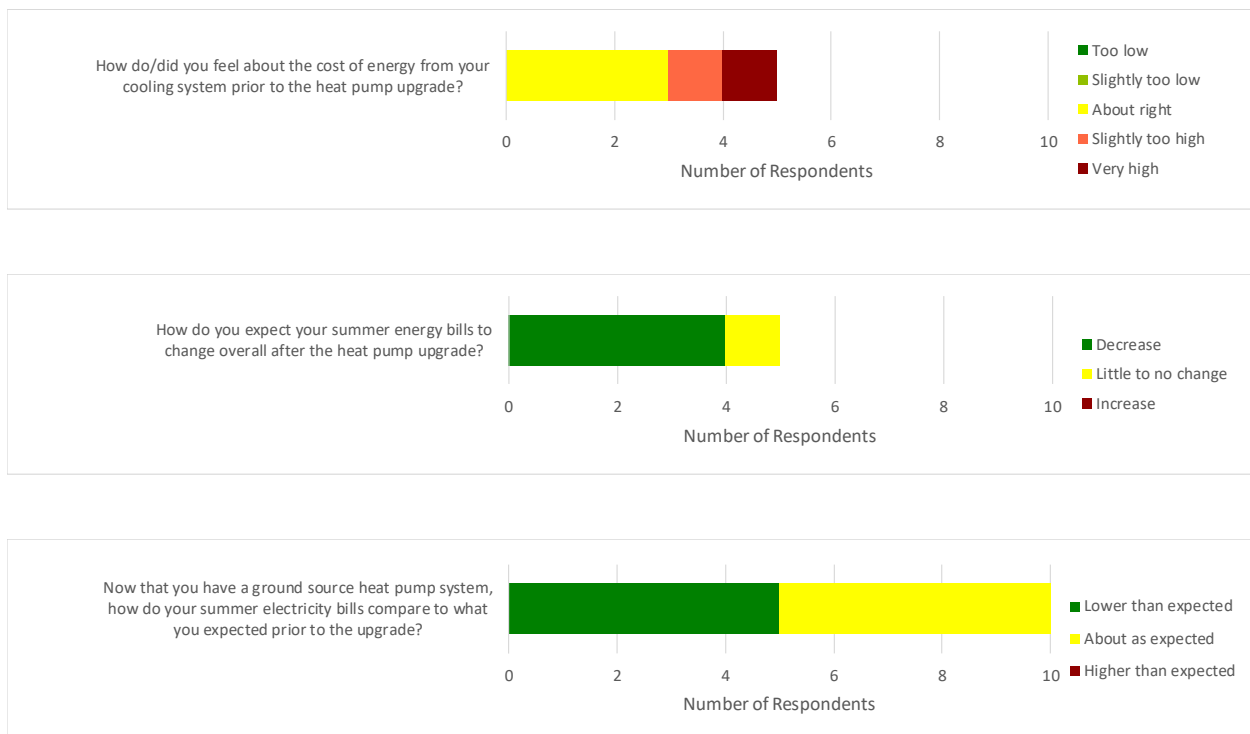


### 5.3.4 Perceived Cooling Costs

Respondents were also unhappy overall with their original cooling costs, but the experiences after the ground-source heat pump was installed was more positive. While most survey respondents expected a decrease in cooling energy costs, about half reported lower electricity bills than expected, and the other half reported bills about as expected. The actual cost savings were all greater than zero (see Table 26), though it is possible that some homes were originally under cooled. Some of the concerns about high utility bills may have been due to thermostat issues experienced by some owners (i.e., some homes had unexpectedly low cooling setpoints which could increase costs).

This shows that some clearer delivery of expectations is needed upfront to customers on increased heating costs, and no change is needed in delivery of expectations in cooling costs.

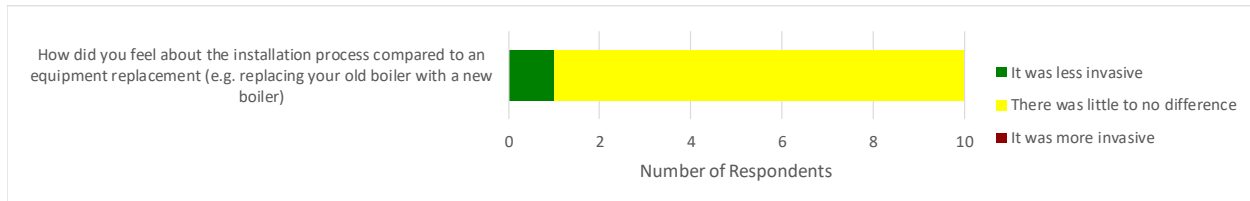
**Figure 33 Survey Results on Perception of Cooling Costs Before and After Upgrade**



## 5.4 The Heat Pump Installation Process

Generally, respondents did not find the heat pump installation a more onerous or invasive process than other types of HVAC equipment such as a furnace. One respondent though the installation was less invasive.

Figure 34 Survey Results on GSHP Installation Process



## 5.5 Highlights from Phone Interviews

Phone surveys were conducted with seven homeowners around the time of heat pump installation, and with five after a year or more. In total we had 12 phone conversations with eight different owners. These calls were held in conjunction with an online survey to give the homeowners a chance to freely describe their expectations and experience. The following key points arose from these surveys:

- **Testimonials matter.** Many of the homeowners knew very little about ground-source heat pumps before being introduced to this pilot program, and they did their research and talked to as many people as they could before signing up. People inside their social and family networks were mentioned specifically. For example, one homeowner stated that they trusted that the park owner wouldn't go forward with the project if it wouldn't be good for them. Other homeowners shared how they had talked through the whole process of installing ground-source heat pumps with someone who had already gone through it.
- **Existing HVAC problems are a decision factor.** One owner stated that their furnace would overheat and then let the temperature drop quickly, resulting in fluctuating temperatures. Many owners complained of outer areas of their home being cooler than the inner areas during winter. All expressed hope that the new system and associated weatherization measures would resolve these issues.
- **Airflow is a concern for some, but not others.** Residents who are used to radiant heating—and those who like the feel of warm furnace air blowing and expected the heat pump system to be the same—complained of the feel of cold air blowing out of the vents. Residents who were used to forced air HVAC and had moderate setbacks of 2-3°F at night seemed happy with the air flow. One homeowner stated that the airflow seemed better than before even though there were no changes to the distribution system.
- **Airflow aside, comfort is improved.** Some specific points mentioned during the surveys include: central air conditioning is much nicer than having window air conditioner units; we are

feeling warm for the first time since being in the house; the heat pump heats the house to a nice temperature; and there is more even heat throughout the house than ever before. One homeowner did mention however that floors were cold despite underfloor insulation.

- **Noise is a concern for some, but not others.** Perception of noise depends on experience and expectations. Like airflow, one resident that was accustomed to radiant heat complained of the noise of the system. In contrast, multiple homeowners expressed their delight at the decreased noise when compared to their previous furnace and central air conditioning—they no longer had to turn up the volume on the TV when the HVAC system came on. One homeowner mentioned having a noisy system when it was first installed, but after a contractor came in and adjusted the fan it was quiet.
- **The air in and around the home is cleaner.** Many of these homes were previously heated by kerosene, stored in a tank next to their house. Multiple homeowners were pleased that they no longer had the smell of kerosene lingering both outside and inside their home.
- **Advanced thermostats come with benefits and drawbacks.** Some benefits that homeowners reported included: it is more controllable than their old thermostat (e.g. scheduling), it is easy to turn the temperature up or down, they love just setting it and leaving it, and they can check on and regulate temperature when on vacation (with a smart thermostat and a phone app). One resident did not appear to understand the thermostat when asked about it. However, another resident stated that not only did the installers help them program the thermostat, they also had a number to dial and get help immediately over the phone, which they had a good experience with.
- **Cost counts—and it's difficult to understand.** Many homeowners were motivated to switch to a ground-source heat pump system from the high and fluctuating costs of kerosene, and an understanding that it was supposed to save them money in the long run for heating. One homeowner mentioned the “sticker shock” from filling a kerosene tank from empty; another would even go and read the tank themselves and call in the delivery at half a tank to avoid the big bill. Post-installation, costs were still a big concern for residents. There seemed to be varying expectations—some expected the cost to be higher than fuel oil, some expected it to be a little cheaper, and others expected it to be much cheaper. Some residents thought “electric is expensive” – not fully understanding the difference between electric resistance heat and electric heat pumps. Some homeowners stated that the first bills coming in were higher than expected. This seemed to be a combination of the result of an extended cold snap, a two-month cycle between meter readings, and changes in utility rates not happening immediately. Many homeowners mentioned some version of “we’ve made some adjustments to temperatures, setbacks, and scheduling, and we are going to wait and see if this helps the next bill”. It may be beneficial to provide homeowners with more immediate feedback on how their actions impact energy use. One resident with cost complaints set the thermostat to 70°F during the day and 60°F during the night throughout winter. Another stated that if they didn’t see lower bills, they’re going to use electric resistance space heaters instead and tear the system out. Multiple owners understood that they should only drop the temperature by 2-3°F degrees at night, but many didn’t understand why.
- **Uninsulated pipes above-ground will freeze.** Several homes experienced freezing pipes as temperatures dropped or were identified as being at risk of having freezing pipes. These homes are above-ground with a crawl space underneath. These pipes were later insulated properly and

covered with spray foam. In our view this was an issue with the homes themselves and was not really related to the GSHP upgrade.

- **Some technical issues with thermostats.** One resident stated that their thermostat incorrectly called for emergency heat when in heating mode. This issue was corrected by replacement of a malfunctioning part by the contractor. Another homeowner stated that their thermostat had a default setpoint of 50°F which they were unable to override. This issue was corrected, but it took nine days to fix. Another homeowner is upset with the location of their thermostat by the water heater, as they believe that location is not a good representation of the temperature of the living space.
- **More customer training is needed.** One homeowner claimed they were told they should leave the house at 65°F when they were not home. After a month away, they were upset with how high the electric bill was for an unoccupied house. More detailed instructions should have been provided on when it makes sense to turn down the heat to provide optimum savings. Another homeowner understood that it was necessary to clean the filter regularly, but found difficulty pulling it out, and then after washing it, ended up buying another filter to use while it dried, assuming it couldn't be put back in while wet.
- **Contractor work and interactions were satisfactory.** All homeowners were satisfied with the work and the manner of interactions with the various contractors. One stated that they were happy with the level of communication—they were told in advance when someone was going to be there. Another mentioned that at the time of installation, they felt like they had a lot of people coming in and out of their home. This was more than they expected when comparing to a simple changeout of their old system but looking back now it doesn't seem so bad.
- **The rest.** A homeowner was confused why a heat pump unit with a three-year warranty stamped on the unit had only a year of warranty left after the installation date. Another homeowner had done their research, and they were happy that it was a two-stage system going in, so it didn't need to work on full if it wasn't needed.



## 6 Summary and Conclusions

---

National Grid and NYSERDA undertook this demonstration project to understand the potential benefits of a ground source heat pump system that serves multiple homes using a community or common ground loop. The community loop, ground source heat pump system was installed in an existing housing development in Riverhead, NY. The single-family, detached homes ranged from 900 to 1600 square feet and included new homes as well as existing homes built as early as the 1970s. A community loop with 20 vertical bores was installed in a common area close to the ten homes. The system included about 150 ft of vertical bore per installed ton. Dual-stage, 3-ton heat pumps were installed each home. Due to space limitations in the furnace closets in the homes, eight heat pumps were split units with separate indoor and outdoor sections. These split systems had approximately 10% lower rated efficiencies.

A data acquisition system with BTU Meters and power meters was installed on each heat pump to quantify the capacity and efficiency of each unit in the heating and cooling modes. Total loop performance was also measured. The power use and runtime of key components were also measured to understand performance differences.

### 6.1 Overall Heat Pump Performance

Overall the average seasonal heating COP was 2.83 for the all the HP units, or about 70% lower than the COPs implied by the full and part load AHRI-rated COPs (the average of full and part load rated COPs was 4.0). The seasonal average COP for the different units ranged from 2.20 to 3.71. Some of the reasons for the measured differences in heating efficiency were:

- The two packaged units had measured COPs of 3.7 and 3.5, and average of 3.6. The measured COPs for split systems ranged from 2.2 to 2.95, and average of 2.63.
- The fan power associated with the units ranged from 232 to 466 Watts, most-likely due to differences in the ductwork and different air flows in each house. The implied airflows ranged from 978 to 1198 cfm, or 326 to 400 cfm per ton. A trend of higher COP with lower fan power was observed.
- Pump power ranged from 165 to 407 Watts as the loop flow through each heat pump varied from 6 to 11 gpm. The trend of higher COP with lower flow and power was observed.
- Three of the heat pump units (all split systems) did NOT vary fan power (and airflow) as the compressor changed between high- and low-stage operation. This resulted in excess fan power and a lower net system COP for low-stage operation.

We also noted the that system design with a dual-stage heat pump combined with constant speed pumping resulted in a lower COP for low-stage operation. Since units were generally oversized (see Appendix B), the units all spent the vast majority of their operating time at low stage. The measured data showed that

the low-stage COP was generally 5-15% lower than in high-stage operation. The theoretical analysis with manufacturer's data at the end of Appendix C corroborated this impact.

## **6.2 Ground Loop Performance**

The supply temperatures from ground loop heat exchanger stayed well within the stated design conditions of 37°F minimum in heating and 80°F maximum for cooling. The resulting loop sizing was 150 ft of vertical bore per installed ton. Since the heat pumps were generally oversized, the load on the system resulted in supply temperatures that rarely dropped below 45°F in the winter or rarely exceeded 70°F in the summer.

We observed that the coincident peak load imposed on the ground heat exchanger was less than the sum individual (non-coincident) loads of each heat pump. This peak load coincidence was 85% in the summer and 82% in the winter – more diversity than might be expected given the very similar load characteristics of these single-family homes.

One problem we found was that the piping from the ground loop to HP2 was hooked up backwards. This caused the entering temperatures for HP2 to be at the return conditions: i.e., warmer in the summer and colder in the winter. Even worse, this pumping mistake negatively impacted the entering water temperatures for at least four additional heat pumps.

This mistake of switching pipes occurred because the system used a common loop with individual flow stations on each heat pump. In a conventional geothermal system with a single heat pump, the problem of keeping track of the supply and return piping in the trenches is unnecessary. For a larger system with a common ground loop and centralized pumping, reversed flow issues are easier to detect and fix during normal course of test and balancing. The common loop with individual pumping creates a new issue – not normally considered by loop installers – that must be carefully tracked during loop construction. In this case, a very thorough commissioning process implemented by a highly qualified loop inspector was not able to detect the problem. It was only found after the fact using detailed monitored data in the summer months.

## **6.3 Cost Savings**

The cost savings for each home were determined using an assumed electric cost and regional or statewide fuel costs. Heating savings ranged from \$306 to \$886 per year (33% to 67%, average of 48%). The site with propane had the largest savings. Cooling savings ranged from \$9 to \$160 (5% to 40%, average of 25%). Total savings range from \$341 to \$1037 (31% to 60%, average of 43%). Annual savings for all 10 sites was \$6,562. The system cost of \$301,570 results in a simple payback of 46 years.

The average greenhouse gas savings were 35%.

## 6.4 Survey Results

We conducted on-line surveys of the homeowners when the heat pumps were first installed and then after a year of operation. At most sites, we followed with phone interviews.

The survey results show that homeowners who participated in this project were primarily motivated by: 1) having a better cooling system, 2) reducing heating energy bills and 3) eliminating the hassle and safety/health issues of delivered fossil fuels.

Homeowners were generally satisfied with the performance of the new cooling system and operating costs of their cooling system, though some did perceive higher than expected costs. For heating, their perception of operating costs below expectations for slightly more than half of the respondents – even though we demonstrated that all of the homes had heating cost savings based on measured data. One issue driving expectations could be the fact that homeowners might tend to “forget” the fuel bill they no longer pay but clearly “remember” the larger electric bill that continues to come each month. This may skew their perception of any net savings between the two bills.

Some homeowners reported problems using and understanding with the new electronic thermostats. To corroborate this, we observed that several homes seemed to have cooling set points that were unexpectedly low (70°F, 66°F, etc.). We also observed some heat set points in the low 60s. Problems with maintaining desired temperatures and controlling set back seemed to have been an issue for some homeowners.

## 6.5 Conclusions and Lessons

As a result of this study, we make the following observations and lessons for future applications of community ground source heat pump systems as well as for residential GSHP systems in general.

GSHP Retrofits are Difficult in Some Existing Homes. The single-family homes in this project were all originally heated by fuel-fired furnaces. The furnace closets in these manufactured homes were space constrained so that less-efficient, split-system GSHP units had to be installed in eight of the homes. In addition, the existing furnace ductwork in some homes was undersized relative to the higher airflows required by the heat pump units. Some leaks in this ductwork also had to be repaired before the heat

pumps were installed. The result was higher installation costs, lower heat pump efficiency, and greater fan power than might be expected in more ideal applications.

### **Common Loops Have Benefits and Drawbacks.**

- **Leveraging Load Diversity.** Installing multiple heat pumps on a common ground loop has potential benefits of improved load diversity. At this site we measured 80% coincidence of peak loads (where 100% equates to perfect coincidence or no diversity). Load diversity (or lack of coincidence) can result in better overall performance than dedicated loops installed to serve each heat pump with the same number of vertical bores. Load diversity is highest with mixed applications, such as combining retail and residential, and lowest when the loads are the same, such as a group of single-family homes.
- **Loop Pumping.** Common loops with centralized variable speed loop pumping offer significant pumping savings at part load – which is one of the largest benefits of a common ground loop. Common loops with individual pumping offer smaller pumping savings, since the Watts per actual gpm remain constant as part load. In general, we estimate centralized variable speed pumping might reduce annual pumping energy by a factor of two compared to individual pumping.
- **Construction Costs.** The cost of constructing a common loop with individual pumping (as used in this study) was greater than the cost of installing multiple individual ground loops for each heat pump as one construction project. If designers can take advantage of the load diversity in common loops by installing a smaller ground heat exchanger to reduce cost and also reap the operating benefits of centralized variable speed pumping, then the cost and performance benefits of common loops may be greater than the drawbacks.

**Modulating Heat Pumps Require Modulating Flows.** Heat pumps that are dual-stage or variable-speed should also be able to vary loop flow and airflow to achieve the best performance. The dual stage heat pumps in this study were designed with constant speed pumping. As a result, the low-stage COP was about 10-15% lower than the high-stage COP – negating the expected seasonal efficiency benefit of the dual stage unit. In addition, the airflow on three heat pumps did not vary with heat pump capacity as expected (presumably due to an improper unit setting). Care must be taken during installation, setup and commissioning to ensure modulating flow is achieved. For GSHP units in this project, using a single stage thermostat with only the unit’s high-stage would have improved seasonal system efficiency.

**Higher System Efficiency at Modest Flows.** While the efficiency of a heat pump unit can be higher at higher airflows and loop flows, the efficiency of the combined system, including pumps and fans, usually decreases at higher flows. Meeting or exceeding common rule-of-thumb targets for loop flows and airflows usually result in lower overall system COPs. In terms of airflow, HVAC systems often have

optimal efficiency at flow rates from 350-375 cfm per installed ton. Similarly, loop flowrates should be selected to ensure reliable operation at all operating conditions. The most efficient loop flow rate is usually lower than 3 gpm per installed ton.

# Appendix A: Analysis of Fuel Bills from Existing Homes

---

Fuel delivery logs were available for 7 of 8 existing homes. The logs included the amount of fuel delivered for each period and the fuel cost. Table A-1 summarizes the collected fuel use data determined by summing up the fuel deliveries for the year (i.e., the “Simple Sum”). We also use the loads lines developed from regression analysis to predict annual fuel use using the TMY-2 bin temperature data for JFK airport (see Figures A-1 to A-7). The simple summation sometimes crossed the 12-month boundary, so the annual total fuel use determined from the temperature bin analysis was thought to be more accurate.

**Table A-1. Summary of Annual Fuel Use and Costs**

HP Unit No	House	Original Heating System	Average Fuel Cost (\$/gal)	Annual Fuel Use - Simple Sum (gal/yr)	Annual Fuel Use - Bin Analysis (gal/yr)
HP1	156B	Propane Furnace			
HP2	156C	Propane Furnace	2.6	575	500
HP3	164				
HP4	165				
HP5	168B	Kerosene Furnace	3.39	230	227
HP6	168C	Kerosene Furnace	2.96	318	381
HP7	361	Kerosene Furnace	2.75	296	393
HP8	362	Kerosene Furnace	3	757	489
HP9	363	Kerosene Furnace	2.73	229	237
HP10	364	Kerosene Furnace	3.71	362	444

Table A-2 compares the annual heating load determined from measured data to the annual load implied by the fuel use data. Generally, the heating loads implied by the annual fuel use (before weatherization) are 8 to 75% higher than the measured (post-retrofit) heating loads with the new heat pumps. This makes sense given that weatherization activities should have decreased the heating load served by the GSHP system. However, HP2 and HP9 were not weatherized yet still show 8 and 11% differences, respectively – providing some indication of the uncertainty of this bill-based comparison

**Table A-2. Comparing Measured Heating Loads to Annual Fuel Use**

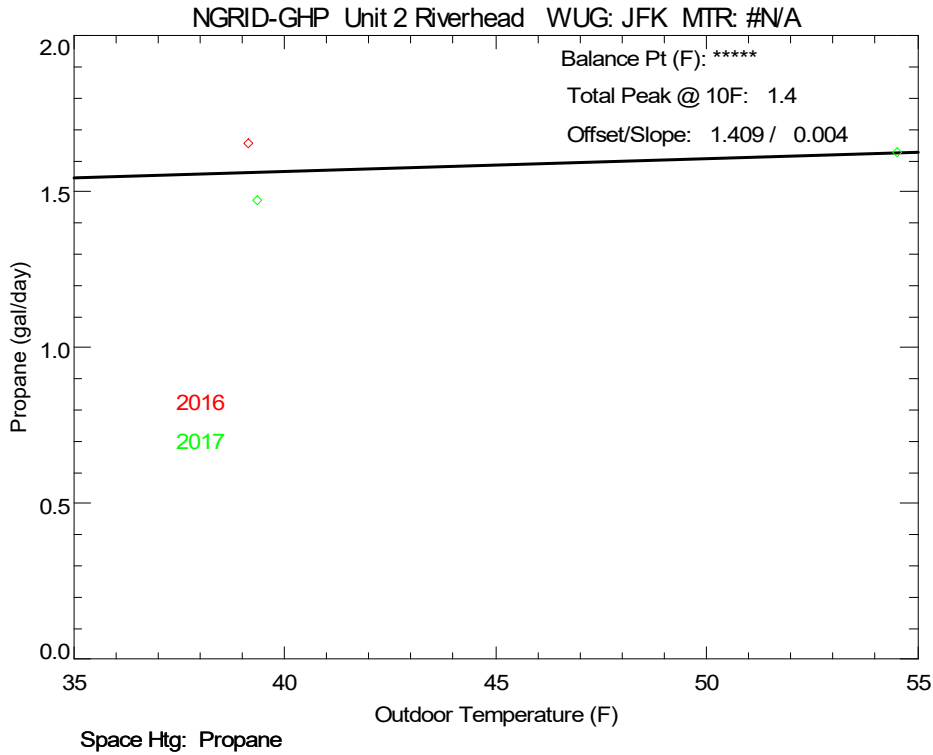
HP Unit No	Air Tightness	Insulation Added	Annual Fuel Use (gal/yr)	Heating Load - Implied by Fuel Use (MMBtu)	Heating Load – Measured Data (MMBtu)	Fuel- Measured Percentage Difference
HP1	None				33.3	
HP2	None		500	35.9	33.2	+8%
HP3	None				28.4	
HP4	None				26.7	
HP5	Tighter by 47%	Underfloor	227	24.6	22.9	+8%
HP6	Tighter by 23%	Underfloor	381	41.4	39.4	+5%
HP7	Tighter by 33%	Underfloor	393	42.7	34.2	+25%
HP8	Tighter by 15%	Underfloor	489	53.1	41.5	+28%
HP9	None		237	25.7	23.1	+11%
HP10	Tighter by 40%	Previously	444	48.2	27.5	+75%

Notes: Assumed factors for Propane: 92 MBtu/gal & 78% efficiency. Kerosene: 134 MBtu/gal and 81% efficiency

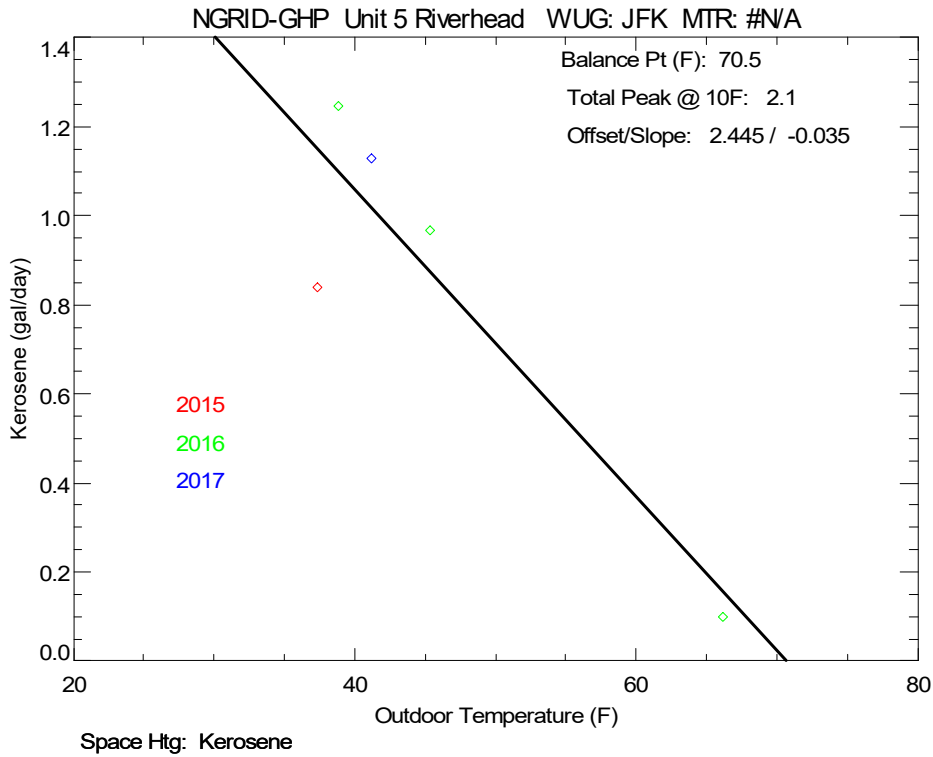
The largest variation between pre- and post-weatherization loads was for HP10 at 75%. At this site the air tightness was improved by 40%, but no other work was done. However, the homeowner reported that their home had been previously weatherized before this project as part of another LIPA program. Since the measured fuel use data for HP10 was from the 2015-2016 period (see Figure A-7), it appears that this unknown weatherization happened after that period and therefore the savings (in Table A-2) also include the impact of this activity. The implied savings from weatherization at HP5 to HP8 ranged from 8 to 28%. The average implied reduction in heating load due to weatherization was 17% for the four homes.



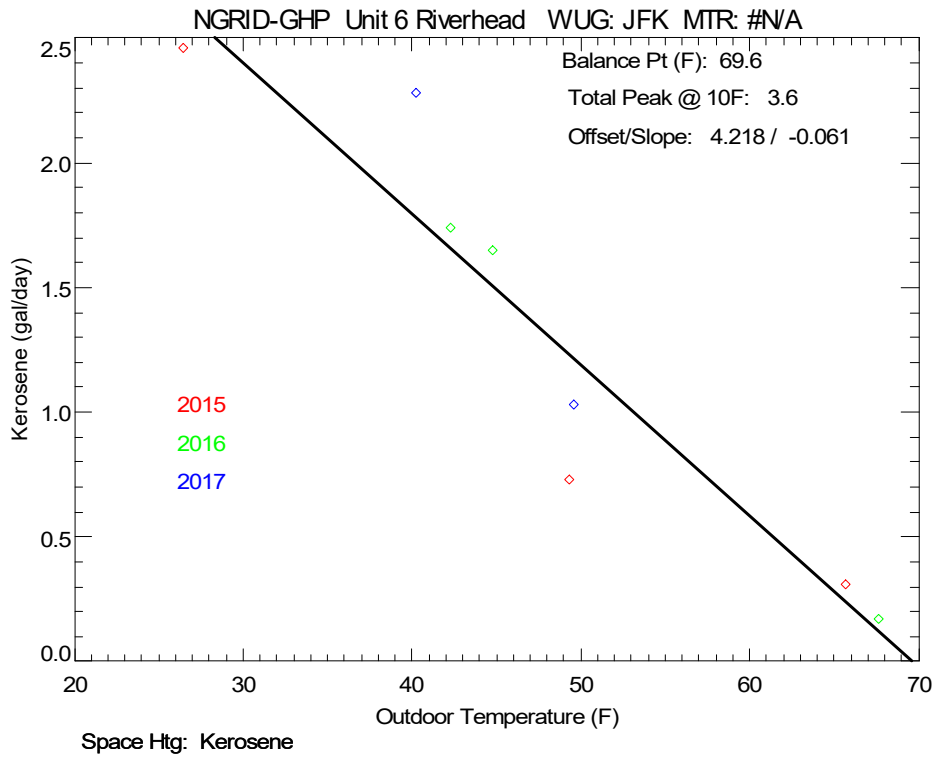
**Figure A-1. Fuel Delivery Logs vs. Outdoor Temperature for Site 1**



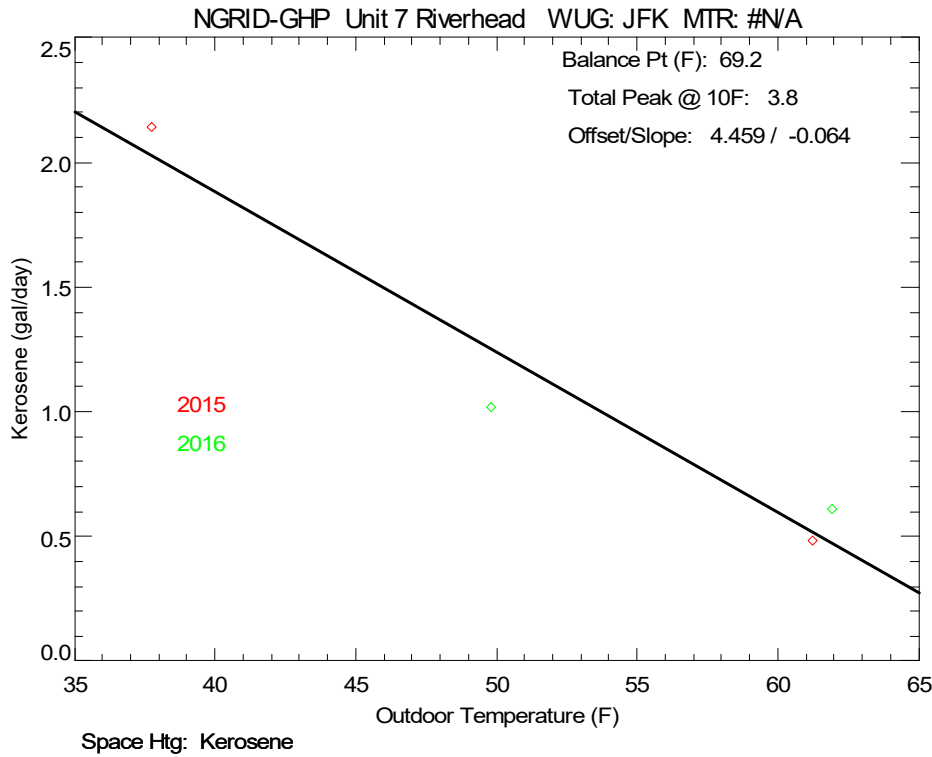
**Figure A-2. Fuel Delivery Logs vs. Outdoor Temperature for Site 5**



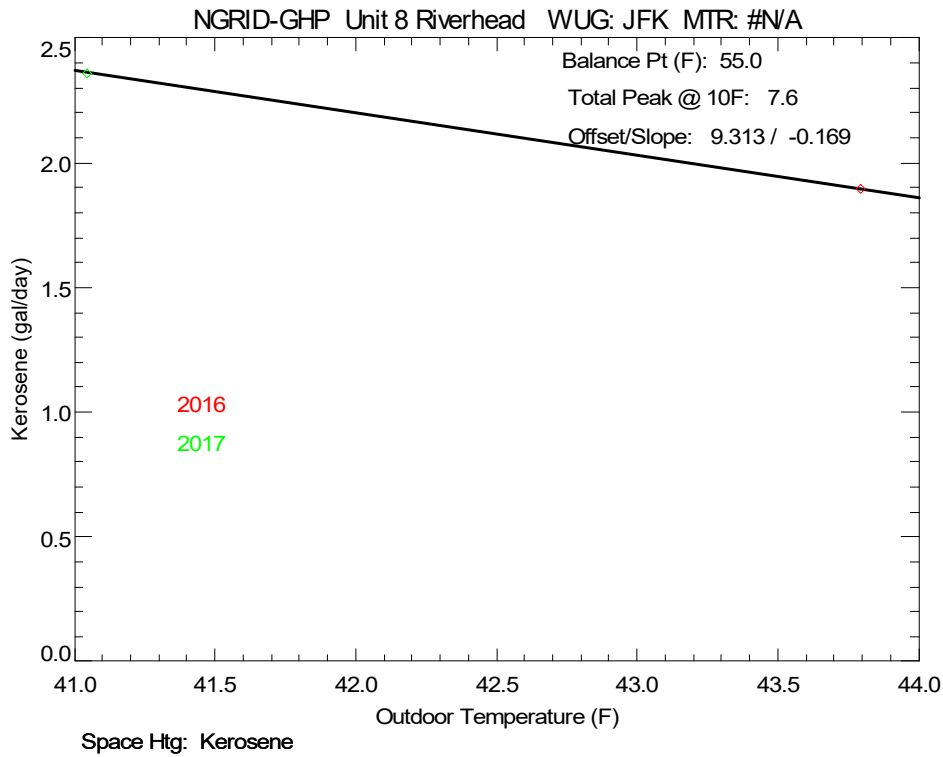
**Figure A-3. Fuel Delivery Logs vs. Outdoor Temperature for Site 6**



**Figure A-4. Fuel Delivery Logs vs. Outdoor Temperature for Site 7**



**Figure A-5. Fuel Delivery Logs vs. Outdoor Temperature for Site 8**



**Figure A-6. Fuel Delivery Logs vs. Outdoor Temperature for Site 9**

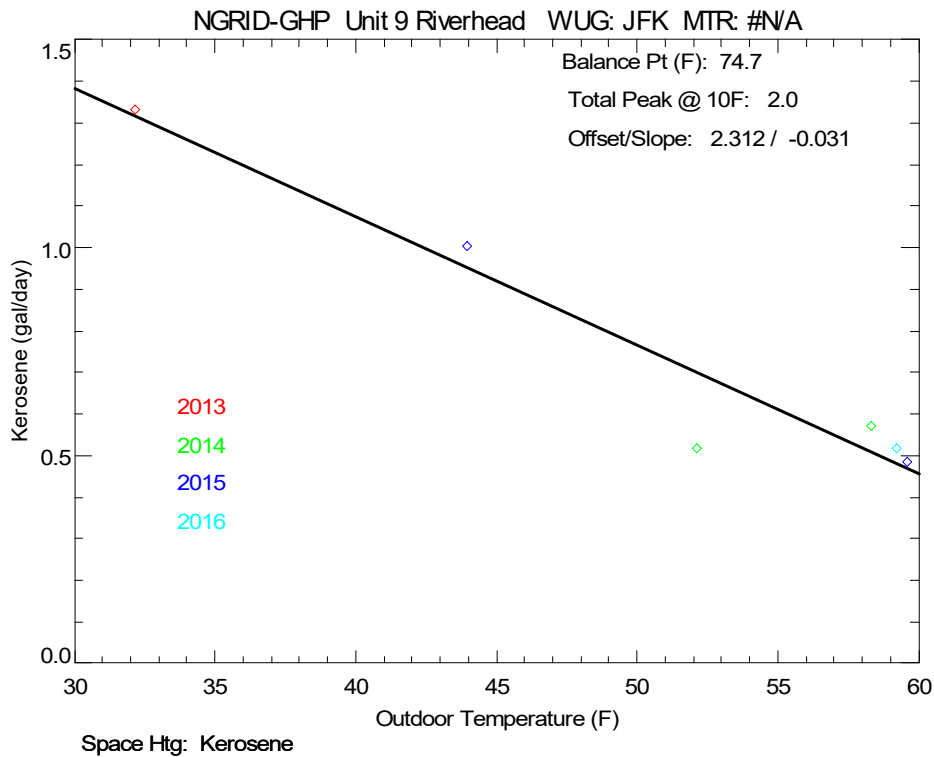
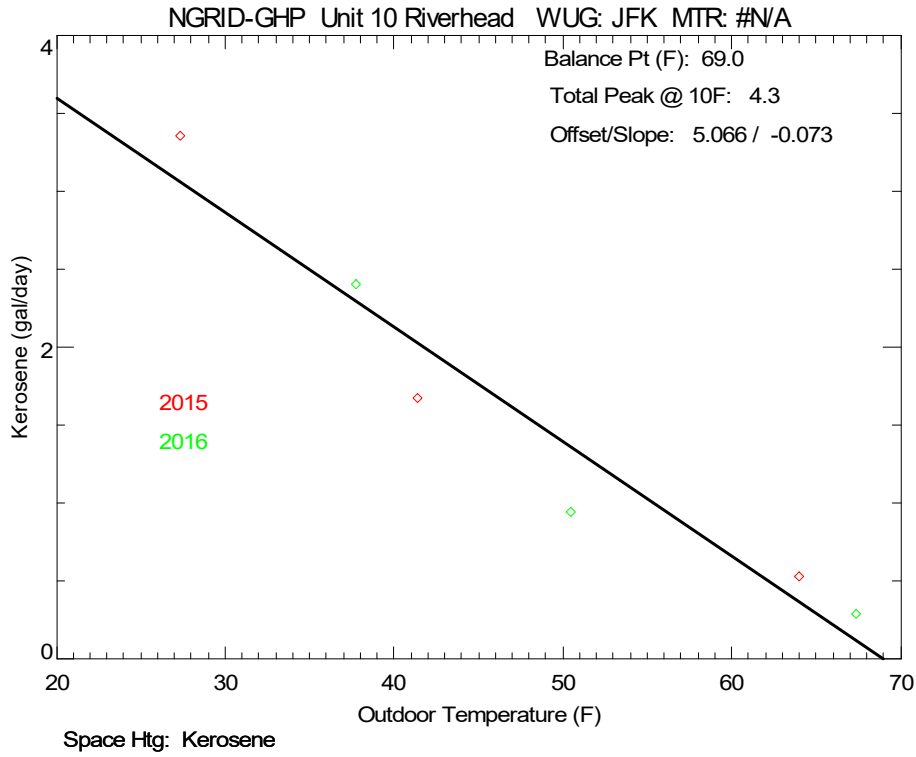


Figure A-7. Fuel Delivery Logs vs. Outdoor Temperature for Site 10



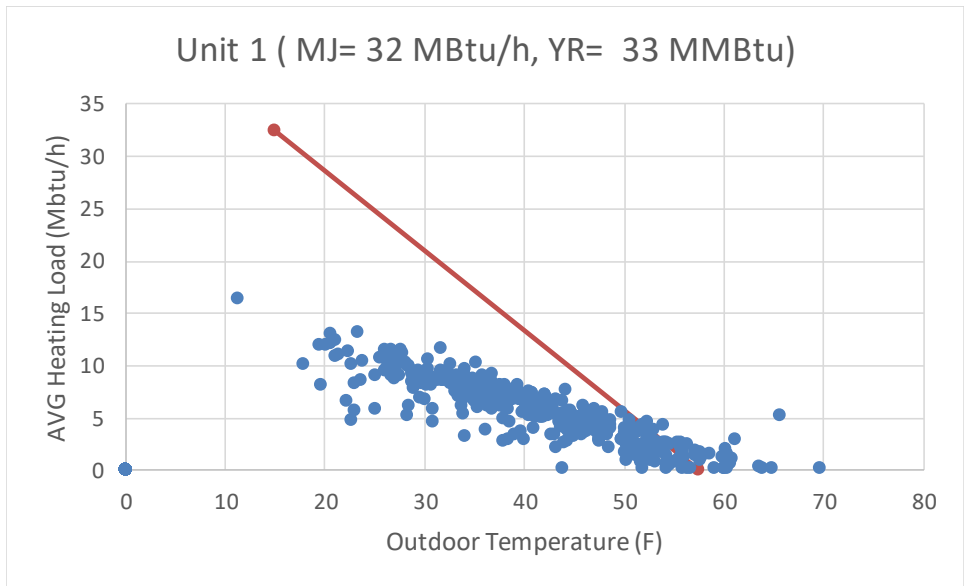
## Appendix B: Comparing Measured Heating Load Data to Manual J Peak Loads

---

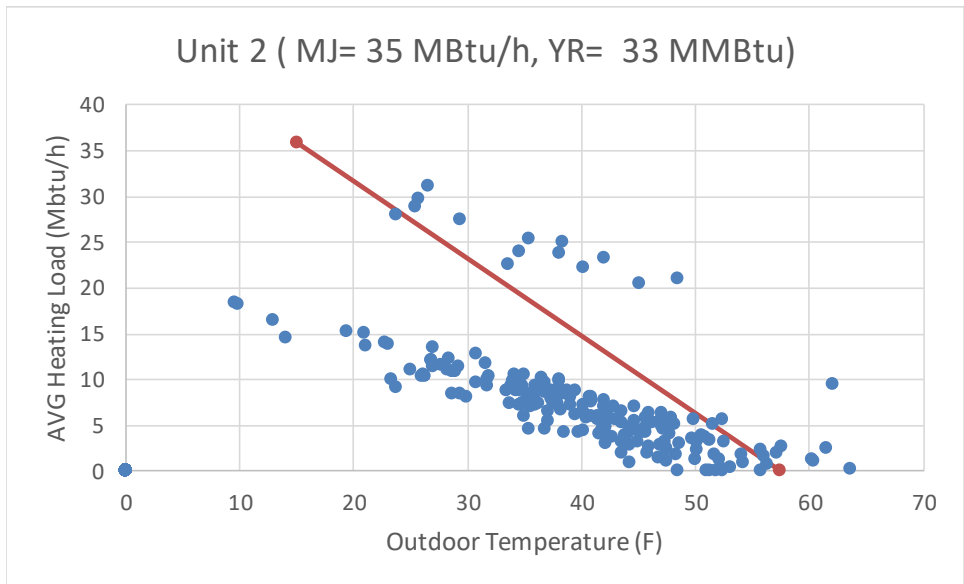
This appendix compares the measured heating load data to the load lines implied by the calculated Manual J heating load (Figures B-1 to B-10). The heating load data are the daily total values (MBtu/day) converted to an average rate across the day (MBtu/h) and then plotted against the daily average temperatures. The line uses the Manual J heating load reported by the HVAC contractor which were presumably calculated at the local 1% design temperature (e.g., 15°F for JFK airport). The load line assumes the heating load goes to zero at an outdoor temperature (or balance point) of 57.5°F. The title of each plot gives the Manual J heating load (MJ) in MBtu/h as well as the annual heating load for the year (YR) in MMBtu.

Generally, the Manual J design loads over-predicted the heating loads compared to the measured data. Some of this difference may be explained by the fact that Manual J load calculations do not consider internal gains in the homes. The real homes have internal gains from occupants and electric consumption. It is also possible that the HVAC contractor under predicted the impact of the weatherization improvements implemented in each home. It is also noteworthy that while the Manual J peak loads range from 30 to 39 MBtu/h, the floor areas range from 900 to 1600 square feet. It is possible that the Manual J calculations did not accurately represent the actual thermal characteristics of each building.

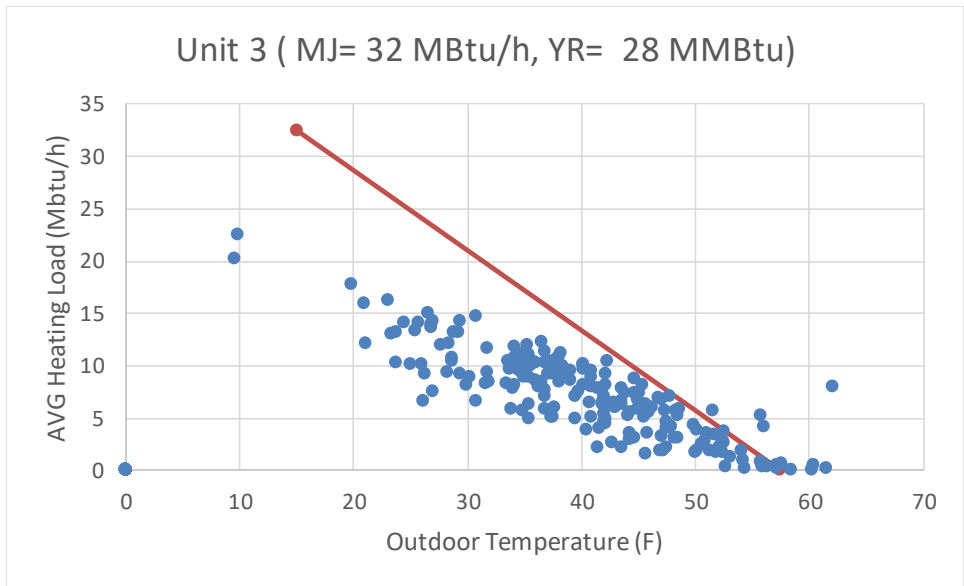
**Figure B-1. Daily Heating Load Data Compared to Load Line Implied by Manual J Load - HP1**



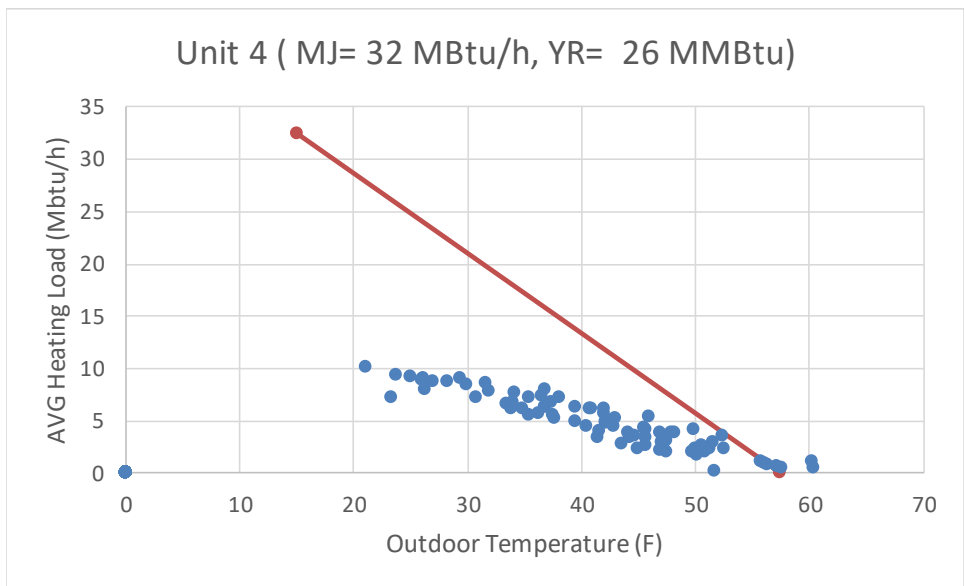
**Figure B-2. Daily Heating Load Data Compared to Load Line Implied by Manual J Load - HP2**



**Figure B-3. Daily Heating Load Data Compared to Load Line Implied by Manual J Load - HP3**

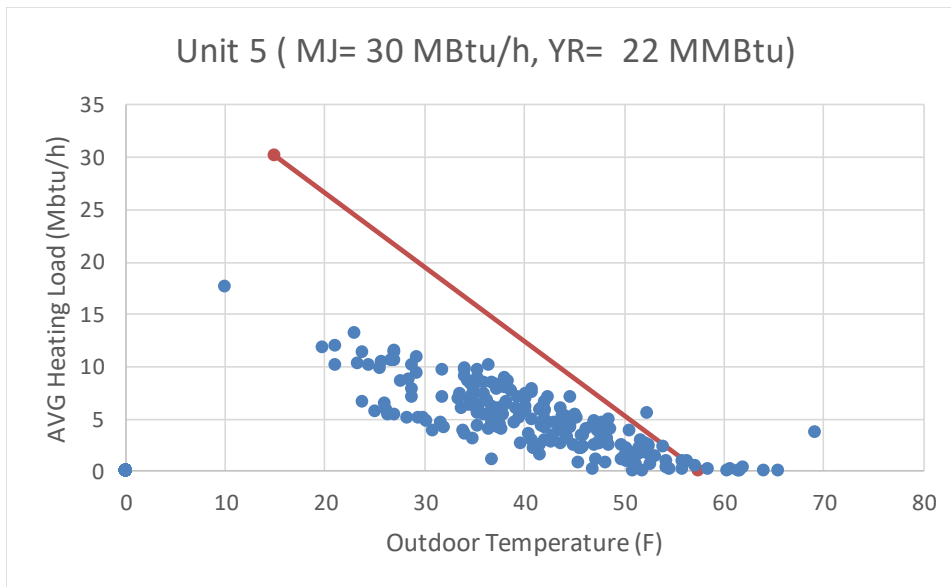


**Figure B-4. Daily Heating Load Data Compared to Load Line Implied by Manual J Load - HP4**

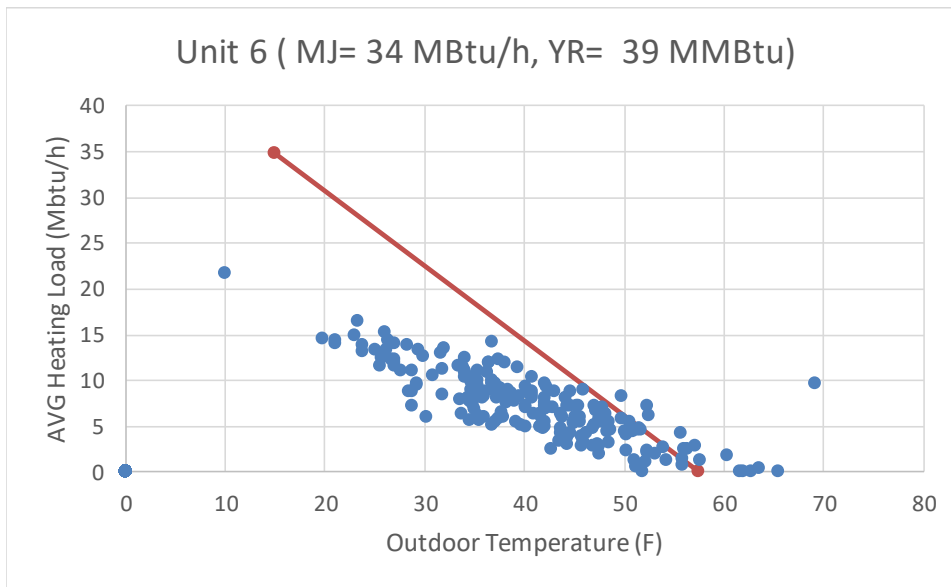




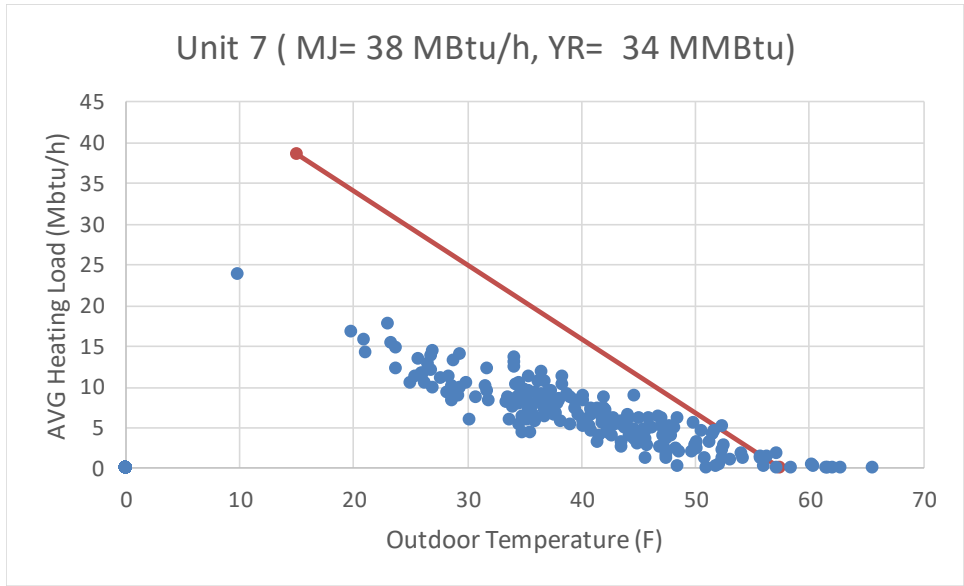
**Figure B-5. Daily Heating Load Data Compared to Load Line Implied by Manual J Load - HP5**



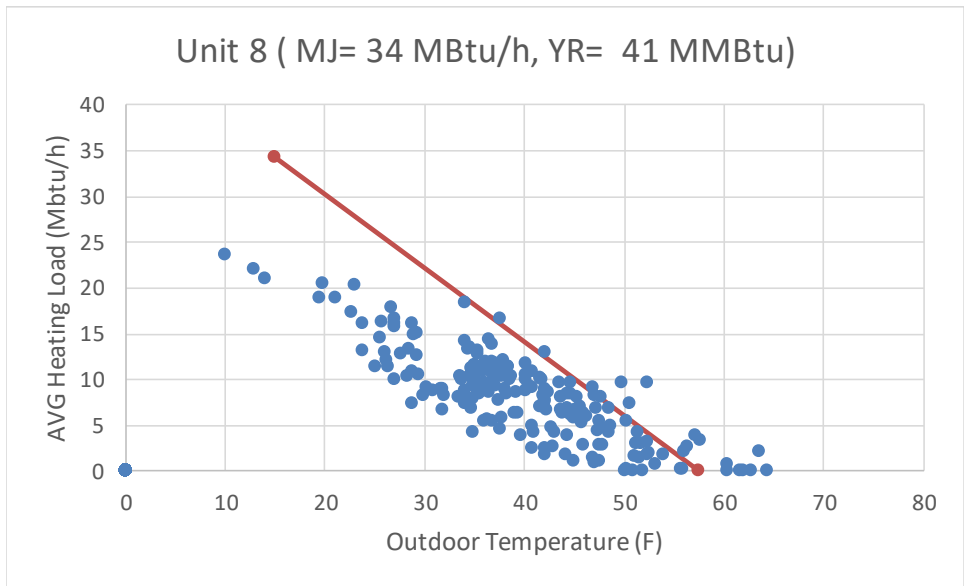
**Figure B-6. Daily Heating Load Data Compared to Load Line Implied by Manual J Load - HP6**



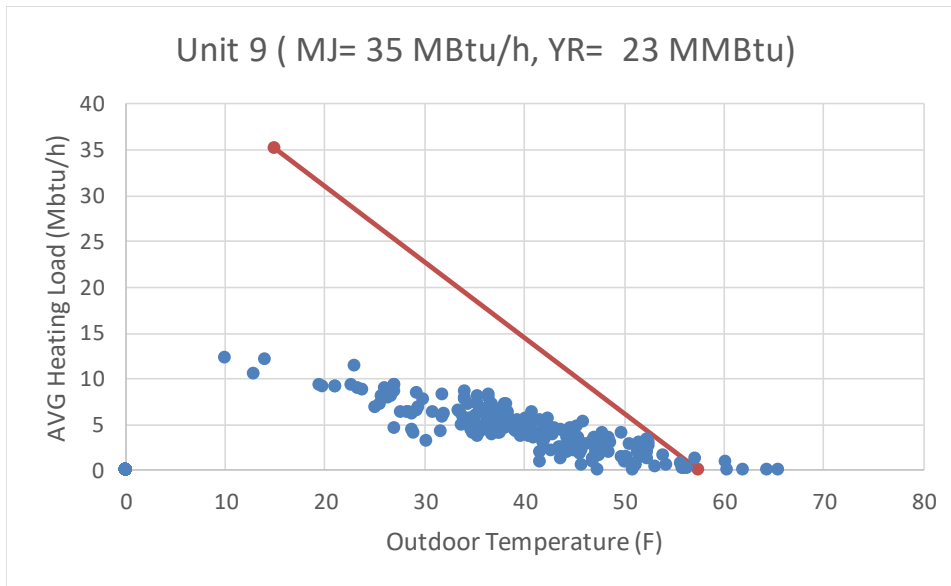
**Figure B-7. Daily Heating Load Data Compared to Load Line Implied by Manual J Load - HP7**



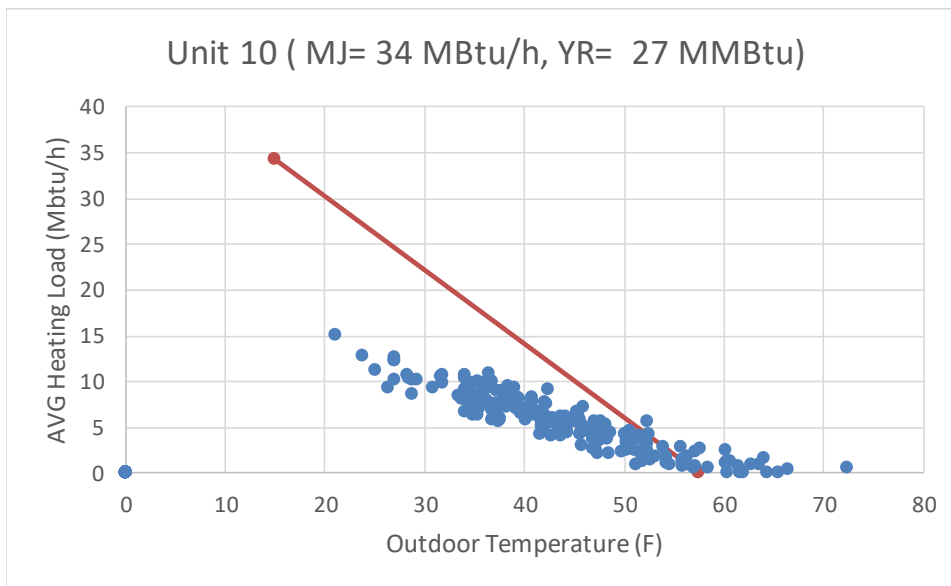
**Figure B-8. Daily Heating Load Data Compared to Load Line Implied by Manual J Load - HP8**



**Figure B-9. Daily Heating Load Data Compared to Load Line Implied by Manual J Load - HP9**



**Figure B-10. Daily Heating Load Data Compared to Load Line Implied by Manual J Load - HP10**



# Appendix C: Comparing Measured HP Performance to Manufacturers Data

## C.1 Steady State HP Performance

As a check on the validity of the measured data, we compared measured steady state performance to the manufacturer’s published performance data. The manufacturers data for the XT036 unit are given below. The performance data includes, HC, the heating capacity at 70°F entering w/o fan Watts. COP is also without fan Watts.

**Table C-1. Manufacturer’s Steady State Performance Data for XT series packaged unit**

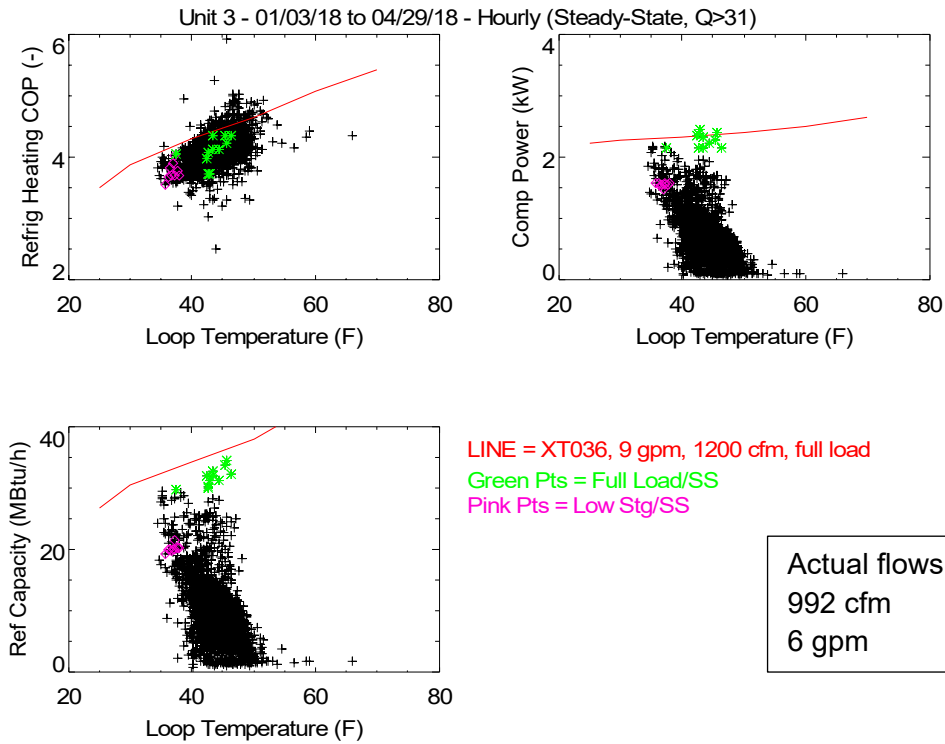
MODEL 036, 3 TON, FULL LOAD HEATING PERFORMANCE DATA:

EWT °F	Flow GPM	WPD		LWT °F	Heating									
		PSI	FT		Airflow CFM	LAT °F	HC MBtuh	HE MBtuh	COP W/W	Discharge PSIG	Suction PSIG	Subcooling °F	Superheat °F	
25	9.0	4.1	9.4	20.6	1200	90.7	26.8	19.2	2.24	3.51	295.3	66.3	23.1	8.3
				20.5	1350	88.6	27.1	19.5	2.24	3.55	295.3	66.1	23.1	8.4
30	4.5	1.4	3.2	20.3	1200	92.4	29.0	21.2	2.29	3.71	304.6	68.8	28.2	7.9
				20.1	1350	90.1	29.3	21.5	2.29	3.75	304.6	68.7	28.2	8.0
	7.0	2.8	6.6	23.3	1200	93.5	30.5	22.6	2.31	3.87	308.2	74.9	25.7	6.7
				23.3	1350	91.1	30.8	22.9	2.31	3.91	308.2	74.8	25.7	6.7
9.0	4.0	9.1	24.8	1200	93.5	30.5	22.7	2.30	3.89	307.4	77.4	23.5	5.6	
			24.8	1350	91.1	30.7	22.9	2.30	3.91	307.4	77.3	23.5	5.7	
40	4.5	1.3	2.9	28.7	1200	95.2	32.6	24.6	2.34	4.08	314.9	83.7	25.0	6.3
				28.6	1350	92.6	32.9	24.9	2.34	4.12	314.9	83.5	25.0	6.4
	7.0	2.6	6.0	32.3	1200	96.5	34.3	26.2	2.36	4.26	318.7	91.1	22.2	5.7
				32.2	1350	93.7	34.6	26.5	2.36	4.30	318.7	90.9	22.2	5.8
9.0	3.6	8.3	34.0	1200	96.5	34.3	26.3	2.34	4.30	317.8	94.2	19.8	4.7	
			33.9	1350	93.7	34.5	26.5	2.34	4.32	317.8	94.0	19.8	4.8	
50	4.5	1.2	2.7	37.1	1200	98.1	36.4	28.2	2.40	4.44	326.5	99.0	22.2	5.7
				36.9	1350	95.2	36.7	28.5	2.40	4.48	326.5	98.8	22.2	5.8
	7.0	2.4	5.5	41.2	1200	99.5	38.2	29.9	2.42	4.63	330.4	107.9	19.1	5.7
				41.1	1350	96.4	38.5	30.2	2.42	4.66	330.4	107.6	19.1	5.8
9.0	3.3	7.6	43.1	1200	99.5	38.2	30.0	2.40	4.66	329.5	111.5	16.5	4.9	
			43.1	1350	96.4	38.5	30.3	2.40	4.70	329.5	111.2	16.5	5.0	
60	4.5	1.1	2.5	44.9	1200	102.0	41.5	33.0	2.50	4.86	345.7	117.2	21.3	5.1
				44.7	1350	98.7	41.9	33.4	2.50	4.91	345.7	116.9	21.3	5.2
	7.0	2.2	5.0	49.7	1200	103.6	43.6	35.0	2.52	5.07	349.9	127.6	18.0	5.8
				49.6	1350	100.2	44.0	35.4	2.52	5.12	349.9	127.3	18.0	6.0
9.0	3.0	7.0	52.0	1200	103.6	43.6	35.0	2.51	5.09	348.9	131.8	15.2	5.2	
			51.9	1350	100.1	43.9	35.3	2.51	5.13	348.9	131.5	15.2	5.3	

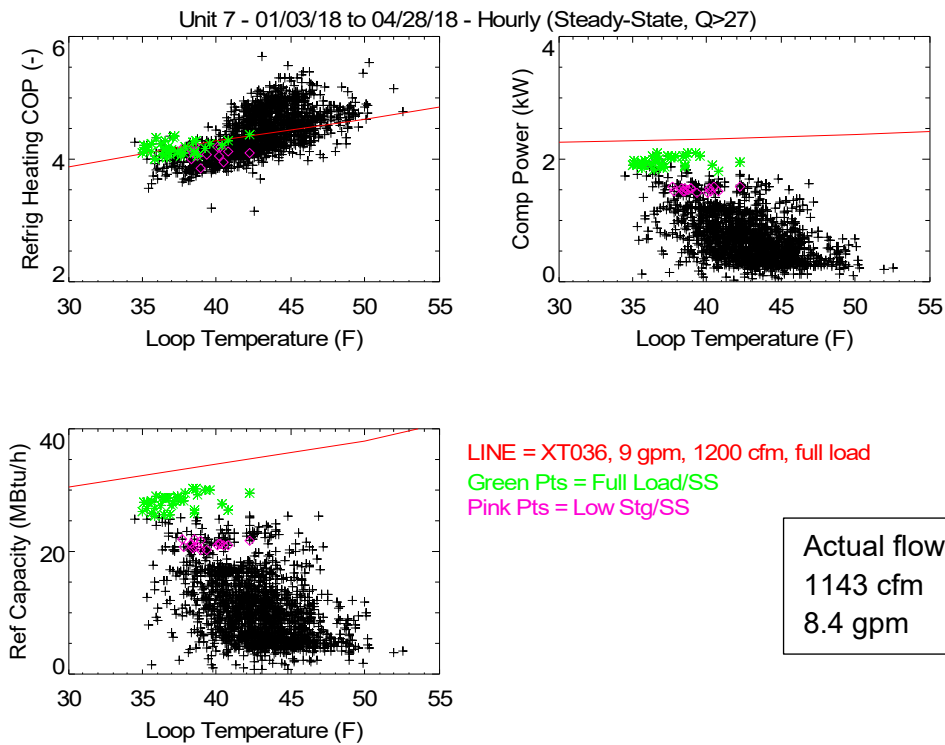
20D214-04NN XT, Rev.: A

For this comparison, we focused on the XT series package units since these heat pumps are factory-charged with refrigerant. The split units (RT series) were charged in the field (and there could have been errors in this process). Figure C-1 and C-2 show that the green data points – which represent hours with continuous operation at full load. The measured heating capacity and COP were calculated with equations 3 & 4 from Section 3 of the report. The red line represents the manufacturers data. The measured performance data at steady state are in approximate agreement with the manufacturers data. Some of the variation may be explained by the slight differences in the actual airflow and loop flow compared to the manufacturer’s table.

**Figure C-1. Comparing Measured Steady State Performance to Manufacturer's Data for HP3**



**Figure C-2. Comparing Measured Steady State Performance to Manufacturer's Data for HP7**



## C.1 Theoretical Impact of One Stage Pumping

This section uses the published data (Table C-1) from the manufacturer to theoretically show the impact of constant speed pumping on a dual stage heat pump unit. The AHRI-rated part load COP (4.6) is higher than the rated full load COP (4.2) for this dual stage unit, mostly due to the different entering water temperatures. However, the COPs for full and part load are fairly similar at the same operating condition. In this case the low stage COP is actually lower at 40°F.

The table applies different levels of pumping power to demonstrate the impact on Net Heating COP. At any level of pumping power, the high stage COP is more than 10% better than the low stage COP.

**Table C-2. Impact of Constant Speed Pump Operation on High- and Low-Stage COPs**

20D214-04NN XT, Rev.: A						Pumping Power (kW)				Relative Pumping Power
Catalog Data			Fan Power (IW)	Net Heating COP						
Rated COP	COP at 40F	Heat Capacity (Mbtu/h)		Unit Power (kW)	0.15	0.25	0.35	0.45		
Low 1050 cfm / 6 gpm	4.6 at 41F	3.92	23.6	1.76	0.32	3.24	3.10	2.98	2.86	100%
High 1200 cfm / 9 gpm	4.2 at 32F	4.30	34.3	2.34	0.42	3.60	3.48	3.37	3.26	100%
						11%	12%	13%	14%	

# Appendix D: Variations in Pump and Fan Operation and Fan-Compressor Operating Patterns

---

## D.1 Trend of Loop Flow, Pump Power and Fan Power

The plots on pages D-2 to D-4 show the trends of loop flow, pumping power and fan power across the entire monitoring period. These plots were used to detect changes in the loop flow or airflows. Table D-1 summarizes the observed loop flow changes observed across the period.

**Table D-1. Changes in Loop Flow Rates**

Unit	Change in Loop Flow
HP3	Dropped from 12 to 6 gpm on March 10, 2018 Increased from 7 to 9 gpm on June 20, 2018
HP4	Increased from 10 to 13 gpm on May 30, 2018 Decreased from 13 to 10 gpm on June 20, 2018
HP5	Increased from 7 to 12 gpm on February 1, 2019

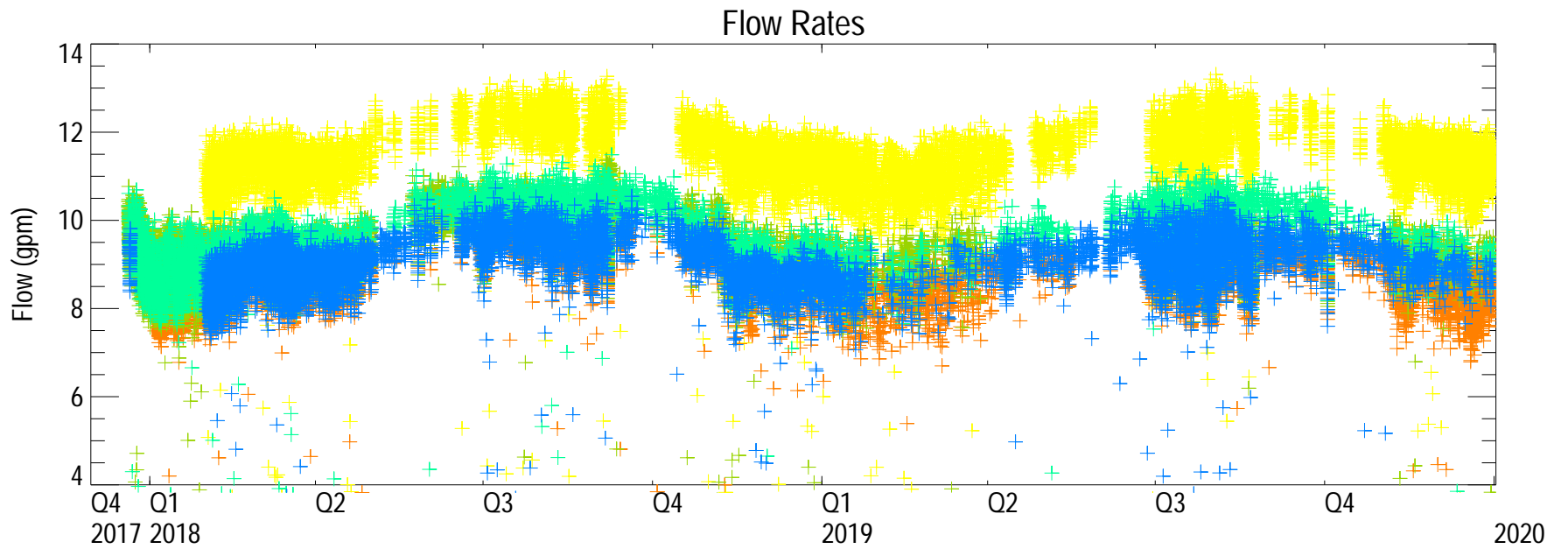
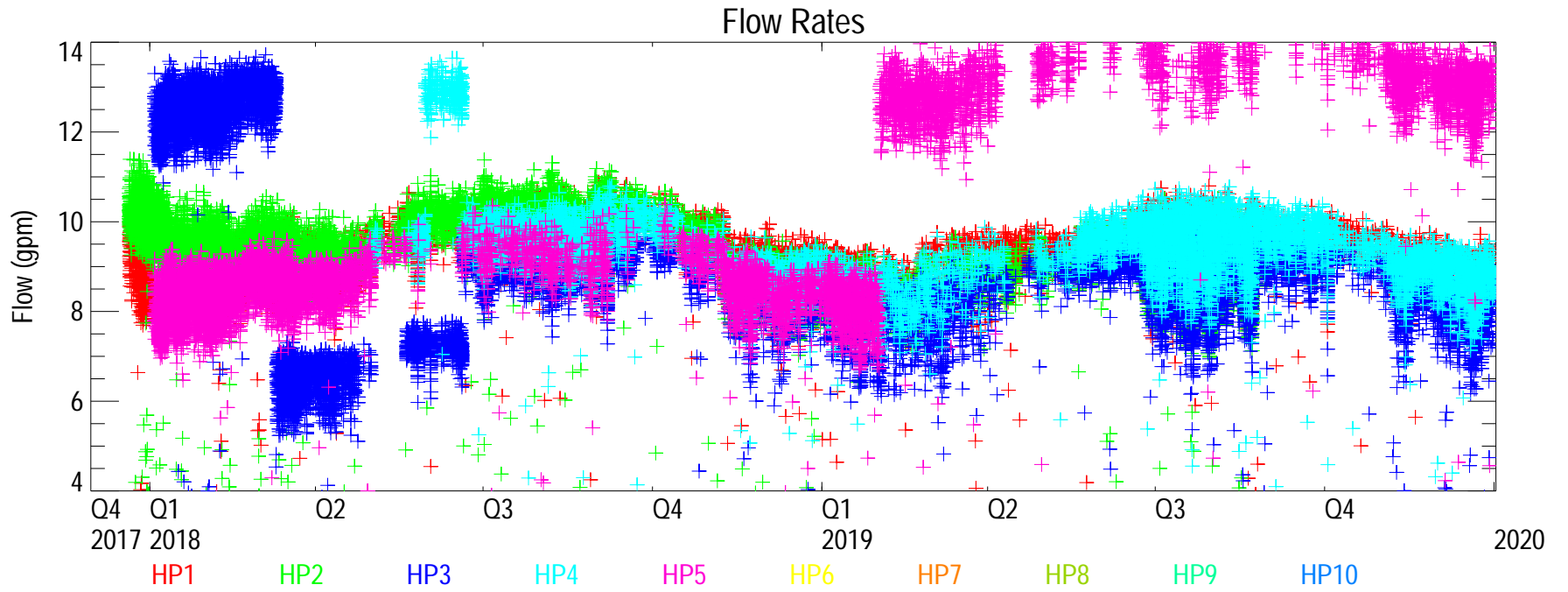
The loop flow data also confirm the expected trend of loop flow changing with fluid temperatures across the year. In the winter months, the loop fluid is around 40°F and the higher viscosity results in a lower flow compared to the summer when loop temperatures are closer to 65°F. The winter-to-summer flow variations are typically 1-2 gpm.

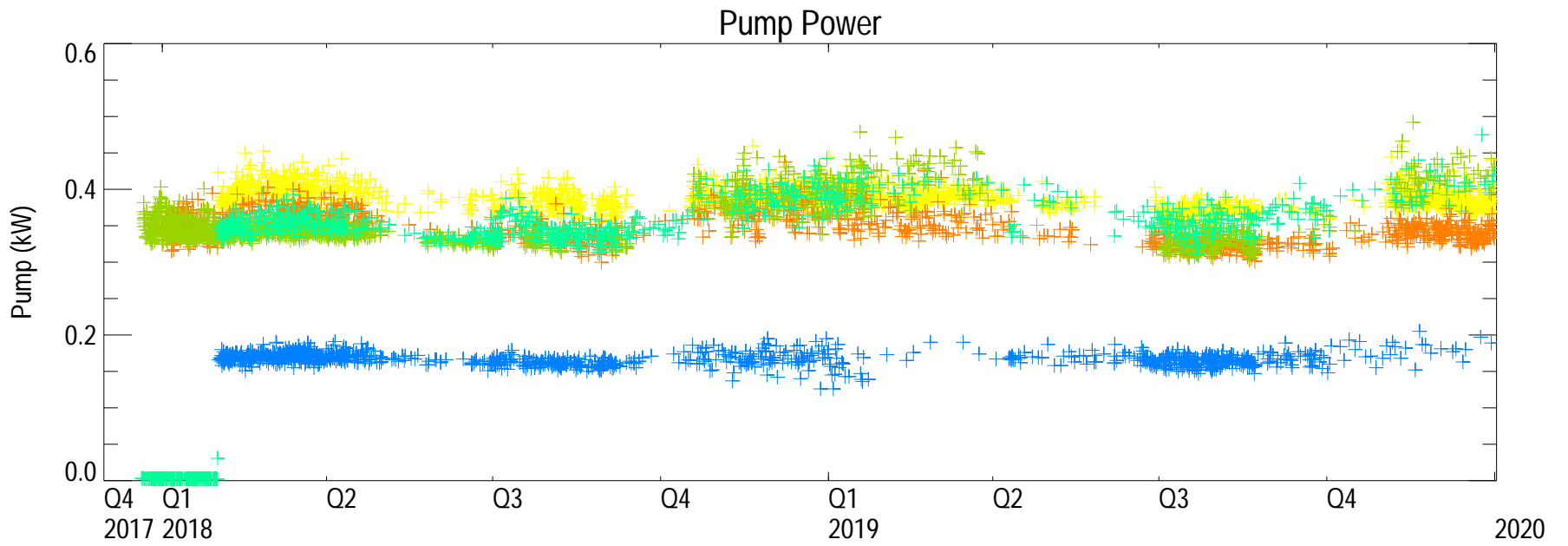
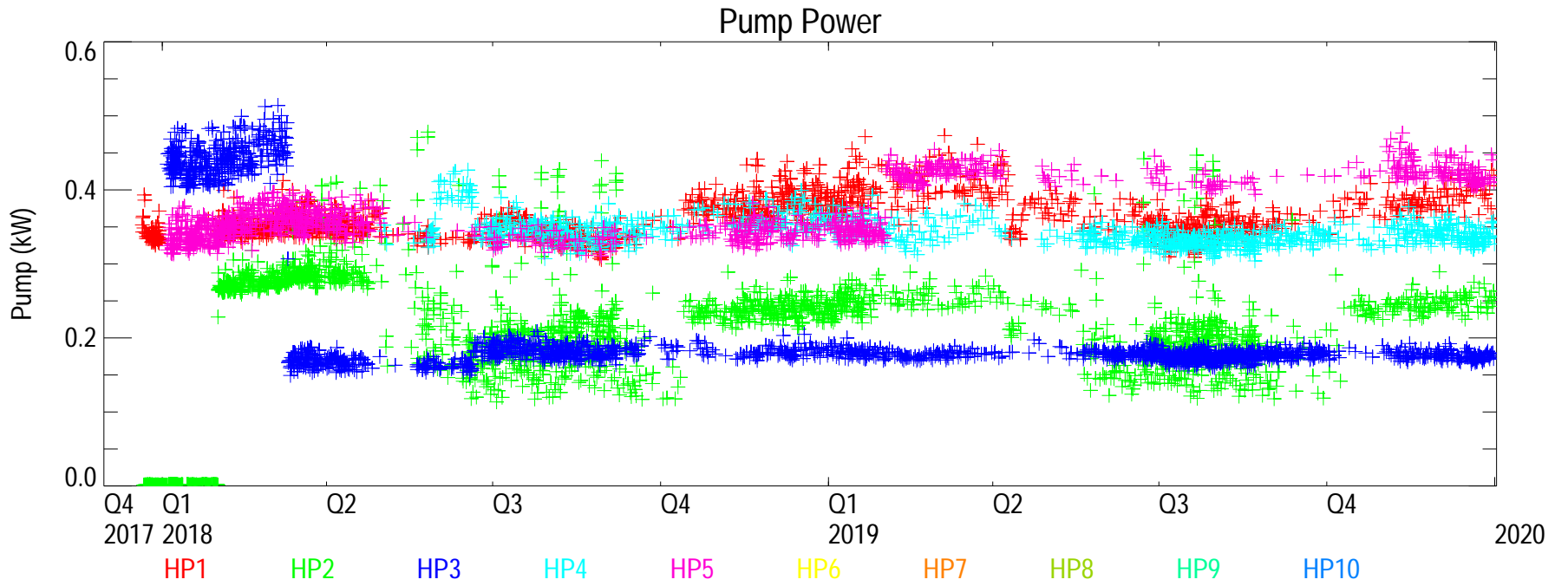
## D.2 Operating Patterns for Compressor and Fan Power

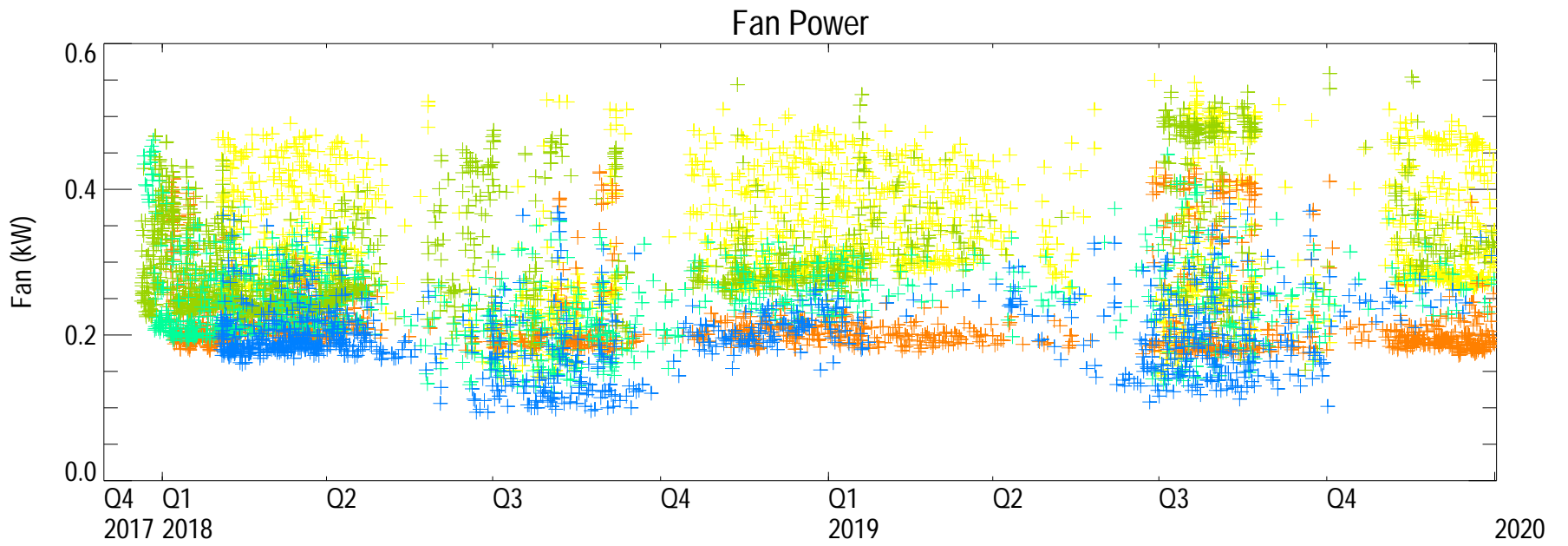
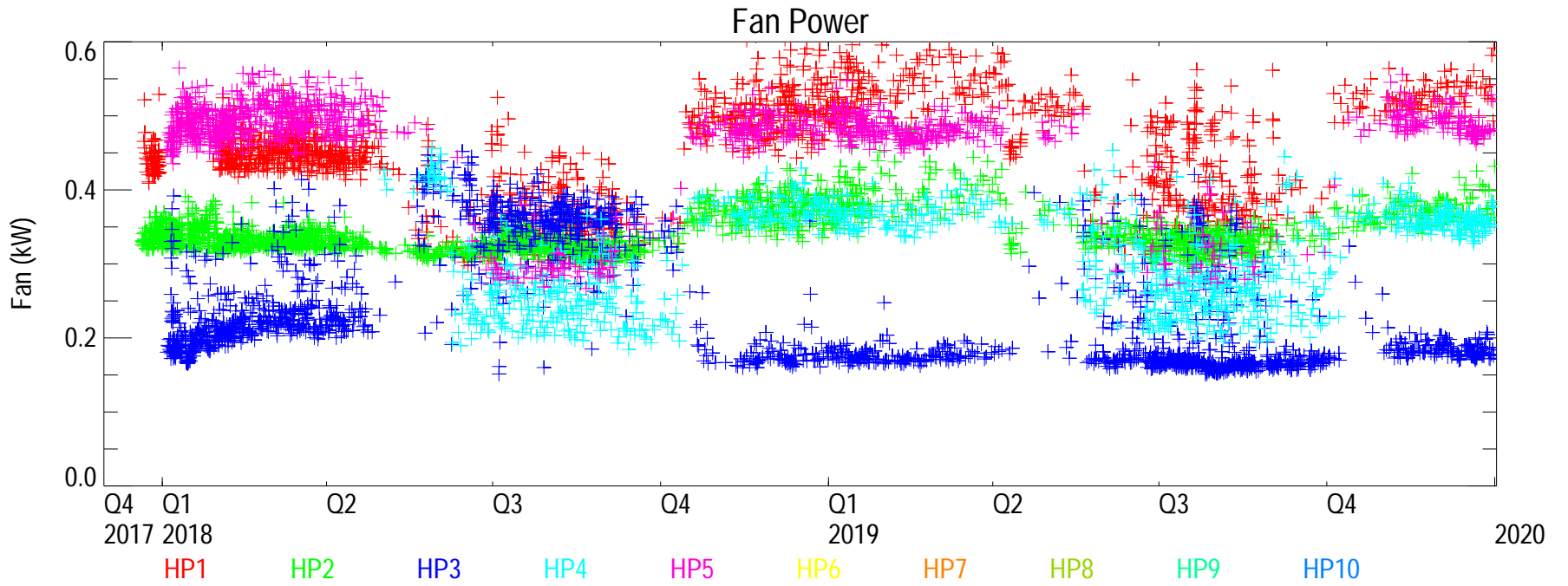
The shade plots on pages D-5 to D-14 compare the patterns of fan and compressor power for HP1 to HP10 over a one-month period (for December 2018). Each day is represented as a vertical stripe on the plot. Subsequent days are shown along x-axis. Each 5-minute interval is shown with a shade of gray. Darker shades indicate more power use and light gray indicates zero use. The maximum and minimum power is listed at the bottom of each plot. Intervals with missing data is indicated as white. These plots show:

- The pattern of thermostat setback used by some homeowners (HP1, HP6 and HP9) as indicated by the consistent increase in compressor energy use in early morning hours.
- The similar operating patterns for compressor power and fan power indicate that the fan always cycled on and off with the compressor. This fan operating pattern was observed across all months (except for the first couple weeks of operation on HP4 in May 2018).

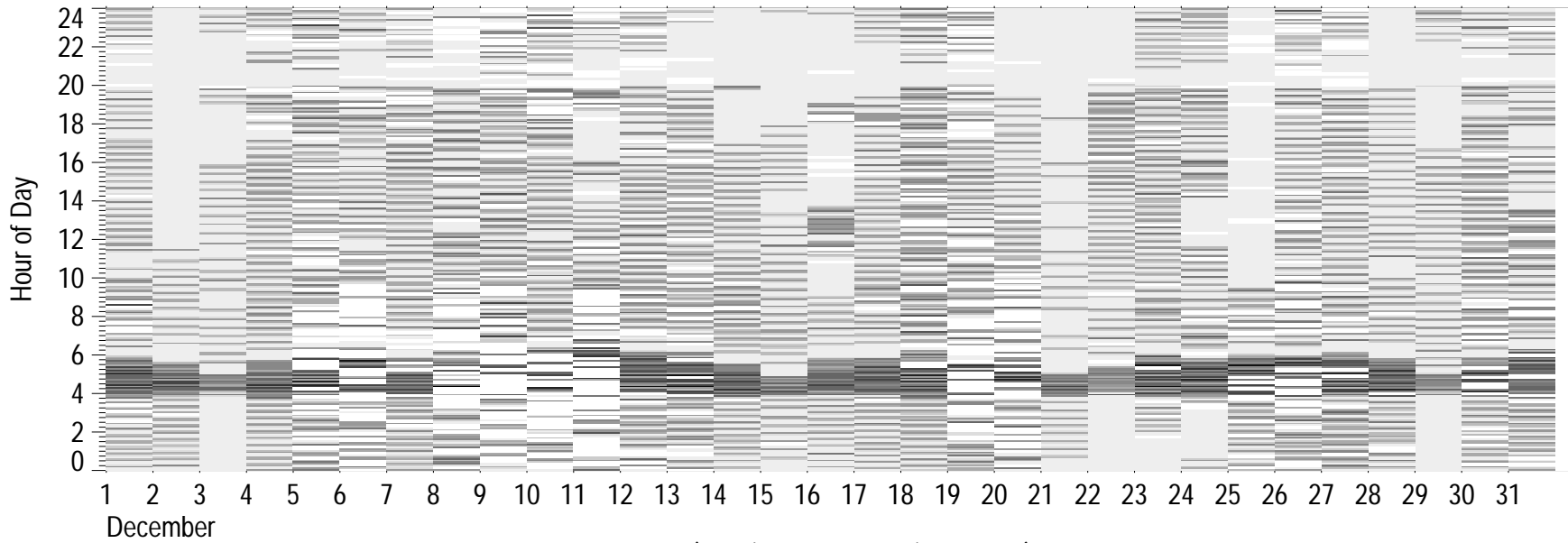




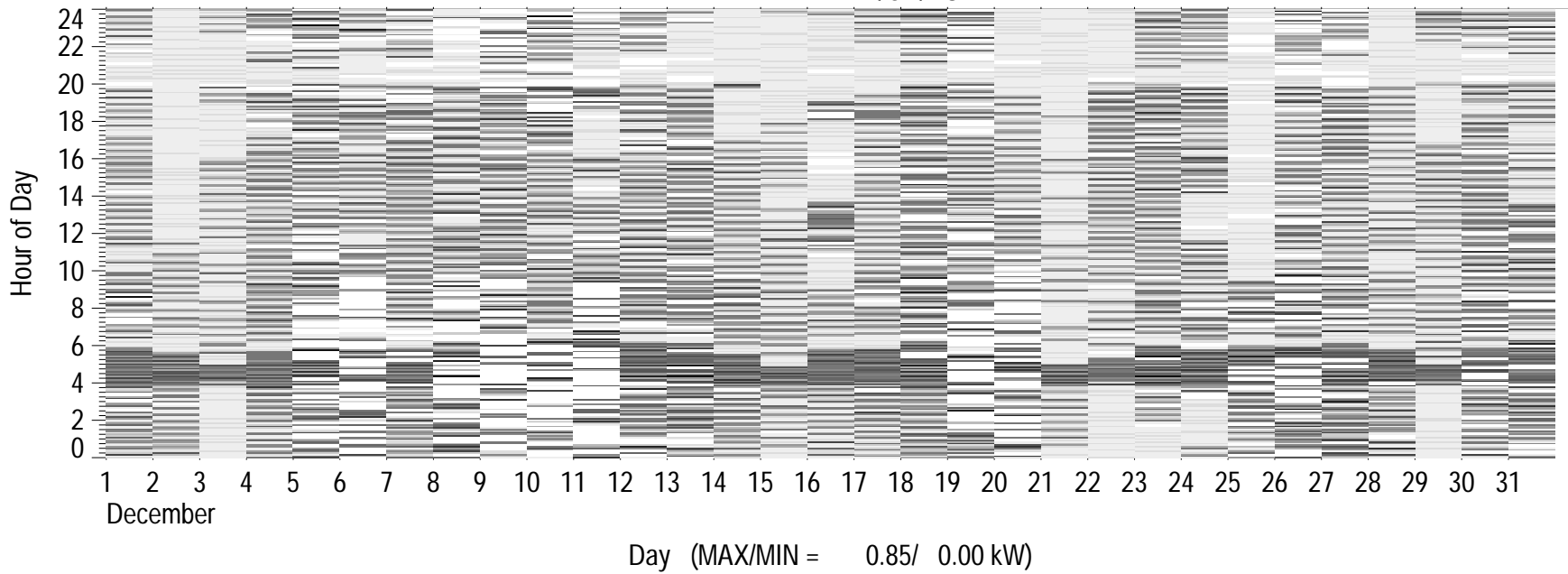




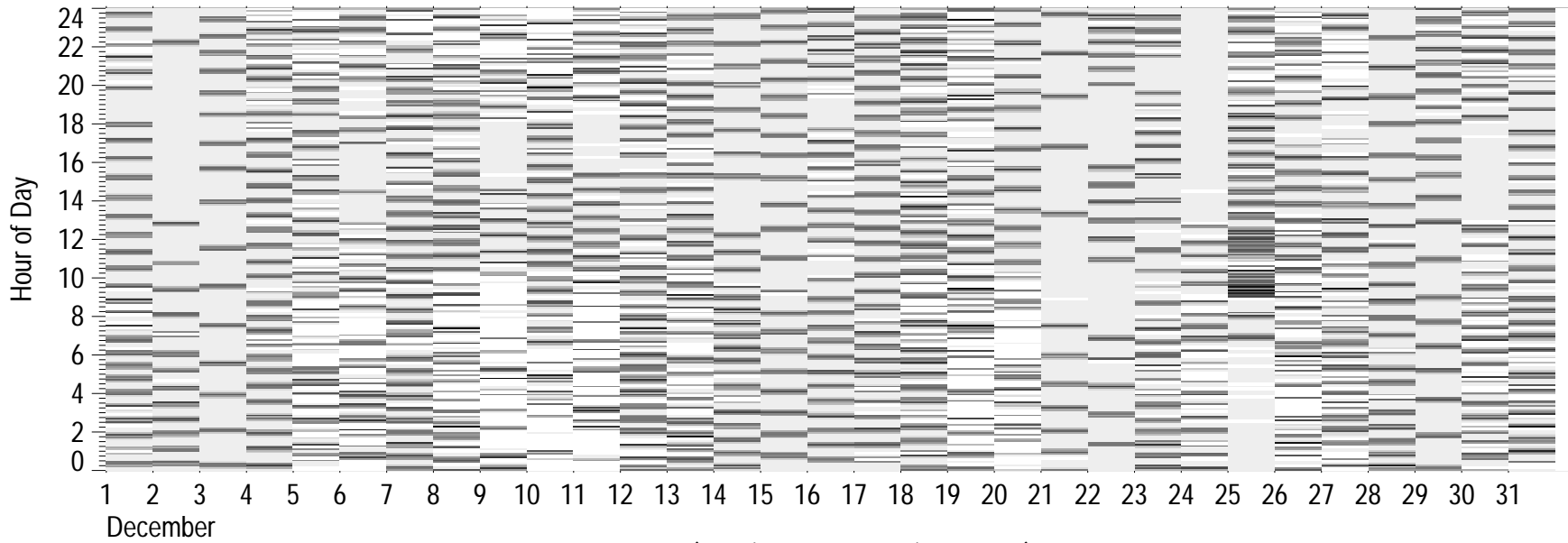
WC: HP1 12/01/18



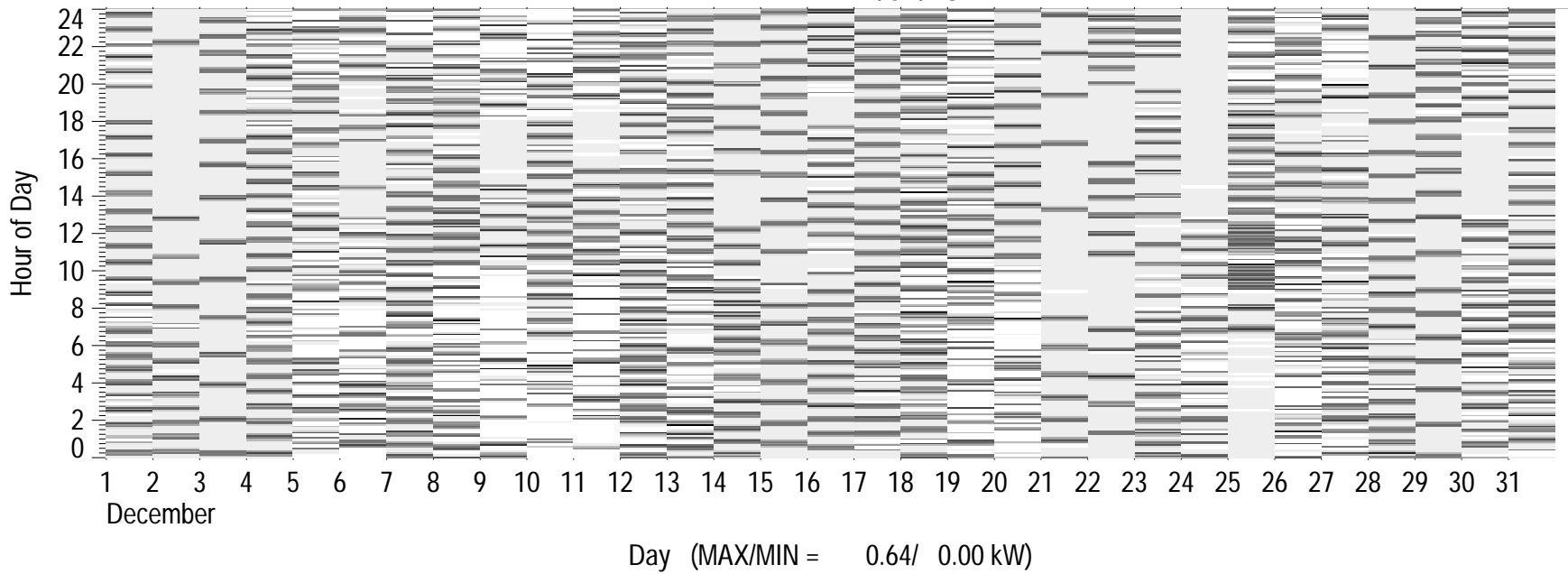
WF: HP1 12/01/18



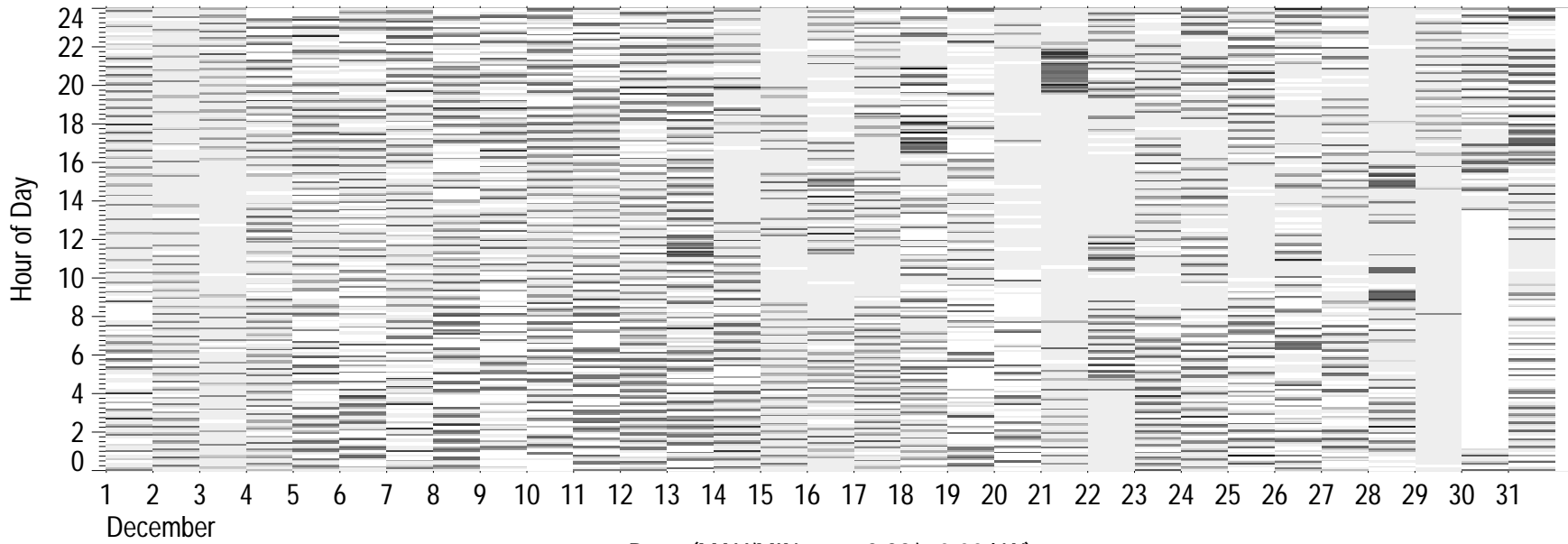
WC: HP2 12/01/18



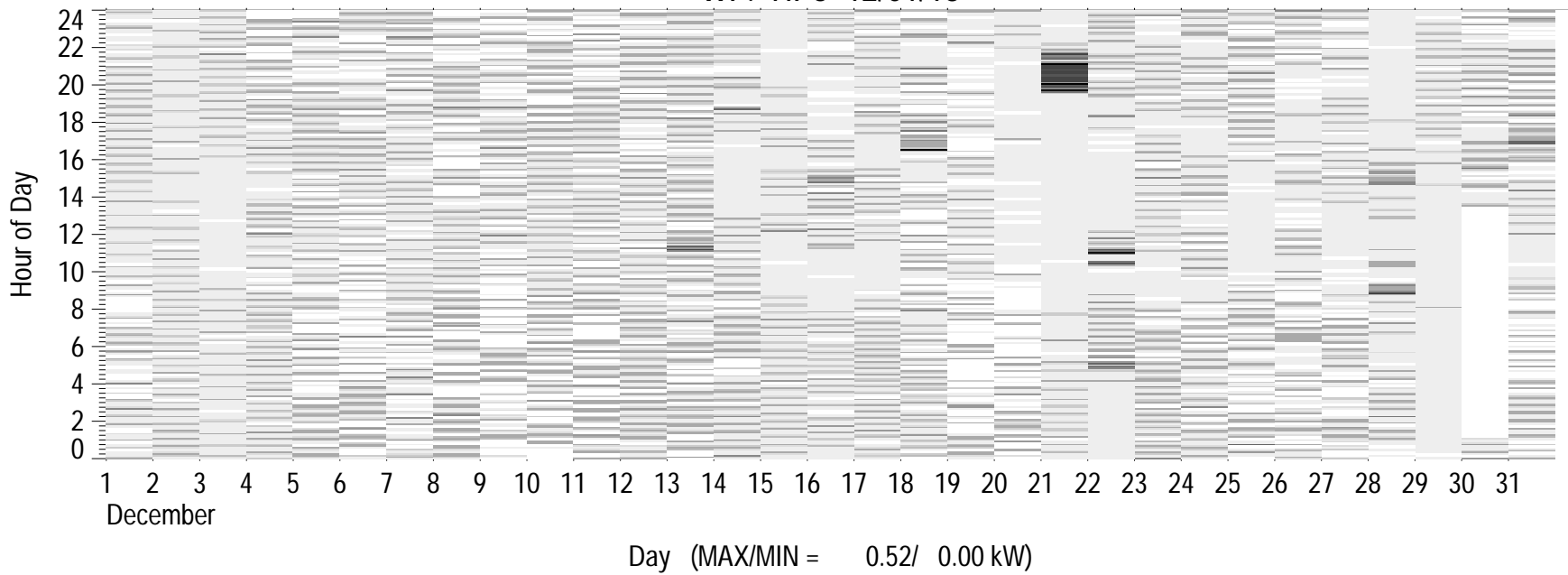
WF: HP2 12/01/18



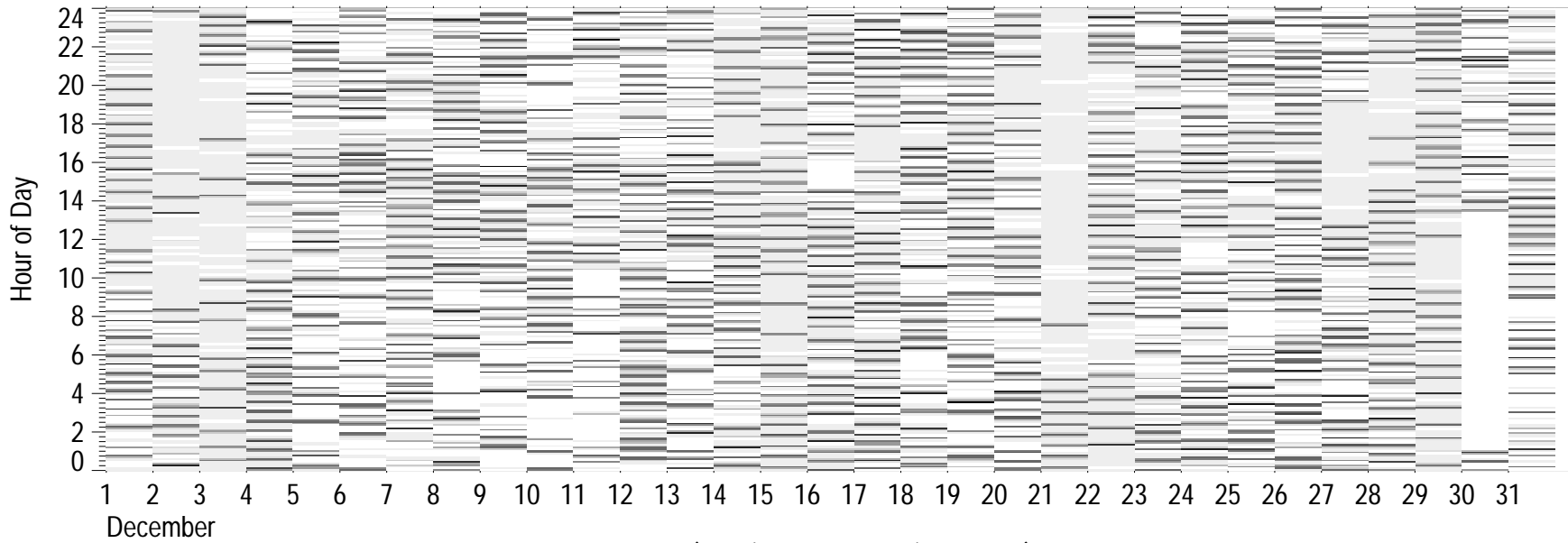
WC: HP3 12/01/18



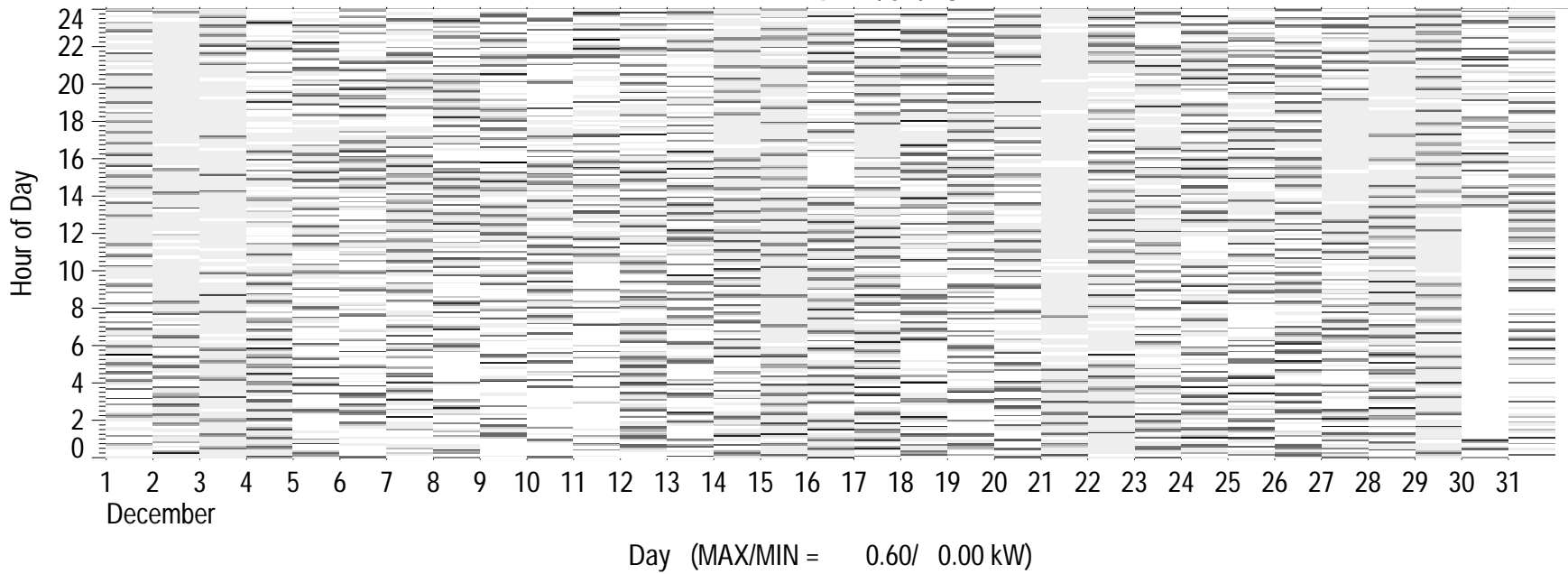
WF: HP3 12/01/18



WC: HP4 12/01/18

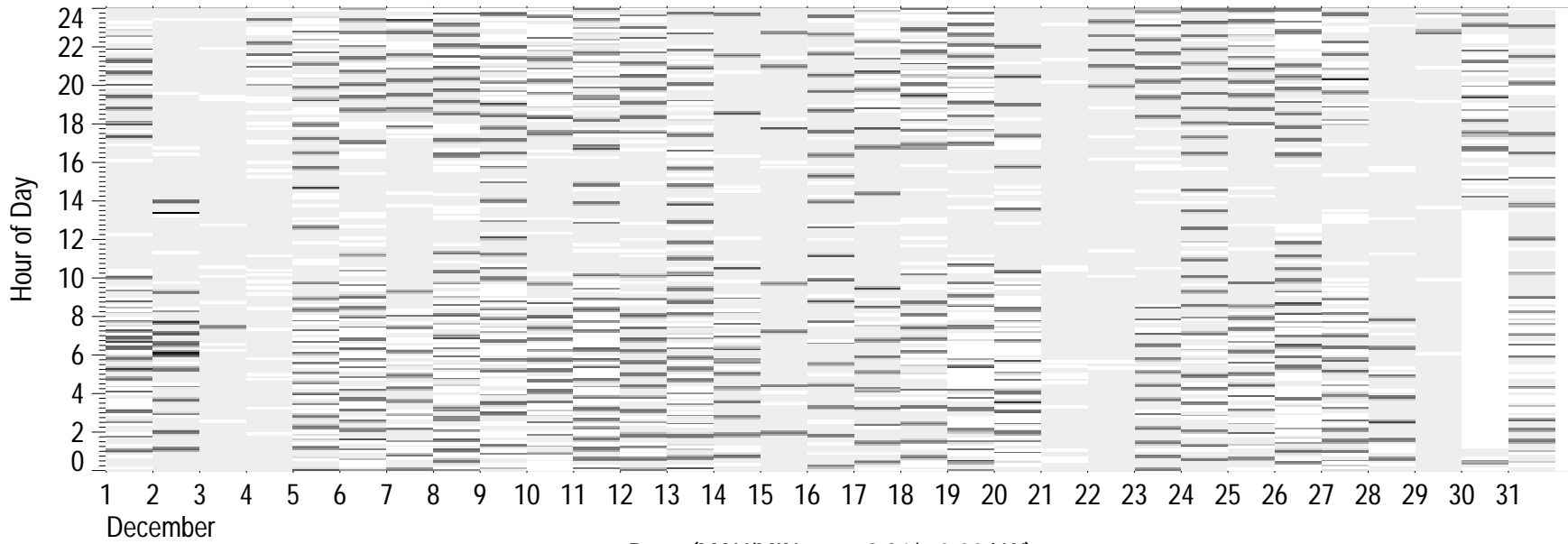


WF: HP4 12/01/18

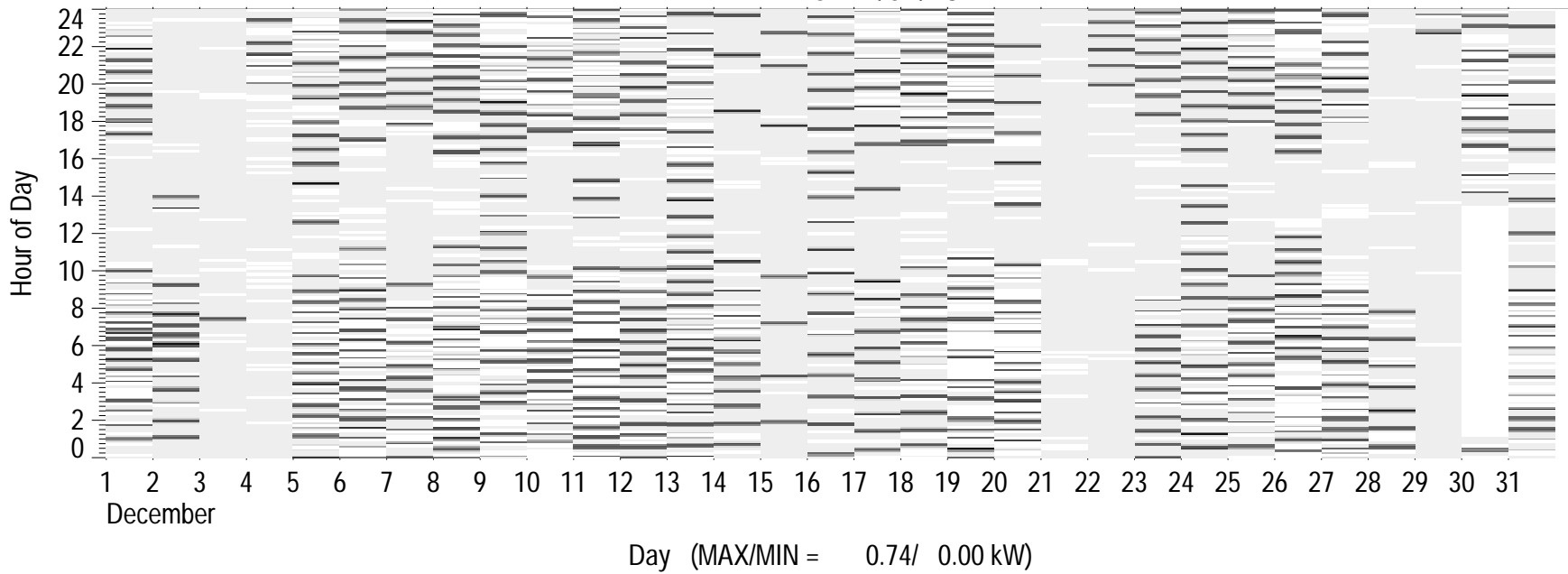




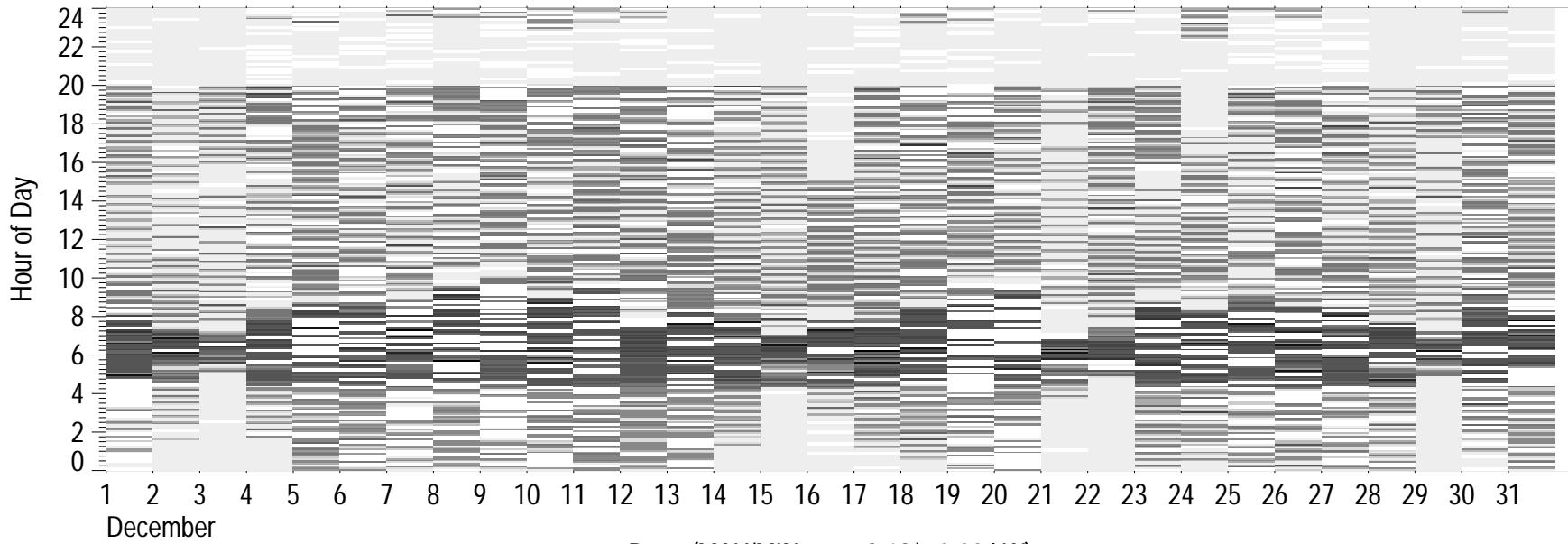
WC: HP5 12/01/18



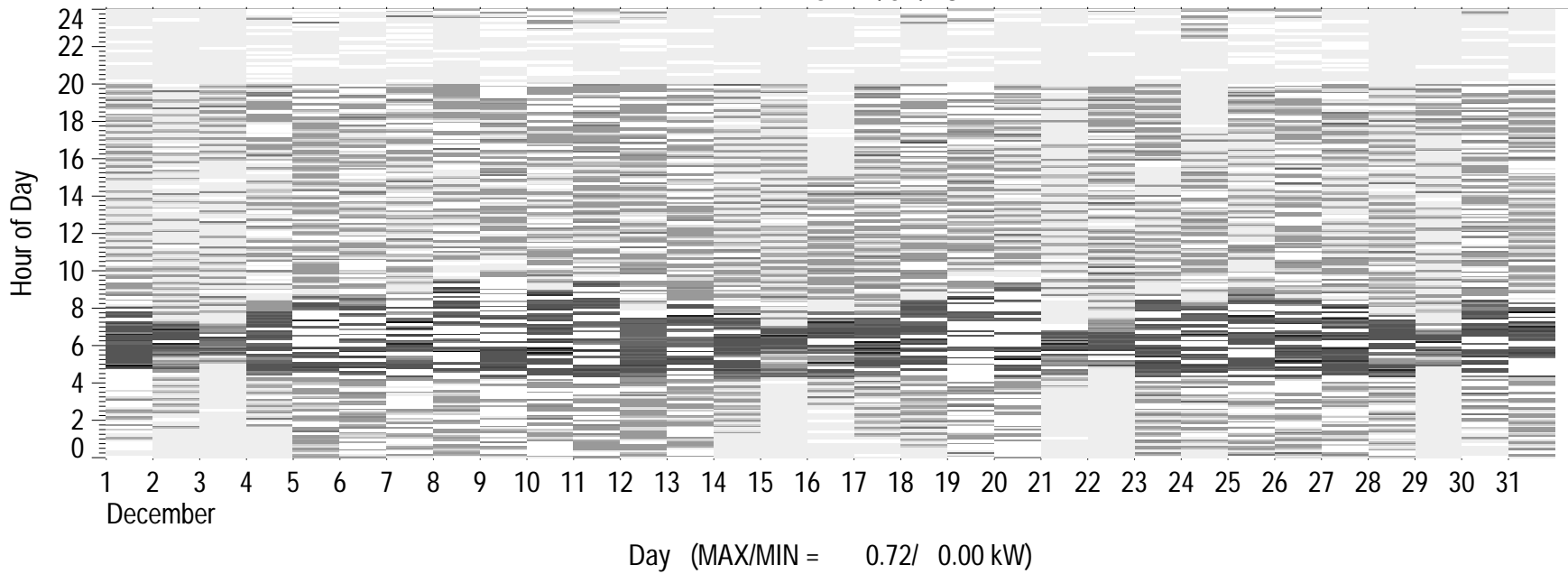
WF: HP5 12/01/18



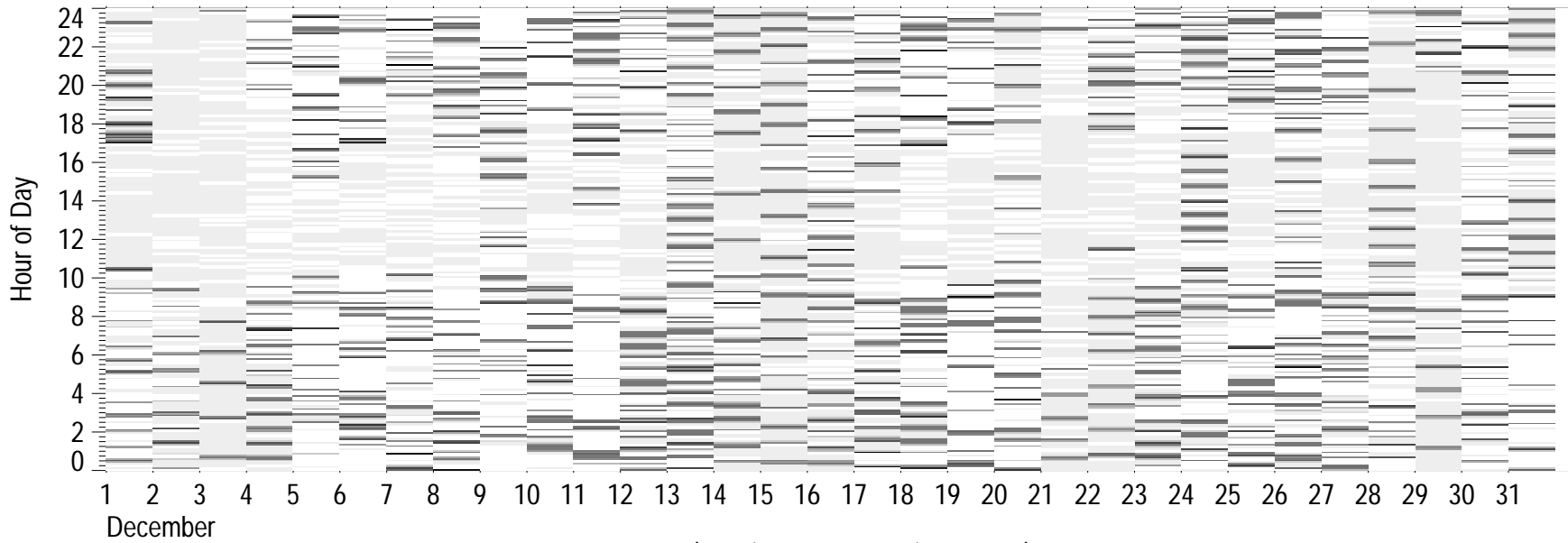
WC: HP6 12/01/18



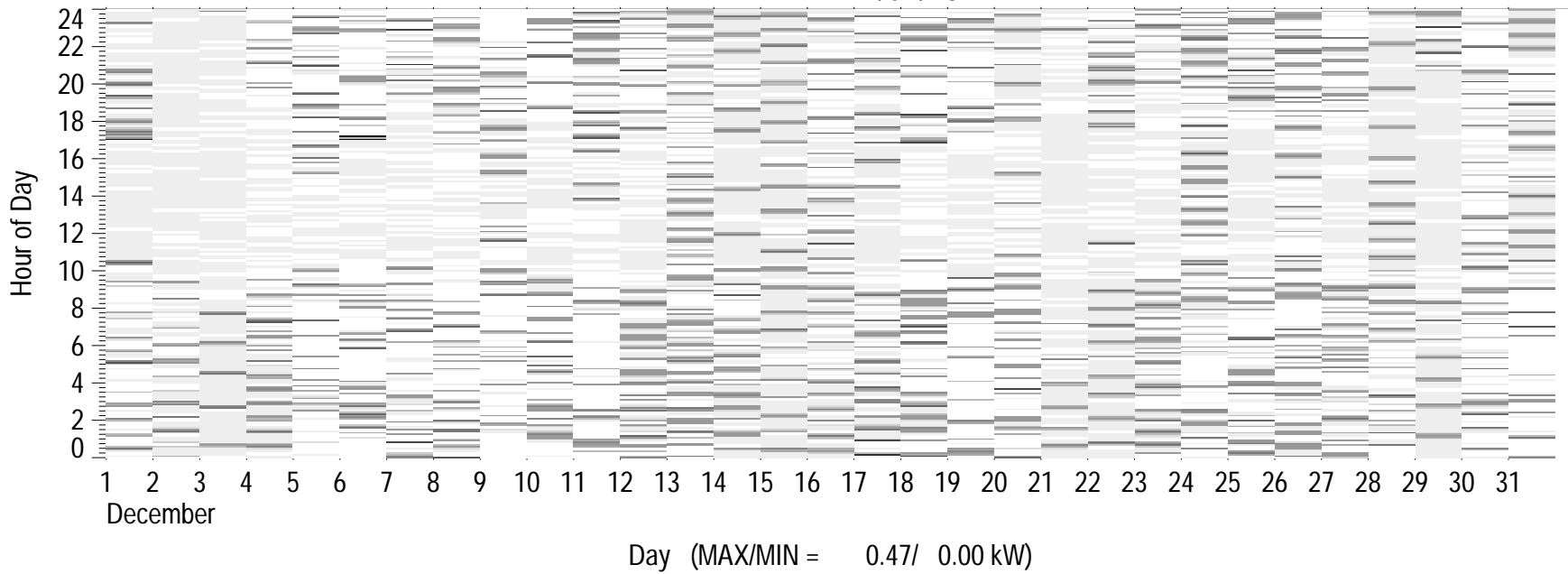
WF: HP6 12/01/18



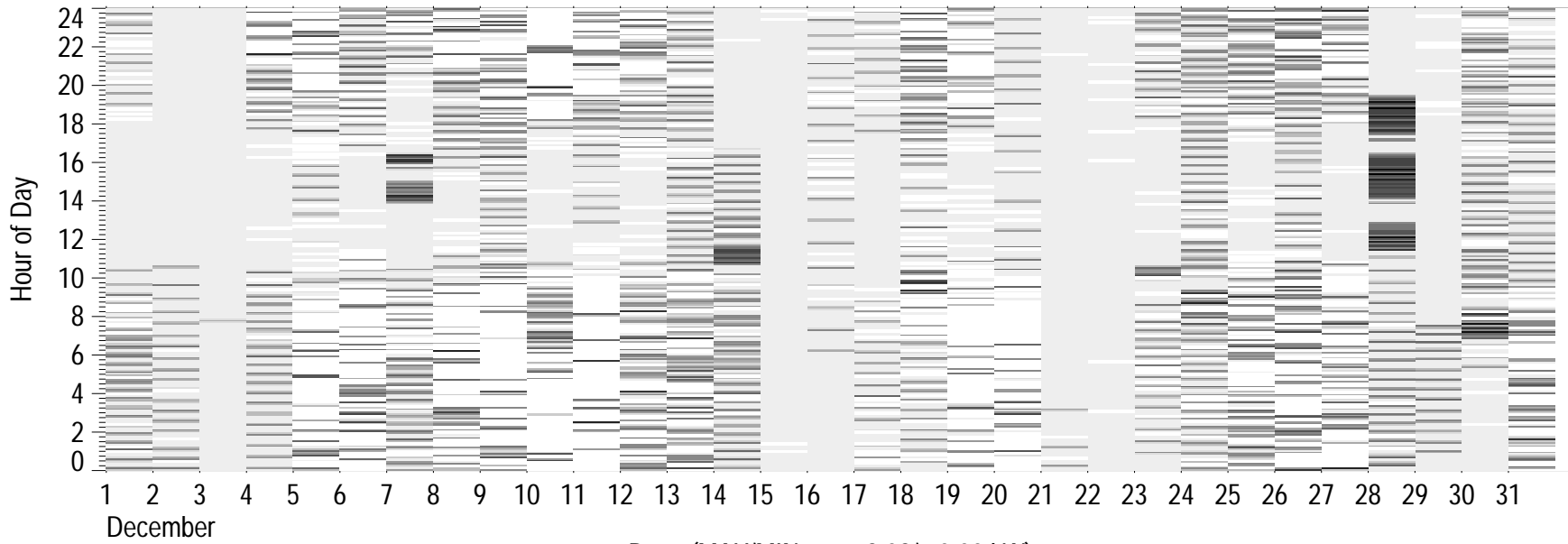
WC: HP7 12/01/18



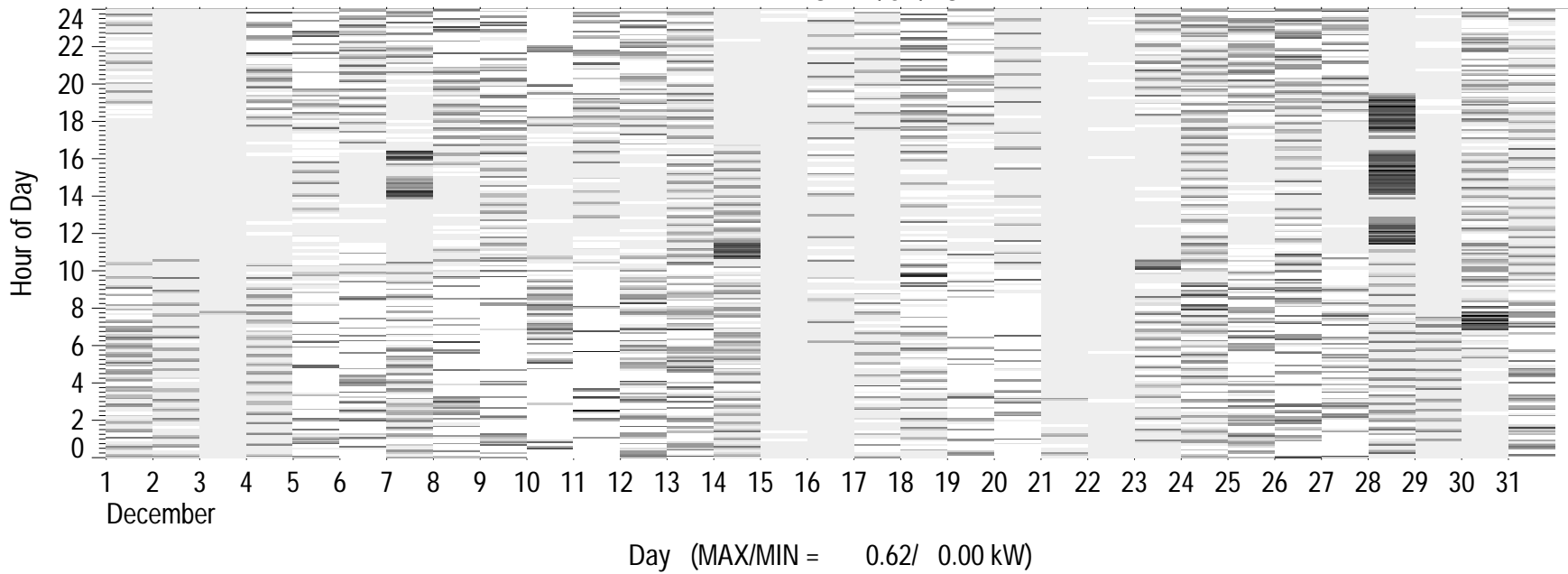
WF: HP7 12/01/18



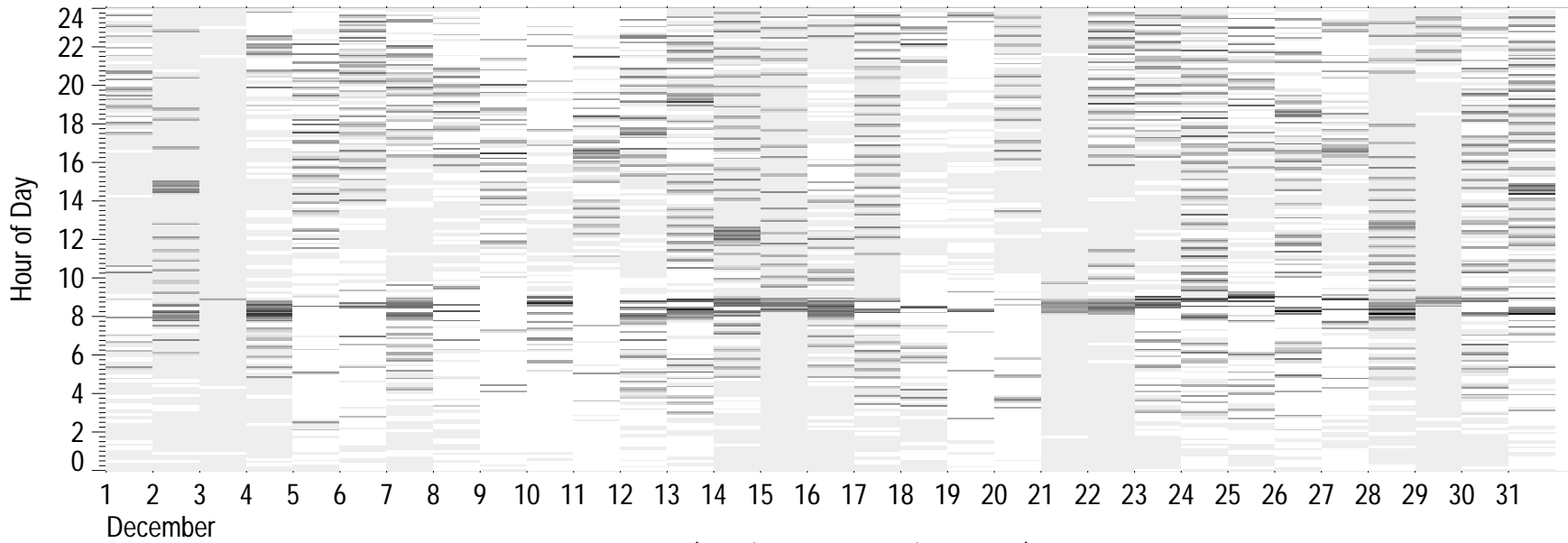
WC: HP8 12/01/18



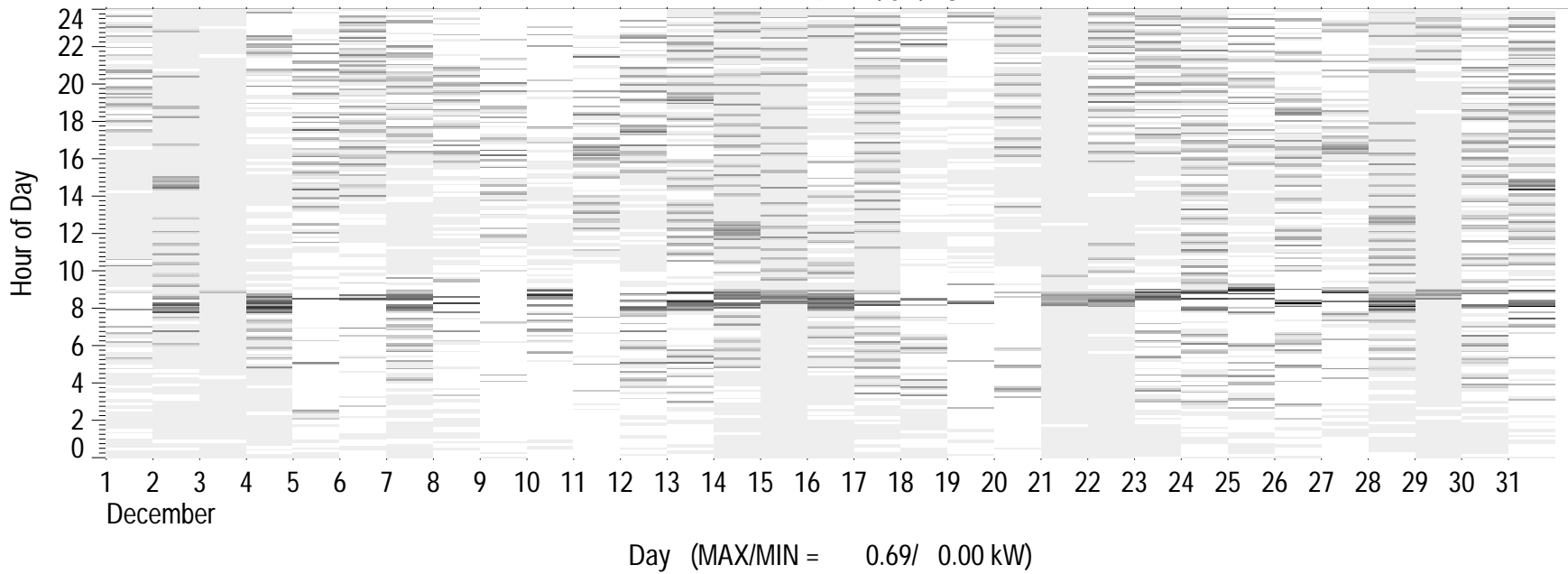
WF: HP8 12/01/18



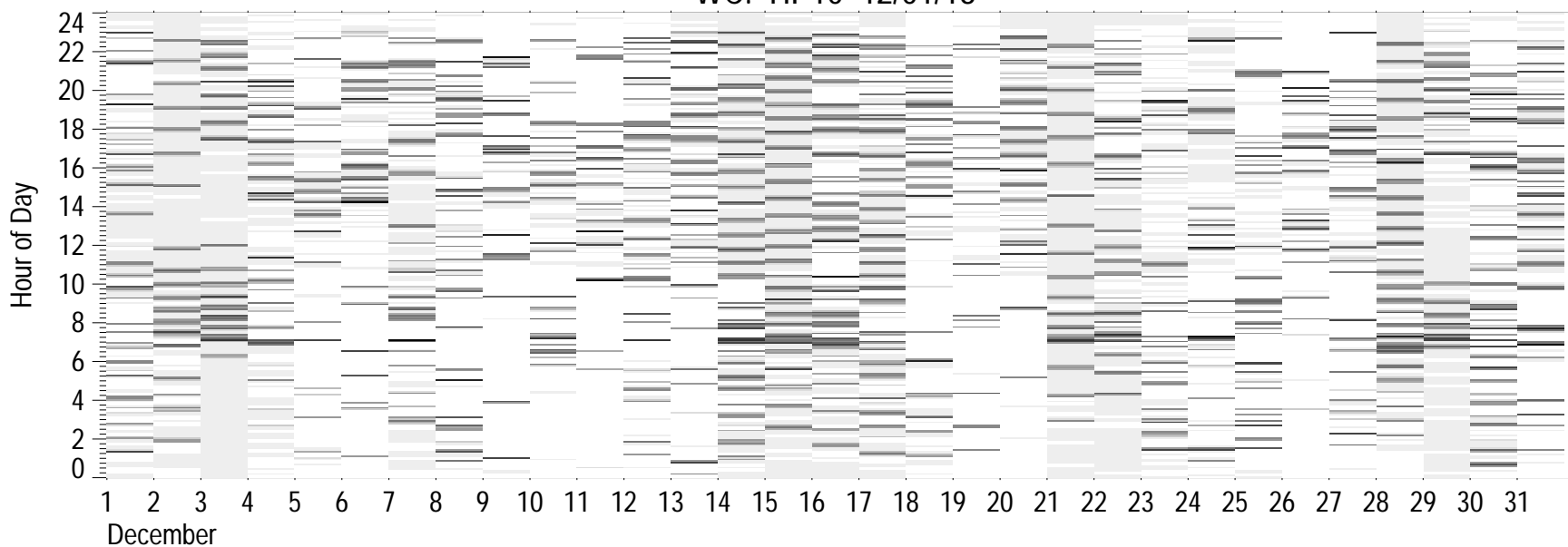
WC: HP9 12/01/18



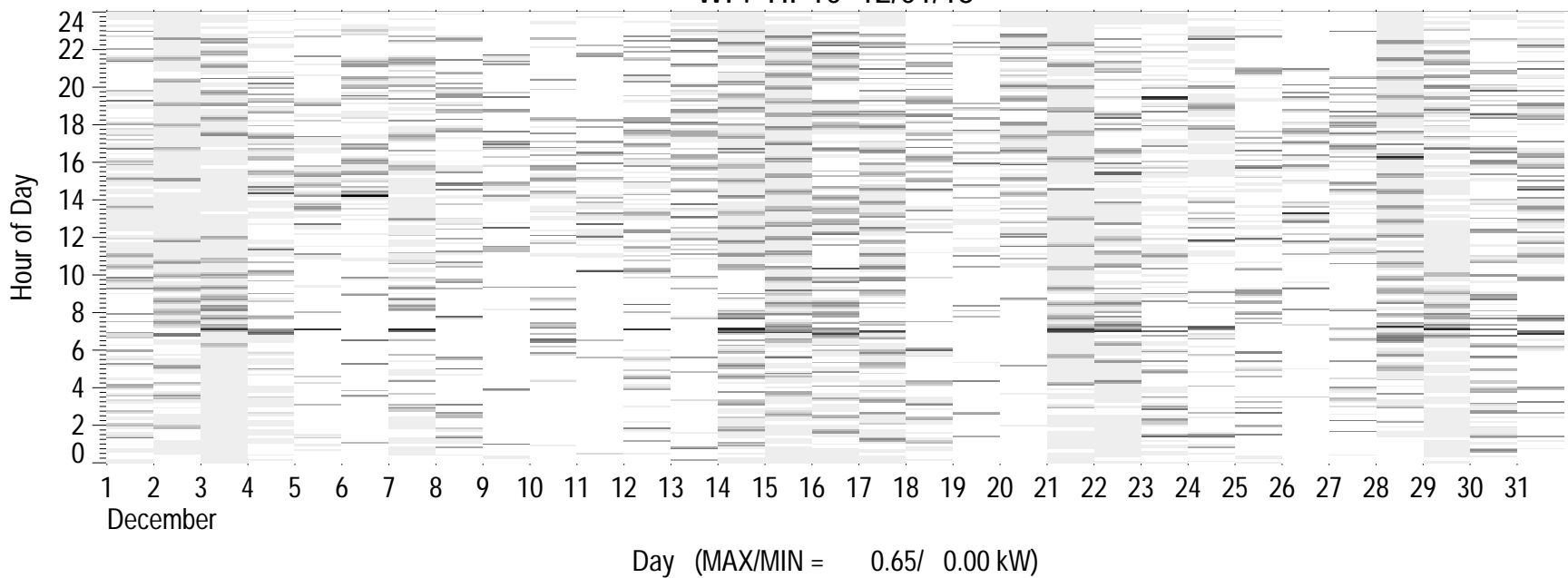
WF: HP9 12/01/18



WC: HP10 12/01/18



WF: HP10 12/01/18



Appendix E  
Geothermal Gas REV Demonstration Project  
Q4 2019 Report



The Project Implementation Plan and previous quarterly reports for the Project are available on the dps.ny.gov website and via the following links:

Public Filings	
Project Implementation Plan	<a href="http://documents.dps.ny.gov/public/Common/ViewDoc.aspx?DocRefId={6B46DC05-BA52-4992-A56B-B1AB28C020D7}">http://documents.dps.ny.gov/public/Common/ViewDoc.aspx?DocRefId={6B46DC05-BA52-4992-A56B-B1AB28C020D7}</a>
Q3 2017	<a href="http://documents.dps.ny.gov/public/Common/ViewDoc.aspx?DocRefId={0290587D-7CB5-4EB5-8B1E-CA29EDAD7978}">http://documents.dps.ny.gov/public/Common/ViewDoc.aspx?DocRefId={0290587D-7CB5-4EB5-8B1E-CA29EDAD7978}</a>
Q4 2017	<a href="http://documents.dps.ny.gov/public/Common/ViewDoc.aspx?DocRefId={6B74BB95-926C-4CA0-B502-B2830E390E91}">http://documents.dps.ny.gov/public/Common/ViewDoc.aspx?DocRefId={6B74BB95-926C-4CA0-B502-B2830E390E91}</a>
Q1 2018	<a href="http://documents.dps.ny.gov/public/Common/ViewDoc.aspx?DocRefId={46430712-C78F-49E6-BBCA-E3FFC39DCD5E}">http://documents.dps.ny.gov/public/Common/ViewDoc.aspx?DocRefId={46430712-C78F-49E6-BBCA-E3FFC39DCD5E}</a>
Q2 2018	<a href="http://documents.dps.ny.gov/public/Common/ViewDoc.aspx?DocRefId={3052D3BE-53C9-4032-8198-A95FC315A782}">http://documents.dps.ny.gov/public/Common/ViewDoc.aspx?DocRefId={3052D3BE-53C9-4032-8198-A95FC315A782}</a>
Q3 2018	<a href="http://documents.dps.ny.gov/public/Common/ViewDoc.aspx?DocRefId={9BDDAA25-C91E-4084-BF9B-3524B59CBC01}">http://documents.dps.ny.gov/public/Common/ViewDoc.aspx?DocRefId={9BDDAA25-C91E-4084-BF9B-3524B59CBC01}</a>
Q4 2018	<a href="http://documents.dps.ny.gov/public/Common/ViewDoc.aspx?DocRefId={7756FBC5-B41F-491C-877B-7A50EB34CCCC}">http://documents.dps.ny.gov/public/Common/ViewDoc.aspx?DocRefId={7756FBC5-B41F-491C-877B-7A50EB34CCCC}</a>
Q1 2019	<a href="http://documents.dps.ny.gov/public/Common/ViewDoc.aspx?DocRefId={D82359B3-55A4-4D00-AE54-C3F8BCC83E01}">http://documents.dps.ny.gov/public/Common/ViewDoc.aspx?DocRefId={D82359B3-55A4-4D00-AE54-C3F8BCC83E01}</a>
Q2 2019	<a href="http://documents.dps.ny.gov/public/Common/ViewDoc.aspx?DocRefId={8E60FD80-B31E-469A-BE8E-9E43B4AE3861}">http://documents.dps.ny.gov/public/Common/ViewDoc.aspx?DocRefId={8E60FD80-B31E-469A-BE8E-9E43B4AE3861}</a>
Q3 2019	<a href="http://documents.dps.ny.gov/public/Common/ViewDoc.aspx?DocRefId={1B702C00-9DE7-4EF2-95F6-B6817A8B087F}">http://documents.dps.ny.gov/public/Common/ViewDoc.aspx?DocRefId={1B702C00-9DE7-4EF2-95F6-B6817A8B087F}</a>

The Q4 2019 Report is provided in its entirety in this Appendix E as follows.



**Geothermal  
Gas REV Demonstration Project  
Long Island, New York**

**Q4 2019 Report**

April 3, 2020

**Table of Contents**

- 1. Executive Summary..... 1**
- 2. Highlights in Q4 2019 ..... 2**
  - 2.1 Major Task Activities ..... 2
  - 2.1.1 Stakeholder Engagement ..... 2
  - 2.1.2 Data Collection ..... 2
- 3. Work Plan & Budget Review ..... 2**
  - 3.1 Project Work Plan..... 3
- 4. Appendix A..... 5**

# 1. Executive Summary

---

KeySpan Gas East Corporation d/b/a National Grid (“National Grid” or the “Company”) is testing a shared geothermal well system to provide a cost-effective heating and cooling solution using ground source heat pumps (“GSHPs”) as an alternative to extending natural gas pipes to a residential community (Glenwood Village Site) and a single geothermal well system for a veterans group home in the Hamlet of Medford, Town of Brookhaven (“Medford Site”). Both Project sites are within the Company’s service territory.<sup>1</sup>

GSHP is a renewable heating and cooling technology that has the potential to decarbonize the heating and cooling sector while providing homeowners with significant energy cost savings and comfort-related benefits. The technology also has the potential to deliver benefits to the gas and electric systems by reducing peak loads.

The Company is committed to supporting the achievement of New York State’s greenhouse gas (“GHG”) emissions reductions goals of 40% reduction of GHG emissions reductions by 2030, and the enhanced GHG emissions reductions goal of 85% by 2050 established in the signed Climate Leadership and Community Protection Act. This Geothermal Gas REV Demonstration Project (“Project”) will provide the Company with a test-and-learn opportunity to validate the benefits of GSHP with the New York State Energy Research and Development Authority (“NYSERDA”), confirm GSHP and district loop performance, and evaluate market strategies to increase technology adoption, including utility ownership of geothermal assets.

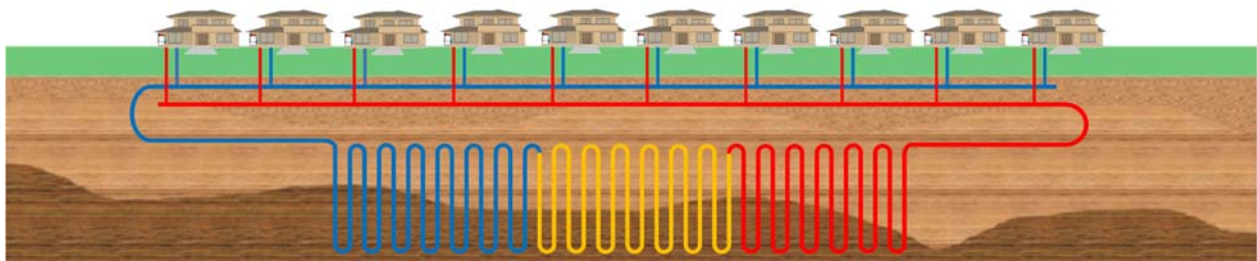


Figure 1. The concept of a shared a GHP system providing service to multiple homes.

In Q4 2019 and January 2020, the Project team worked on project closeout tasks and the heat pump installation at the Medford Site. Data collection at the Glenwood Village Site continued through December 31, 2019. This quarterly report highlights major activities undertaken in Q4 2019 and January 2020 of this Project.<sup>2</sup> This is the final quarterly report for the Project.

---

<sup>1</sup> The Project was approved in the 2016 KEDLI Rate Case. See Cases 16-G-0058 et al., *Proceeding on Motion of the Commission as to the Rates, Charges, Rules and Regulations of KeySpan Gas East Corporation d/b/a National Grid for Gas Service et al.*, Order Adopting Terms of Joint Proposal and Establishing Gas Rate Plans (issued December 16, 2016).

<sup>2</sup> Final Project activities that extended into early Q1 2020 have been incorporated into the Q4 2019 Report for efficiency.

## 2. Highlights in Q4 2019

---

### 2.1 Major Task Activities

The Project team worked on three primary tasks during the reporting period. First, the heat pump was installed at the Medford Site following the completion of building plumbing, electrical and ductwork in January 2020. As a result of construction delays, limited performance data exists as of the writing of this report.

Second, the Project team continued to collect data and monitor the system at Glenwood Village to ensure proper system function during the transition from cooling season to the heating season. System temperatures operated within the design parameters. The heat pumps achieved high coefficients of performance (“COPs”) due to mild average outdoor temperatures.

Finally, the Project team worked on project closeout tasks to prepare the final report. Closeout activities included vendor and partner engagement for final deliverables.

#### 2.1.1 Stakeholder Engagement

- The Project team continued to work with NYSERDA during Q4 2019 on data collection and project closeout tasks. The Project team and NYSERDA also agreed to complete the evaluation, measurement, and verification (“EM&V”) report in March 2020.

#### 2.1.2 Data Collection

- The installed ground heat exchanger at Glenwood Village ranged from 44°F to 67°F and an average outdoor temperature of 45°F from October 2019 to December 2019.
- The performance data of each heat pump at Glenwood Village was calculated. Individual performance values can be found in Appendix A.

## 3. Work Plan & Budget Review

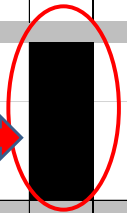
---

Table 3. Budget Information Updated for Q4 2019.

Project Task	4 <sup>rd</sup> Quarter Actual Spend	Project Total Spend to Date	Project Budget	Remaining Balance
<b>CapEx</b>				
	\$0	\$0	\$0	\$0
<b>OpEx</b>				
Implementation	\$11,550	\$430,788	\$450,000	\$19,211
<b>Total</b>	<b>\$11,550</b>	<b>\$430,788</b>	<b>\$450,000</b>	<b>\$19,211</b>



Geothermal Heat Pump Pilot Program - Implementati		CY 2017						CY' 2019												CY' 2020				
		Jul-17	Aug-17	Sep-17	Oct-17	Nov-17	Dec-17	Jan-19	Feb-19	Mar-19	Apr-19	May-19	Jun-19	Jul-19	Aug-19	Sep-19	Oct-19	Nov-19	Dec-19	Jan-20	Feb-20	Mar-20	Apr-20	
6.00	Geothermal Pilot Installation (Jul17-Jun18)																							
6.10	Testing, Permitting, Construction, & Installation of Geothermal Ground Loop System																							
6.20	Customer HVAC Equipment Installation																							
6.30	System Testing/Commissioning/Post Inspection																							
7.00	Engineering Technical Assistance (Nov17-Aug19)																							
7.10	Energy Use Data collection & analysis																							
7.20	Conduct Ongoing Technical Study on Geothermal Pilot Project Objectives including: validate installation costs & customer energy savings, cost/benefit analysis on gas & electric peak demand-cost avoidance, Environmental and Economic Benefit Analysis, Life Cycle Cost Savings, etc.																							
7.30	Periodic Regulatory Updates/Status Reporting on Geothermal Pilot Project Performance																							
8.00	Final Summary Report to Regulators (Dec19)																							
8.10	Compile Results & Issue Final Report																							
8.20	Review of Policy Options/Recommendations, Future Business Models/Ownership, Market Potential Assessment/Scalability, Economic/Societal/Customer value-added benefits, cost-effectiveness and affordability																							



## 4. Appendix A.

### GSHP Performance Analysis

Table 5. The Monthly Average Heating COP from January 2018 to December 2018 at Glenwood Village.<sup>3,4</sup>

Month	2017 Heating Degree Days (HDD, Base 65)	2018 Heating Degree Days (HDD, Base 65)	Unit 1	Unit 2	Unit 3	Unit 4	Unit 5	Unit 6	Unit 7	Unit 8	Unit 9	Unit 10	Avg. COP
Jan	965	1167	2.1	3.2	3.3	NA	2.6	2.5	3.5	2.8	3.3	4.5	3.1
Feb	836	778	2.2	2.9	3.1	NA	2.4	2.3	3.3	2.7	2.7	3.1	2.7
Mar	929	851	2.2	2.8	3.4	NA	2.5	2.2	3.4	2.8	2.8	3.1	2.8
Apr	460	662	2.2	3	3.6	NA	2.5	2.4	3.5	2.8	2.9	3.2	2.9
May	301	190	3.3	5.6	5.3	2.6	3.1	4	4.4	4.9	4.5	4.1	4.2
Jun	84	89	4.2	5.7	5.8	6.6	5.5	5.4	6.1	5	5.7	6.6	5.7
Jul	5	10	-	-	-	-	-	-	-	-	-	-	-
Aug	13	3	-	-	-	-	-	-	-	-	-	-	-
Sep	72	39	-	-	-	-	-	-	-	-	-	-	-
Oct	614	365	2.4	3.7	4.6	5	3.1	2.4	4.4	3.8	5.4	5	4.0
Nov	1091	692	2.3	3	4.2	3.5	2.6	2.4	3.8	3.4	4.9	5.5	3.6
Dec	901	901	2.2	2.9	4.4	3.6	3	2.4	3.8	4.8	3.7	5.3	3.6
Avg.	Total 6271	Total 5747	2.6	3.6	4.2	4.3	3.0	2.9	4.0	3.7	4.0	4.5	3.6

<sup>3</sup> Note: 5, 6, 9, 10 had data gaps during January 2018.

<sup>4</sup> Past weather data were retrieved from Long Island McCarthur Airport available on [www.wunderground.com](http://www.wunderground.com).



Table 6. The Monthly Average Heating COP from January 2019 to December 2019 at Glenwood Village.<sup>5</sup>

Month	2018 Heating Degree Days (HDD, Base 65)	2019 Heating Degree Days (HDD, Base 65)	Unit 1	Unit 2	Unit 3	Unit 4	Unit 5	Unit 6	Unit 7	Unit 8	Unit 9	Unit 10	Avg. COP
Jan	1167	1044	2.2	2.9	3.6	3.3	2.6	2.9	3.5	3.0	2.8	3.1	3.0
Feb	778	982	2.2	2.9	3.5	3.3	2.6	2.8	3.4	3.2	2.8	3.0	3.0
Mar	851	808	2.1	2.9	3.5	3.2	2.4	2.9	3.4	3.1	2.8	3.0	2.9
Apr	662	450	2.2	3.1	3.6	4.3	2.6	2.6	4.1	3.9	3.0	3.4	3.3
May	190	205	2.8	5.7	5.3	6.0	2.9	2.9	3.7	-	2.9	6.1	4.3
Jun	89	77	-	-	-	-	-	-	-	-	-	-	-
Jul	10	0	-	-	-	-	-	-	-	-	-	-	-
Aug	3	1	-	-	-	-	-	-	-	-	-	-	-
Sep	39	28	-	-	-	-	-	-	-	-	-	-	-
Oct	365	231	2.6	-	5.2	5.6	3.0	4.6	4.5	4.8	4.5	5.4	4.5
Nov	692	682	2.6	-	3.9	3.8	2.7	2.5	3.7	3.0	3.9	5.3	3.5
Dec	901	863	3.0	-	3.7	3.6	2.7	2.5	3.6	4.1	3.4	4.9	3.5
Avg	Total	Total	2.5	3.5	4.0	4.1	2.7	3.0	3.7	3.6	3.3	4.3	3.5
	5747	5371											

Note: Data was not available for Unit 2 in Q4 2019 due to issues with data quality.

<sup>5</sup> Past weather data were retrieved from Long Island McCarthur Airport available on [www.wunderground.com](http://www.wunderground.com).

Table 7. The Monthly Average Cooling Energy Efficiency Ratio (“EER”) from May 2018 to December 2018 at Glenwood Village

Month	2017 Cooling Degree Days (HDD, Base 65)	2018 Cooling Degree Days (HDD, Base 65)	Unit 1	Unit 2	Unit 3	Unit 4	Unit 5	Unit 6	Unit 7	Unit 8	Unit 9	Unit 10	Avg. EER
May	16	9	5.7	12.6	11.3	3.5	4	7.6	8.7	10.3	8.8	7.1	8
Jun	96	86	8.3	12.6	12.9	16.3	12.4	11.8	14.5	10.3	12.7	15.4	12.7
July	203	543	10.3	12.5	13.5	18.4	12.4	11.9	15	11.2	12.5	15.4	13.3
Aug	133	285	10.1	12.4	13.4	18.2	13.2	12	14.6	8.1	12.2	15.2	12.9
Sept	93	118	7.9	12.4	14	17.6	12.5	11.1	14.8	10	12.5	15.7	12.9
Oct	1	26	2.4	6.6	9.5	-	4.8	-	-	-	-	-	5.8
Nov	0	0	-	-	-	-	-	-	-	-	-	-	-
Dec	0	0	-	-	-	-	-	-	-	-	-	-	-
Avg.	Total 542	Total 1067	7.5	11.5	12.4	14.8	9.9	10.9	13.5	10.0	11.7	13.8	10.9

Table 8. The Monthly Average Cooling EER from May 2019 to December 2019 at Glenwood Village

Month	2018 Cooling Degree Days (HDD, Base 65)	2019 Cooling Degree Days (HDD, Base 65)	Unit 1	Unit 2	Unit 3	Unit 4	Unit 5	Unit 6	Unit 7	Unit 8	Unit 9	Unit 10	Avg. EER
May	9	22	3.4	13.5	12.0	0.0	4.2	4.3	0.0	0.0	0.0	14.6	5.2
Jun	86	138	9.1	14.9	15.8	0.0	13.3	13.4	15.6	0.0	13.2	16.8	11.2
Jul	543	394	15.9	13.9	15.9	18.0	13.2	12.2	15.9	11.2	12.9	15.5	14.5
Aug	285	254	15.9	12.6	15.9	17.9	13.3	11.7	15.2	11.0	13.1	15.4	14.2
Sep	118	92	16.4	-	16.4	-	13.7	12.8	15.9	13.9	12.6	16.0	14.7
Oct	26	19	3.6	-	11.5	14.3	-	9.2	8.6	9.6	8.7	11.3	9.6
Nov	0	0	-	-	-	-	-	-	-	-	-	-	-
Dec	0	0	-	-	-	-	-	-	-	-	-	-	-
Avg.	Total	Total	10.7	13.7	14.6	10.0	11.5	10.6	11.9	7.6	10.1	14.9	12.0
	1067	919											

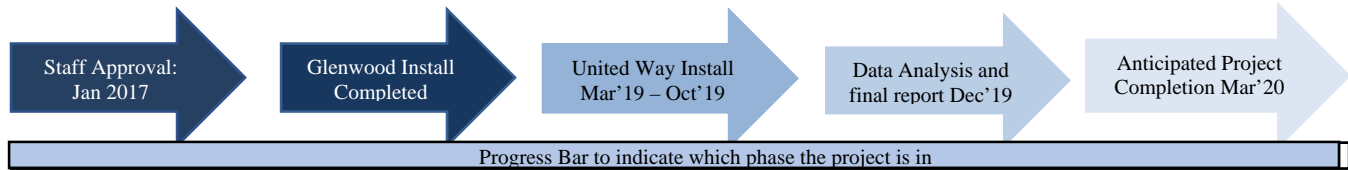
**Project Start Date:** 01/01/2017

**Project End Date:** 03/31/2020

**Budget:** \$450,000

**Current Quarter Spend:** \$11,550

**Cumulative Spend:** \$430,788



**Project Summary:** This Project is a test-and-learn demonstration being undertaken by the KeySpan Gas East Corporation d/b/a National Grid (“National Grid” or the “Company”) involving design and installation of both a shared geothermal loop system and a single loop system owned by National Grid to provide cost-effective heating and cooling using ground source heat pumps (“GSHP”) as an alternative to extending natural gas to Long Island communities in the National Grid service territory. The Project partners are NYSERDA, PSEG-LI, Miller Environmental, and GEO-NII.

Cumulative Lessons Learned		
The Customer	Market Partners	Utility Operations
<ul style="list-style-type: none"> <li>Project participants widely exhibit a high satisfaction touting the plethora of added comfort-related benefits compared to their conventional systems.</li> <li>Annual cost savings for participants at Glenwood Village ranged from \$341 to \$1,037 or 31% to 60%.</li> <li>Minimal to no auxiliary electric heat was required for most homes during the 2019 heating season.</li> </ul>	<ul style="list-style-type: none"> <li>GSHP represents less than 1% of the HVAC market; lack of volume increases overall cost in the current market.</li> <li>There are a small number of qualified industry professionals; workforce development is vital to address as part of a market scale-up.</li> <li>The industry is highly reliant on utility and government incentives. The market experienced a sharp reduction of GSHP installations when the federal ITC expired in 2016.</li> <li>Utility backing and marketing can improve technology confidence and accelerate market adoption.</li> </ul>	<ul style="list-style-type: none"> <li>Utility ownership of GSHP can reduce the upfront cost barrier and offer lower systems cost with scale. NYSERDA estimates an additional cost reduction of a minimum of 10% with utility ownership, through economies of scale.</li> <li>Utility involvement can ensure that systems are correctly installed to promote durability and maximize system performance.</li> <li>GSHP can provide an abundance of both electric and gas grid benefits if adequately designed and installed.</li> </ul>

**Application of Lessons Learned:** Through this test-and-learn demonstration, the Company gathered experience around the technology benefits, market potential, and customer preference for a renewable heating and cooling system. The Company plans to use the takeaways from the Project to propose a geothermal program in the Downstate New York service territory. This ambition is consistent with the Company’s *Northeast 80x50 Pathway*, the REV objectives, and supporting the State’s clean energy agenda.

**Issues Identified:** None

**Solutions Identified:** None

**Recent Milestones/Targets Met:** The Project team completed all construction-related activities at the Medford Site. Data collection and performance validation for the Glenwood Village Site was completed.

**Upcoming Milestones/Targets:** Draft and submit the final report.

<sup>6</sup> Final Project activities that extended into early Q1 2020 have been incorporated into the Q4 2019 Report for efficiency as this is the final quarterly report for the Project.

Appendix F  
Installation Photos



The community park at the beginning of construction, midway after pressure testing, and final landscape restoration at the Glenwood Village Site.



Photo of the well cuttings being shoveled out of the portable mud pit at the Glenwood Village Site.





Photo of the geothermal pipes being installed after well boring completion at the Glenwood Village Site.



Photo of the pipe headers and valves in the community part at the Glenwood Village Site.



The outdoor split system at the Glenwood Village Site.



The indoor split system with front panels removed at the Glenwood Village Site.





Photo of the Project GSHP setup at the Medford Site with equipment from left to right consisting of the WaterFurnace® 7 Series, flow center, domestic hot water tank, and landlord-provided hybrid electric water heater.