



LIBERTY WIND

PROPOSAL IN RESPONSE TO THE REQUEST FOR PROPOSALS TO PROCURE OFFSHORE WIND RENEWABLE ENERGY CERTIFICATES ISSUED BY THE NEW YORK STATE RESEARCH AND DEVELOPMENT AUTHORITY ON NOVEMBER 8, 2018

PROJECT THREE - 1200 MW

Prepared by Vineyard Wind LLC, 412 West 15th Street, 15th Floor, New York, NY 10014
Lars Thaaning Pedersen / 508-717-8964 / [REDACTED]
Submitted on February 14, 2019



As contemplated under Sections 6.2.2 and 8.1 of the Request for Proposals ORECRFP 18-1 issued November 8, 2018 and as further described in the Attachment 1 – Statement and Request for Confidential Treatment (the “Cover Letter”) included with Vineyard Wind’s cover letter dated February 14, 2019, certain information in this document or electronic file and the appendices listed below, each of which forms a part of this proposal, is non-public, confidential and proprietary information including commercial and financial information and trade secrets (as further defined in the Cover Letter, “Confidential Information”). Vineyard Wind intends for all such Confidential Information to remain confidential and be treated as such by NYSERDA and the Scoring Committee. Under the New York Public Officers Law, Article 6, the New York State Freedom of Information Law (the “FOIL”) and NYSERDA’s implementing regulations under 21 NYCRR Part 501, the Confidential Information contained in this proposal is not a public record and is exempt from public records requests. Confidential Information is highlighted in light grey and/or is clearly marked “CONFIDENTIAL”.

Table of Contents

SECTION 1 EXECUTIVE SUMMARY OF THE PROPOSAL	1-1
Liberty Wind.....	1-1
Liberty Wind Project Overview	1-3
Robust and Well-Developed Grid Connection to New York.....	1-4
[REDACTED]	1-6
[REDACTED]	1-6
[REDACTED]	1-9
Unmatched Local Know How.....	1-11
Global Experience and World Class Expertise.....	1-12
Financially Strong Backers Ready to Invest in Liberty Wind.....	1-14
Liberty Wind Meets or Exceeds all the RFP Requirements	1-15
 SECTION 2 PROPOSER EXPERIENCE	 2-1
Copenhagen Infrastructure Partners	2-5
Avangrid Renewables	2-5
Avangrid Networks.....	2-7
Scottishpower Renewables	2-7
Anbaric.....	2-8
Key Partners & Consultants.....	2-8
Executive Committee	2-12
Vineyard Wind Key Personnel	2-15
Vineyard Wind Execution Personnel.....	2-15
Vineyard Wind LLC Development Personnel.....	2-19
Anbaric Development Partners Team.....	2-20
References	2-23
Lead Market Participant	2-26

Table of Contents (Continued)

SECTION 3 PROJECT DESCRIPTION AND SITE CONTROL	3-1
Overview	3-1
Offshore Wind Generation Facility Site	3-2
Offshore Export Cable Route.....	3-3
Onshore Facilities	3-6
Landfall Site.....	3-7
Onshore Export Cable Route.....	3-8
Onshore Substation.....	3-9
Site Control.....	3-11
SECTION 4 ENERGY RESOURCE ASSESSMENT AND PLAN	4-1
Overview	4-1
Additional Wind Data Collection Efforts.....	4-6
Net Annual Energy Production	4-7
Methodology	4-10
Wind Resource Assessment	4-11
SECTION 5 OPERATIONAL PARAMETERS	5-1
Maintenance Outage Requirements.....	5-1
Operational Limits.....	5-3
Scheduled Maintenance	5-3
Unscheduled Maintenance.....	5-4
[REDACTED]	5-4
SECTION 6 BUSINESS ENTITY AND FINANCING PLAN	6-1
Financial Viability of the Proposers.....	6-1
Business Entity Structure.....	6-2
Shareholders, Subsidiaries, and Partners Supporting the Project.....	6-7
Financing Plan for the Project	6-10
Financing Experience.....	6-13
Financial Strength of the Proposers.....	6-15
Role of Tax Incentives.....	6-17
Financial Reports of Proposers.....	6-17
Vineyard Wind Officers and Board Members	6-18
Anbaric Development Partners Officers and Board Members.....	6-18
Ability to Provide Security.....	6-19
SECTION 7 INTERCONNECTION AND DELIVERABILITY	7-1
Overview	7-1
Nyiso Interconnection Requests	7-2
[REDACTED]	7-3

Table of Contents (Continued)



	7-4
	7-4
Interconnection Studies.....	7-5
SECTION 8 ENVIRONMENTAL ASSESSMENT AND PERMIT ACQUISITION PLAN	8-1
Overview	8-1
List of Federal Permits or Approvals Required.....	8-3
Federal Permitting Process and Approvals	8-4
State Permitting Process and Approvals.....	8-6
Article VII.....	8-6
Other Easements and Rights	8-8
County and Local Permitting Process and Approval.....	8-9
A World Class Permitting Team will Ensure The Success of the Project.....	8-10
Federal Permitting Timeline	8-12
New York/ County / Local Permitting Timelines.....	8-14
SECTION 9 ENGINEERING AND TECHNOLOGY	9-1
Overview	9-1
Preliminary Engineering Plan	9-3
Offshore Wind Turbine Generators	9-4
Foundations	9-6
Inter-Array Cables.....	9-7
Electrical Service Platform.....	9-8
Offshore Export Cable	9-9
Onshore Export Cable	9-10
Onshore Substation.....	9-11
Supply Chain Investigation Phase.....	9-15
Structuring, Tenders, and Supplier Proposals.....	9-16
Wind Turbine Generators	9-19
Foundations	9-20
Inter-Array Cables.....	9-20
Electrical Service Platforms	9-20
Export Cables.....	9-21
Onshore Substation.....	9-21
SECTION 10 OF APPENDIX B TO THE RFP PROJECT SCHEDULE	10-1
Overview	10-1
Key Milestones Achieved.....	10-2
Project Schedule and Critical Path.....	10-2
Critical Activities.....	10-7

Table of Contents (Continued)

SECTION 11 CONSTRUCTION AND LOGISTICS	11-1
Overview - A Robust Construction and Logistics Set-Up using a New York Port	11-1
Major Project Deployment Steps and Necessary Equipment	11-2
Facilities for Construction of the Project	11-8
Approach for Staging and Deployment of Major Project Components	11-13
Foundations	11-13
Electrical Service Platform.....	11-19
Offshore Export Cables.....	11-21
Inter-Array Cables.....	11-25
Wind Turbine Generators	11-27
Onshore Works.....	11-33
Number, Type, And Size Of Vessels And Their Respective Roles.....	11-37
The Coastwise Laws	11-41
Responsible Party for each Deployment Activity and the Role of Each Party.....	11-44
Contractual Agreements with Third-Party Equipment/Service Providers.....	11-47
 SECTION 12 FISHERIES MITIGATION PLAN	 12-1
Careful Siting and Collaborative Development	12-1
 SECTION 13 ENVIRONMENTAL MITIGATION PLAN	 13-1
Careful Siting and Collaborative Development	13-1
 SECTION 14 COMMUNITY OUTREACH PLAN	 14-1
Community Outreach Plan.....	14-1
Vineyard Wind’s Engagement Activities.....	14-2
████████████████████.....	14-2
Support for Vineyard Wind in the Community	14-3
Support for Anbaric in the Community	14-5
Project Concerns	14-6
 SECTION 15 VISIBILITY AND VIEWSHED IMPACTS	 15-1
Introduction.....	15-5
Project Description	15-5
Methodology	15-6
Meteorological Analysis.....	15-10
Visual Assessment Results.....	15-11
Potential Visual Impacts of the Project.....	15-12
Conclusion	15-14

Table of Contents (Continued)

SECTION 16 ECONOMIC BENEFITS PLAN	16-1
Liberty Wind - Economic Development for New York.....	16-1
Distributing Liberty Wind Expenditures Across the State of New York.....	16-3
Directly Funded Initiatives to Accelerate New York Offshore Wind Leadership	16-8
Business Engagement Plan.....	16-12
Workforce Engagement Plan	16-13
Economic Benefits Verification Plan.....	16-14
Overview of the Initiatives Listed in the Offer Data Form.....	16-16








List of Figures

[REDACTED].....	1-3
[REDACTED].....	1-7
[REDACTED].....	1-8
[REDACTED].....	1-10
Figure 1.1-6 Our Offshore (Blue) and Onshore Wind (Green) Experience.....	1-13
[REDACTED].....	2-2
[REDACTED].....	2-2
[REDACTED].....	2-4
Figure 2.2-2 Map of Avangrid Renewables Assets in the US (December 2017).....	2-7
[REDACTED].....	2-12
[REDACTED].....	2-20
[REDACTED].....	3-3
[REDACTED].....	3-5
[REDACTED].....	3-5
[REDACTED].....	3-6
[REDACTED].....	3-14
[REDACTED].....	3-15
[REDACTED].....	3-16
[REDACTED].....	3-17
[REDACTED].....	3-18
[REDACTED].....	4-3
[REDACTED].....	4-4
[REDACTED].....	4-12











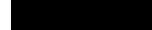
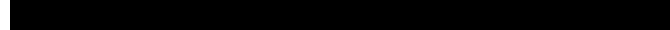
List of Figures (Continued)

[REDACTED]	5-5
[REDACTED]	6-3
[REDACTED]	6-4
[REDACTED]	6-6
[REDACTED]	6-7
Figure 6.2-5 Avangrid’s Corporate Structure (including Vineyard Wind)	6-8
[REDACTED]	6-9
[REDACTED]	7-3
[REDACTED]	7-5
[REDACTED]	7-6
[REDACTED]	7-7
[REDACTED]	7-9
[REDACTED]	7-9
Figure 9.1-1 Offshore Wind Generation and Transmission System	9-4
[REDACTED]	9-5
[REDACTED]	9-6
[REDACTED]	9-7
[REDACTED]	9-8
[REDACTED]	9-10
[REDACTED]	9-11
[REDACTED]	9-12
[REDACTED]	9-15
[REDACTED]	9-17
[REDACTED]	9-18
[REDACTED]	10-4
[REDACTED]	10-9
[REDACTED]	11-3
[REDACTED]	11-9
[REDACTED]	11-11
[REDACTED]	11-12
[REDACTED]	11-14
Figure 11.3-2 [REDACTED]	11-15
Figure 11.3-3 [REDACTED]	11-15
Figure 11.3-4 [REDACTED]	11-15
Figure 11.3-5 [REDACTED]	11-15
Figure 11.3-6 [REDACTED]	11-16
Figure 11.3-7 [REDACTED]	11-16
Figure 11.3-8 Heavy Lift Installation Vessel	11-18

List of Figures (Continued)

	11-20
Figure 11.3-10 Indicative Picture of a Plow Burying a Cable.....		11-23
Figure 11.3-11 Vessel Lowering an Offshore Cable Joint Using a Bow		11-24
Figure 11.3-12 Inter-array Cable Installation Vessel		11-26
Figure 11.3-13 Inter-array Cable Being Pulled into a Foundation.....		11-26
Figure 11.3-14 Heavy Transport Vessels carrying WTG components		11-28
	11-30
	11-30
Figure 11.3-17 Turbine Installation Vessel		11-31
Figure 11.3-18 Installation of Tower Sections, Nacelle, and Blade		11-33
	11-34
Figure 11.3-20 Onshore Open Trench and Duct Bank.....		11-36
Figure 11.3-21 Neptune Project Installation Along Wantagh Parkway, Long Island.....		11-37
Figure 15.1-1 Geometric Horizon Diagram.....		15-1
Figure 15.1-2 Liberty Wind WTG Visibility from Montauk.....		15-2
	15-3
	15-6
	15-7
Figure 15.2-3 Frequency of Common Weather Conditions at Nantucket Airport.....		15-10
Figure 15.2-4 Liberty Wind WTG Visibility from Miacomet Beach		15-11
Figure 15.2-5 Liberty Wind WTG Visibility from Wasque Point.....		15-12
Figure 16.1-1 Liberty Wind’s Project Expenditures in the State of New York.....		16-3
Figure 16.1-2 Transition Piece and ESP Fabrication at the Port of Coeymans		16-4
Figure 16.1-3 Liberty Wind Onshore Transmission System.....		16-6
Figure 16.1-4 Liberty Wind Directly Funded Initiatives		16-8

List of Tables

		1-2
		2-9
		2-10
		2-23
		2-24
		3-12

List of Tables (Continued)

[REDACTED]	[REDACTED]	4-5
[REDACTED]	[REDACTED]	4-7
[REDACTED]	[REDACTED]	4-8
[REDACTED]	[REDACTED]	5-1
[REDACTED]	[REDACTED]	6-14
[REDACTED]	[REDACTED]	6-15
[REDACTED]	[REDACTED]	6-15
Table 6.7-1	Credit Ratings for Avangrid Inc. (January 2019)	6-17
[REDACTED]	[REDACTED]	6-18
[REDACTED]	[REDACTED]	7-4
[REDACTED]	[REDACTED]	7-8
[REDACTED]	[REDACTED]	7-8
[REDACTED]	[REDACTED]	7-8
[REDACTED]	[REDACTED]	7-8
Table 8.1-1	Expected Federal Permits for Liberty Wind ¹	8-5
Table 8.1-2	Expected New York State Permits for Liberty Wind	8-9
Table 8.1-3	Expected Regional and Local Permits for Liberty Wind - CONFIDENTIAL	8-10
[REDACTED]	[REDACTED]	8-12
[REDACTED]	[REDACTED]	9-13
[REDACTED]	[REDACTED]	9-23
[REDACTED]	[REDACTED]	9-24
[REDACTED]	[REDACTED]	9-24
[REDACTED]	[REDACTED]	10-5
[REDACTED]	[REDACTED]	10-10
[REDACTED]	[REDACTED]	11-4
[REDACTED]	[REDACTED]	11-5
[REDACTED]	[REDACTED]	11-8
[REDACTED]	[REDACTED]	11-14
[REDACTED]	[REDACTED]	11-16
[REDACTED]	[REDACTED]	11-17
[REDACTED]	[REDACTED]	11-19
[REDACTED]	[REDACTED]	11-20
[REDACTED]	[REDACTED]	11-21
[REDACTED]	[REDACTED]	11-28
[REDACTED]	[REDACTED]	11-29

List of Tables (Continued)

[REDACTED]	11-31
[REDACTED]	11-38
[REDACTED]	11-39
[REDACTED]	11-39
[REDACTED]	11-40
[REDACTED]	11-41
[REDACTED]	11-42
[REDACTED]	11-44
[REDACTED]	15-4
Table 15.2-1 Frequency of Visibility Ranges on Nantucket Island	15-10
[REDACTED]	16-16
Table 16.1-2 Category 3 - Form IDs -CONFIDENTIAL	16-17



LIBERTY WIND

SECTION 1 - EXECUTIVE SUMMARY OF THE PROPOSAL

Proposal for New York State Energy Research and Development Authority in response to Request For Proposals for Purchase of Offshore Wind Renewable Energy Certificates



Photo: Veja Mate offshore wind farm

SECTION 1
EXECUTIVE SUMMARY OF THE PROPOSAL

Proposers are required to provide an executive summary of the Proposal that documents the eligibility of the proposed Offshore Wind Generation Facility, the proposed Contract Tenor, the overall Project schedule including expected Commercial Operation Date, any contingencies specific to the Proposal or to other Proposals, and other factors Proposers deem to be important.

LIBERTY WIND

Vineyard Wind is proud to submit three proposals in response to Request for Proposals for the Purchase of Offshore Wind Renewable Energy Certificates (ORECRFP18-1). Each proposal offers an attractive price for offshore wind, provides substantial economic development benefits to New York residents and businesses, and minimizes potential impacts on New York’s coastal and other affected interests and communities.

The three proposals are different size variations of **Liberty Wind** (the “Project”), which Vineyard Wind has designed and developed specifically for New York. The proposals include the Required Base Proposal of 400 MW (Project One) and two Alternate Proposals of 800 MW (Project Two) and 1,200 MW (Project Three). A Required Transmission Proposal is included as part of the Required Base Proposal and both Alternate Proposals; in all proposals, Liberty Wind will directly interconnect to a point in NYISO Zone K. Liberty Wind proposals – in particular the 1,200 MW proposal – provide a significant opportunity to make substantial progress in achieving Governor Cuomo’s bold and nation-leading goal of deploying 9,000 MW of offshore wind by 2035.

Liberty Wind offers the best price for New York ratepayers along with substantial economic benefits for New York through investments in local infrastructure and businesses and utilizing the state’s existing supply chain and workforce. Liberty Wind’s Offshore Wind Generation Facility site is located far enough from shore that no wind turbines will be visible from anywhere on the New York coast, yet close enough to be serviced by construction vessels working out of New York ports.

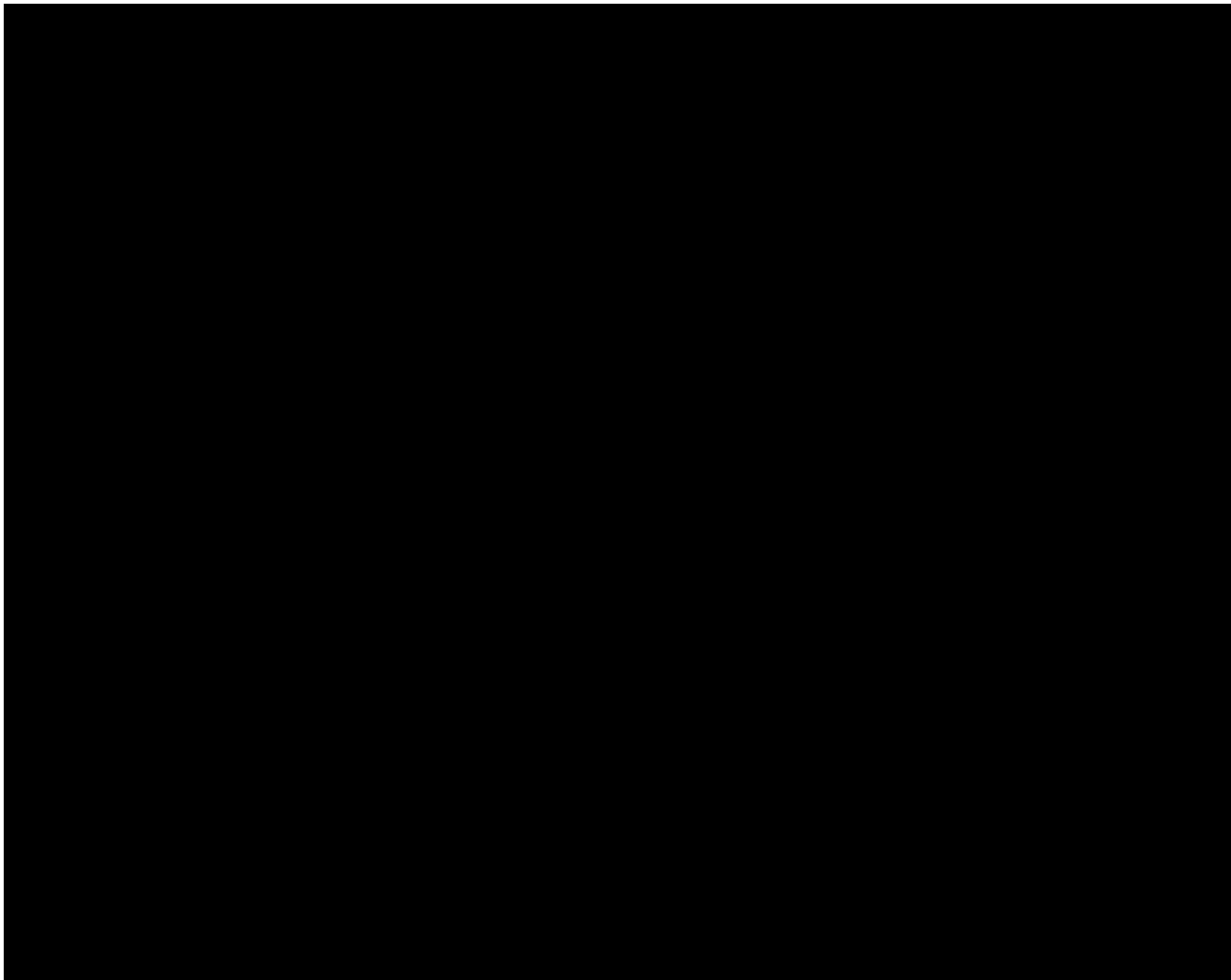
Liberty Wind will deliver reliable renewable power directly to New York via a high voltage direct current (HVDC) export cable to a grid interconnection point on Long Island. The Project’s transmission cable landfall location, onshore route, and installation methods have been selected and designed to avoid coastal and community impacts. The Project’s onshore cable will be buried entirely under existing roads.

Vineyard Wind is the leading US offshore wind developer, currently financing and developing an 800 MW offshore wind project that will be the nation’s first commercial-scale project in federal waters. Liberty Wind is backed by two of the world’s most successful and experienced offshore wind project developers and investors, Copenhagen Infrastructure Partners (CIP) and Avangrid Renewables

(together the “parent companies”), who also have experience developing HVDC transmission solutions. Liberty Wind also includes a collaboration with Anbaric Development Partners (ADP), a transmission developer with substantial experience and expertise developing submarine transmission lines in New York. This collaboration ensures Liberty Wind will provide New Yorkers a mature and viable transmission and interconnection solution in NYISO Zone K.

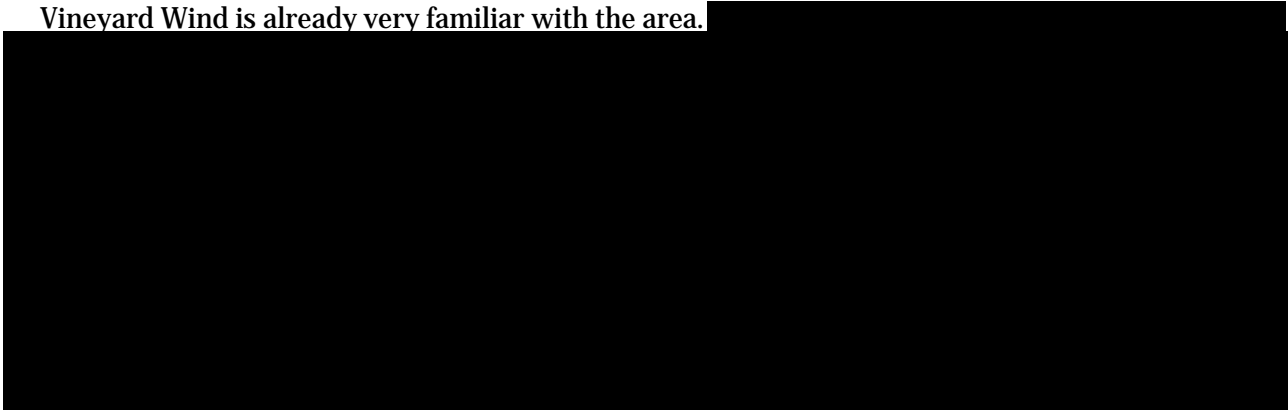
The Nation’s Largest Project is the Best Option For New York

This proposal discusses Project Three - the 1,200 MW proposal - which would make New York home to the nation’s largest offshore wind project and provide clean electricity for an estimated 750,000 New York households. Vineyard Wind recommends the 1,200 MW Liberty Wind project, as this size takes maximum advantage of economies of scale as well as the efficient and cost-effective use of HVDC transmission technology and the optimal injection point on Long Island. The 1,200 MW Project also ensures New York maximizes offshore wind supply chain investments and workforce development potential. The 1,200 MW Project also makes a substantial contribution to New York’s nation-leading offshore wind target while providing fixed price clean energy to New York ratepayers— all with no visual and minimal potential environmental impacts to New York residents. **Table 1-1** summarizes the key aspects and structure of the three size Liberty Wind proposals.



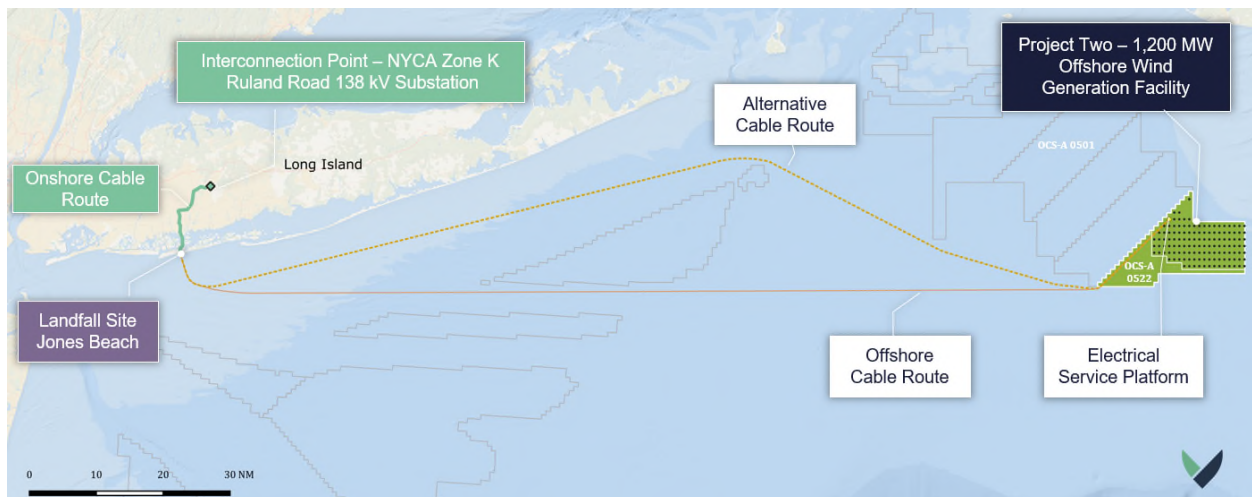
LIBERTY WIND PROJECT OVERVIEW

Liberty Wind's Offshore Wind Generation Facility will be located in federally designated Lease Area OCS-A 0522, located approximately 85 miles east of Montauk and over 30 miles from the nearest shore in Massachusetts. This area is south of Vineyard Wind's other lease area, Lease Area OCS-A 0501, where we are currently developing the nation's first commercial-scale offshore wind project. The proximity of the two projects is a considerable advantage in developing Liberty Wind, as Vineyard Wind is already very familiar with the area.



Liberty Wind's 1,200 MW of power will be delivered directly to the New York power grid via a 170-mile long HVDC subsea cable that makes landfall on Long Island under Jones Beach south of the Jones Beach State Park. The Project's cable route has previously been reviewed with the New York State Office of Parks, Recreation and Historic Preservation and will avoid nearby sensitive sand dunes and historic recreational resources further to the east as well as the sensitive habitats in the back bay area. The Project's onshore transmission route benefits from a well-advanced Article VII permit application for a project that has been re-purposed for Liberty Wind. The Injection Point and Delivery Point for Liberty Wind is in the New York Control Area (NYCA) at the Ruland Road 138 kV substation in Melville, New York on Long Island, in NYISO Zone K.

Figure 1.1-1 Key Project Component Locations



ROBUST AND WELL-DEVELOPED GRID CONNECTION TO NEW YORK

Recognizing that the transmission cable route and grid connection is one of the most challenging aspects of offshore wind development, Vineyard Wind has secured a well-designed and very mature interconnection solution for Liberty Wind through an innovative collaboration with ADP and its principals. ADP has already built over 1,300 MW of submarine transmission cables serving New York, including the 660 MW Neptune Regional Transmission System (the “Neptune project”). The Neptune project is an HVDC transmission project that was completed in 2007 ahead of time and under budget and demonstrates the viability of connecting HVDC transmission systems to Long Island’s grid.


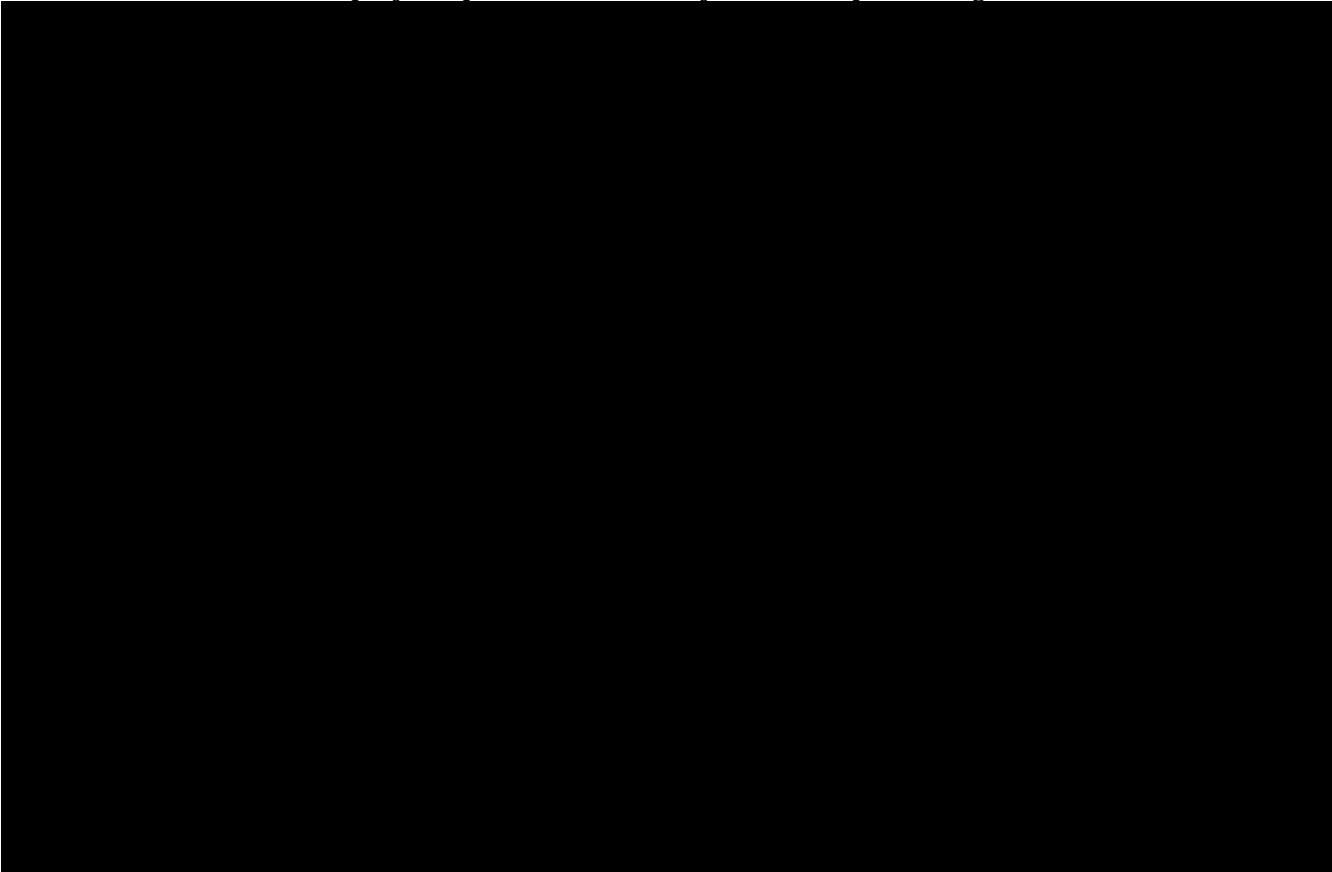
ADP has continued to develop additional transmission solutions on Long Island and has invested substantial effort and resources over the last five years to progress additional HVDC transmission solutions on Long Island. This work has led to the identification of a landfall location and cable route for Liberty Wind that is similar to that of the Neptune project. This landfall and cable route have been previously validated through extensive survey work, community outreach, a complete Article VII application with the New York Public Service Commission (NYPSC), and supportive commitments from New York state, county, and local governmental entities.

Vineyard Wind’s collaboration with ADP removes considerable risk from project delivery. Through ADP, Liberty Wind gains exclusive control of the identified favorable landfall location, cable route, interconnection points already far along the permitting and interconnection approval process. The Project also secures one of the best and most advanced interconnection solutions capable of injecting substantial renewable energy capacity into New York’s bulk power system.

Advanced Grid Connection Development

The viability of Liberty Wind’s transmission and interconnection solution is demonstrated by:

- ✓ ***Two advanced NYISO queue positions totaling 1,200 MW at Ruland Road substation — one of the best interconnection points on Long Island.*** Aside from the Ruland Road substation, few substations in New York City or on Long Island can handle injections of 800 MW or more of offshore wind energy without deliverability constraints and/or costly upgrades. Liberty Wind’s 1,200 MW proposal takes advantage of an interconnection solution that includes one interconnection request that has already fully progressed through NYISO’s interconnection process and another that is expected to qualify for NYISO’s 2019 Class Year.
- ✓ ***Thoroughly researched onshore cable route in the advanced stages of permitting.*** Geophysical surveys for the upland route, shown in **Figure 1.1-2**, have been completed, including locations of all underground utilities, boundaries, and wetland delineation, for construction plan development. The route has a complete Article VII environmental permitting application pending before the NYPSC, which is required to construct and operate a major electric transmission facility. The onshore route also includes a near-complete request to use New York State limited access highways pending before the New York State Department of Transportation (NYSDOT).

- 
- ✓ ***A viable cable route entirely using public roadways and utility rights-of-way.*** The cable route uses public roadways and utility rights-of-way (ROWs) for its entire length and was identified in consultation with county and town officials and NYSDOT officials; these consultations did not identify any reason why cable installation would not be feasible or allowable. Any roadways or surfaces disturbed during installation will be returned to their original condition.
 - ✓ ***Site control of the land for the onshore substation.*** An ADP project entity holds an option to lease a privately-owned parcel of land at 135 Ruland Road for the onshore substation. Layouts have demonstrated that the site has sufficient area to accommodate an onshore substation for a project up to 1,200 MW, subject to local permitting.
- 

Proven Grid Technology Enhances Reliability and Reduces Costs

Liberty Wind utilizes an HVDC transmission cable, which provides a larger carrying capacity than traditional alternating current cables, allowing more electricity to be delivered to New York ratepayers at a lower cost due to economies of scale. HVDC transmission systems also have lower overall losses than traditional AC transmission systems when transmitting over the long distances,

such as those required for Liberty Wind. Submarine HVDC transmission systems are well understood; two such systems are currently operating on Long Island. Additionally, Liberty Wind's HVDC transmission system and approach is similar to those already in use in many offshore platforms in Europe to serve either offshore wind projects and gas operations.

HVDC Transmission Enhances Electricity System Reliability in Adverse Conditions

Liberty Wind's HVDC transmission system also brings significant reliability, resiliency, and grid management advantages to Long Island and New York. The Project's HVDC system uses voltage source converter technology, which will allow Liberty Wind to respond to faults on the existing grid network and provide operational benefits in adverse grid conditions similar to those experienced during major storms.

\$652 MILLION IN ECONOMIC GROWTH AND JOB CREATION FOR NEW YORK

Liberty Wind is more than an offshore wind project, it is a commitment to New York and New Yorkers. The 1,200 MW Project would provide \$652 million in incremental economic benefits to Long Island, the Capital Region, and New York City, including:

- ✓ \$632 million in direct project development and construction-related expenditures utilizing New York-based suppliers, contractors, and labor, as well as investments in transmission and port infrastructure upgrades, all of which will establish and grow New York's offshore wind supply chain capabilities.
- ✓ \$20 million in direct funding for initiatives supporting New York offshore wind supply chain and workforce development and training, offshore wind research and development (R&D), which will promote New York's offshore wind future and ensure New York workers and businesses are at the forefront of the nation's rapidly emerging offshore wind industry, and community benefits.

Liberty Wind's commitments include, among others, establishing fabrication facilities for foundation transition pieces and electrical service platform (ESP) jacket foundations at one or more New York port facilities. This work will be done at one or more existing New York facilities upgraded by Liberty Wind. [REDACTED]

[REDACTED] Liberty Wind's use of any of these New York port options will create a skilled and experienced workforce and supply chain, all of which will establish New York as an attractive base for future offshore wind projects, facilitate further cost reductions for offshore wind, and sustain regional job creation and economic development.

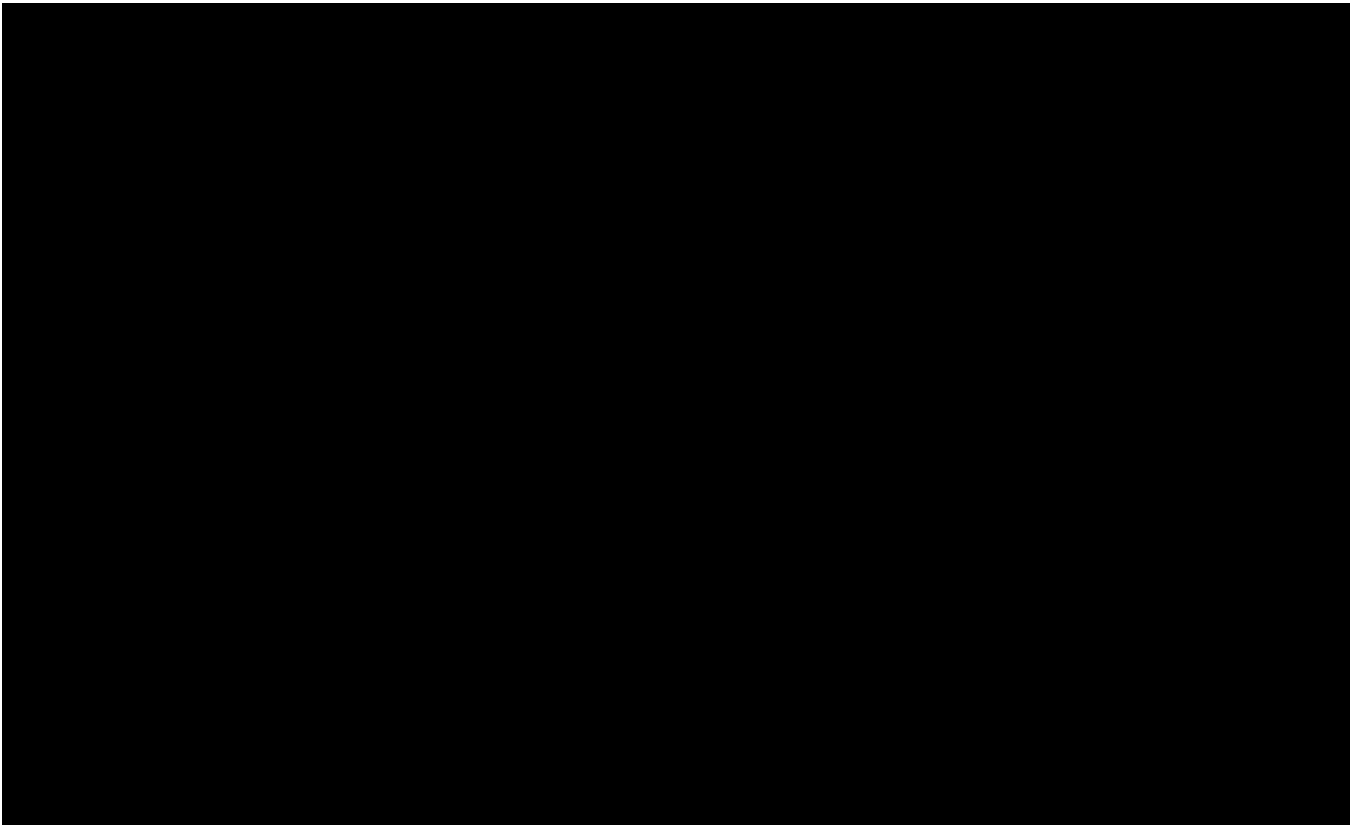
\$632 MILLION IN ECONOMIC BENEFITS USING NEW YORK PORTS, SUPPLIERS, AND LABOR

Liberty Wind will bring the offshore wind industry to New York through a commitment of \$632 million in direct payments for salaries, goods, and services across all parts of the project value chain, as shown in **Figure 1-1.3**.

These commitments will lead to:

- ✓ **Capital Region:** Foundation transition piece and ESP foundation fabrication and final outfitting capabilities at one or more New York ports;
- ✓ **Long Island:** Substantial construction-related expenditures on Long Island for the onshore cable route and grid connection; and
- ✓ **New York City:** Vineyard Wind and ADP establishing a new project office in New York City, putting the city on the world map as an offshore wind center, and contributing substantial economic activity through direct employment as well as professional and financing fees and services. Liberty Wind will also use New York based vessels and crews for several of the campaigns throughout the life of the project.

These commitments will establish and grow New York's offshore wind supply chain capabilities and position the state to serve future offshore wind projects.



Liberty Wind is committed to completing steel work fabrication and final outfitting of the Project's transition pieces at one or more New York ports, in coordination with NYSERDA. Vineyard Wind has executed an option lease agreement with the Port of Coeymans (Coeymans), located on the Hudson River 10 miles south of Albany for steel work fabrication and final outfitting of the Project's foundation transition pieces and the ESP jacket foundation. The agreement with Coeymans provides for investment in the port's facilities and infrastructure, and commitments for contracts, including salaries for construction-related jobs in the Capitol Region during construction.

These investments will establish Coeymans and potentially other New York ports, as well as its workers and contractors, as the state's first offshore wind-capable ports and workforce, enabling future offshore wind projects to utilize New York-based supply chain and labor while spurring additional investments across New York.

Figure 1.1-4 Steel Work for Foundation Components at Port of Coeymans



Construction Jobs on Long Island: Building the Onshore Transmission Cable and Grid Upgrades

This includes the work necessary to install the 18-mile long underground transmission cable from the landing at

Jones Beach to the substation at Ruland Road, along with restoration of the route to its original condition. The construction of the onshore HVDC converter station in Melville will also be completed by New York contractors. [REDACTED]

New York Banks and Advisory Services to Lead Project Financing

Liberty Wind will rely on New York-based financial institutions and advisors to secure project financing and look to New York-based companies to provide the many professional services needed to develop and finance a large project like Liberty Wind, including attorneys, accountants, consultants, engineers, and other professional services. Procuring these services will not only grow New York's offshore wind service sector, but also reinforce New York City as the center for offshore wind financing in the US.

New York City Project Office and Team

Immediately upon selection, Vineyard Wind will expand its presence in New York to deliver Liberty Wind, which includes opening a Project office in New York City to accommodate the entire Liberty Wind project development team, along with consultants and advisors, who will support the development, financing, construction, and operation of the Project.

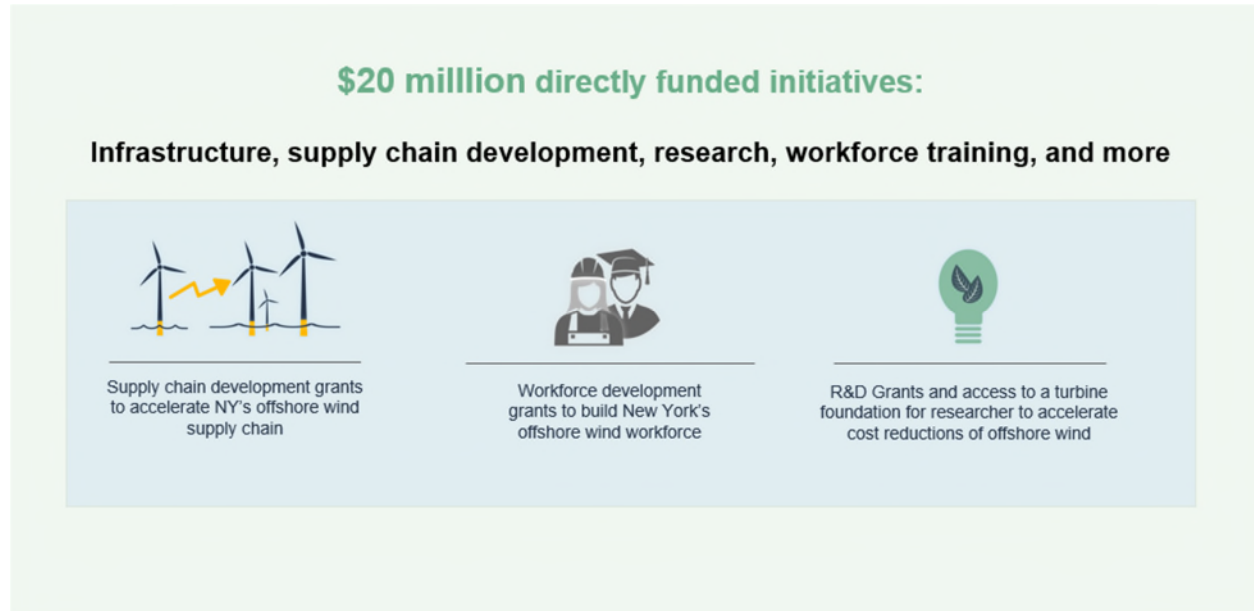
A Commitment to Union Labor

Liberty Wind is committed to using union labor for project construction activities, as evidenced by the signed letters provided to the New York State Building and Construction Trades Council, the Building and Construction Trades Council of Greater Capital Region, the Building and Construction Trades Council of Greater New York, and the Building and Construction Trades Council of Nassau/Suffolk in which we confirm our commitment to union labor. Liberty Wind welcomes the opportunity to work with New York's labor unions, and to submitting a plan for negotiating a Project Labor Agreement upon submission of the Project's federal permit application to the Bureau of Ocean Energy Management (BOEM). We are committed to making the Project a union project and to ensuring that New York union labor leads the nation's offshore wind workforce.

INVESTING \$20 MILLION IN NEW YORK'S OFFSHORE WIND FUTURE

The 1,200 MW Project includes a commitment of \$20 million in direct funding towards initiatives for New York businesses, communities, and workers to build, lead and sustain the state's new offshore wind industry, as shown in **Figure 1-1.4**. This total funding will be applied to the following initiatives in coordination with NYSERDA:

Figure 1.1-5 New York Offshore Wind Initiatives



Supply Chain Development Grants to Accelerate the Offshore Wind Supply Chain

Liberty Wind’s supply chain development grant program will help New York businesses – such as marine contractors, boat builders, and electrical equipment manufacturers — enter the offshore wind sector and encourage existing offshore wind supply chain to establish operations in New York. These grants will be used to offset capital expenditures such as business relocation costs, new equipment purchases, facility upgrades, or new facility construction in or near New York’s major ports. The potential impact of these grants will be enhanced by ensuring grant awards align with the supply chain needs of the Project.

Developing New York’s Offshore Wind Workforce

Liberty Wind will provide grants to government and non-profit agencies for workforce development and job training programs to educate New York’s next generation of offshore wind professionals and workers. This could include grants to the State University of New York (SUNY) at Stony Brook or SUNY Maritime College to educate and train a highly qualified workforce in the area of ship officers and crew, engineers, construction management, turbine technicians, and other skilled positions who will design, build, and manage the offshore wind farms serving New York and the Eastern Seaboard.

Facilitating and Funding Offshore Wind R&D

Liberty Wind will provide access to one of the Project’s turbine platforms for training and research activities. This will allow researchers to use the WTG to, for example, mount equipment that and engage in platform boat landing training. Liberty Wind is committed to working with NYSERDA to ensure this access is utilized in way that facilitates unique opportunities for R&D and workforce training.

In addition, Liberty Wind will provide funding to research organizations and universities such as the Advanced Energy Research and Technology Center at Stony Brook, in coordination with NYSERDA, to support and promote offshore wind-related R&D activities.

Direct Community Benefits

Vineyard Wind and ADP seek to be good corporate citizens and neighbors, and so are pleased to provide funding for locally-identified projects and initiatives in communities hosting the Project, such as Nassau County and the Town of Huntington. Funding could support improved access to Nassau County's parks and beaches, for example, or other initiatives identified by the local communities.

UNMATCHED LOCAL KNOW HOW

The Most Experienced and Capable Offshore Wind Team in the US

Liberty Wind will be built by the nation's most successful and experienced offshore wind development team. Vineyard Wind, its parent companies, and their affiliates are currently developing offshore wind projects in excess of 10,000 MW in seven countries across the world including the US, United Kingdom (UK), Germany, France, Canada, Taiwan, and Australia. The two most recent projects to go into operation are the 402 MW Veja Mate project in the German North Sea (2017) and the 350 MW Wikinger project in the Baltic Sea (2018). Two more projects-the 588 MW Beatrice Offshore Wind Farm in Scotland and the 714 MW East Anglia One offshore wind farm in the UK- are currently under construction.

Unparalleled Experiences from Developing the US' First Major Offshore Wind Project

Vineyard Wind is currently developing the first commercial-scale offshore wind project in the US - an 800 MW project scheduled to begin construction in 2019. The significant experience and knowledge gained in developing this project will be brought to bear in developing Liberty Wind, further ensuring successful delivery of the Project for New York.

Vineyard Wind's experience in permitting, contracting, and financing the nation's first large-scale project makes the team uniquely qualified to deliver New York's flagship offshore wind project, and bring the offshore wind industry to New York. Key accomplishments on Vineyard Wind's first project which demonstrate our ability to deliver for New York include:

- ✓ Significant progress towards securing federal, state, local, and tribal permits and permissions. Vineyard Wind is on track to receive all permits for its first project within 18 months of having submitted initial applications;
- ✓ Concluding contracts for key aspects of the project, including entering into lease agreements with local ports, and in the final stages of contracting for all major supply packages;
- ✓ Actively working to involve local workforce and businesses, through initiatives such as organizing training programs, sponsoring community college classes, and hosting "Supply Chain Forums";

- ✓ Entering into a first-in-the-nation, landmark agreement with the Natural Resources Defense Council, the National Wildlife Federation, and Conservation Law Foundation to provide enhanced protection of the critically endangered North Atlantic Right Whale;



- ✓ Entering a host community agreement (HCA) with the Town of Barnstable, which guarantees over \$16 million in property taxes and community payments over the life of the project; and
- ✓ Entering a ground-breaking, first-of-its-kind Community Benefits Agreement with a local, non-profit energy cooperative, ensuring that local communities are involved in project design from the start, and have the opportunity to benefit from the project in ways that the community itself identifies.

In sum, Vineyard Wind is the most experienced developer in the US for large-scale offshore wind projects and has demonstrated its commitment and ability to effectively utilize local supply chain and ports, while ensuring communities affected by our projects realize sustainable benefits.

Unrivaled Project Experience on Long Island and the New England Coast

Accomplishments from individual members of Vineyard Wind's and ADP's teams include several coastal infrastructure and offshore projects in the Northeast, from the southern New England coast to the shores of Long Island. Our teams possess intimate knowledge of the needs and concerns of coastal communities, due to established working relationships with leaders of Long Island county and local governments as well as historical and ongoing engagements with business, environmental, and labor communities on Long Island, in New York City, and throughout New York State; and will ensure that Liberty Wind is developed with minimal impact to ocean users and coastal communities.

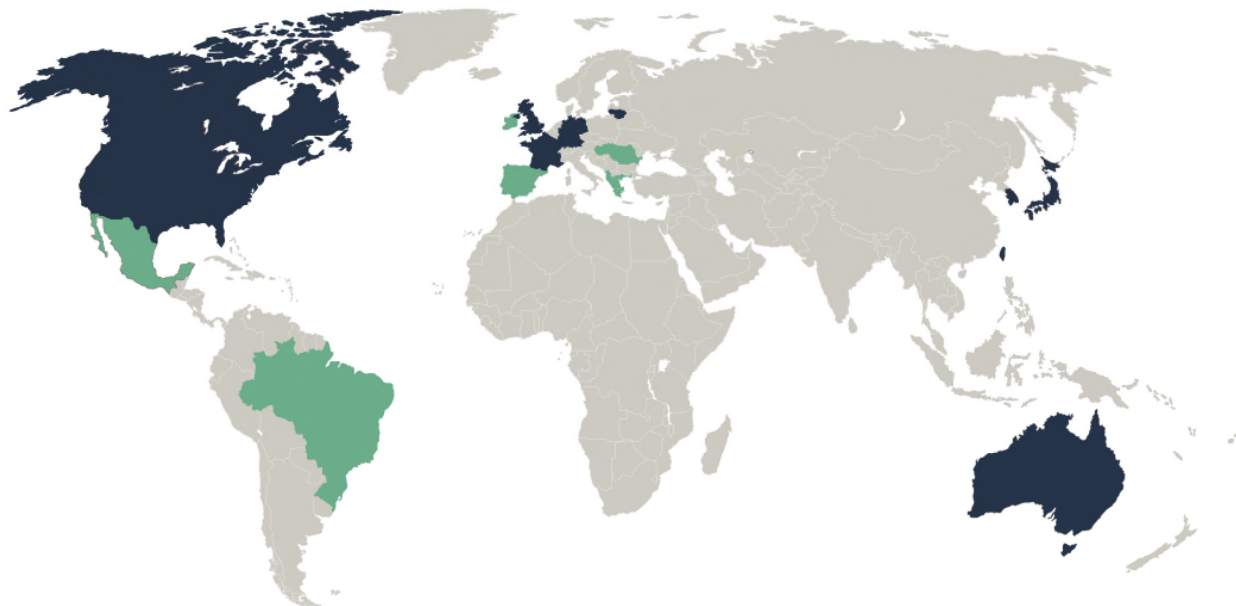
Renewable Energy and Wholesale Market Experience Across the US

The team backing Liberty Wind also includes individuals who have developed hundreds of megawatts of renewable energy projects across the US, ranging from small solar farms on Martha's Vineyard and ridgetop wind installations in the Northeast to some of the world's largest land-based wind projects in the western US. Vineyard Wind parent company Avangrid Renewables is also an active market participant in several ISO/RTO-administered markets, including NYISO.

GLOBAL EXPERIENCE AND WORLD CLASS EXPERTISE

Vineyard Wind, its parent companies, and affiliates have the experience and exceptional success in global and US offshore wind and transmission development necessary to ensure that the Project is delivered on time and on budget. **Figure 1.1-4** illustrates this global experience.

Figure 1.1-6 **Our Offshore (Blue) and Onshore Wind (Green) Experience**



Vineyard Wind's investors and technical team have global wind project experience, both offshore wind (navy) and onshore wind (teal).

Global Offshore Wind Development and Construction Experience

Vineyard Wind's team include some of the most experienced offshore wind professionals in the world. At present, the team includes dozens of experts with an impressive track record of developing, financing, constructing, and operating over 30 successful offshore wind projects. Liberty Wind will draw on this expertise, as well as New York experts in the areas of permitting and maritime professions, in developing the Project.

Extensive US and Global Offshore HVDC Transmission Systems Expertise

Vineyard Wind's parent companies, affiliates, and project partners have extensive experience in developing and operating offshore HVDC transmission projects. CIP operates the 900 MW Dolwin 3 HVDC offshore wind converter platform in the German North Sea in a joint-venture with leading transmission operator TenneT. ScottishPower, an affiliate of Iberdrola, has been analyzing the HVDC market for its East Anglia 3 project, a 1,200 MW offshore wind project in the North Sea, and constructed and operates the Western Link, a 262-mile 2,200 MW subsea HVDC cable in the Irish Sea. ADP was a lead member of the development team that designed and built the Neptune project, a 660 MW HVDC system linking Sayreville, New Jersey and Nassau County, Long Island and the Hudson Transmission Project, a 660 MW system using HVDC to a converter station at Ridgefield, New Jersey to the ConEdison substation at West 49th Street in Manhattan.

FINANCIALLY STRONG BACKERS READY TO INVEST IN LIBERTY WIND

Vineyard Wind is 50% owned by funds managed by CIP and 50% by Avangrid Renewables, two of the earliest and most experienced investors in US offshore wind. Both owners bring financial strength to Liberty Wind in addition to extensive experience in successfully organizing project finance for several offshore wind projects of similar complexity and scale. Vineyard Wind and its parent companies are now well underway with the construction financing process for Vineyard Wind's first 800 MW project. This process is expected to generate synergies when organizing construction financing for Liberty Wind.

Copenhagen Infrastructure Partners

CIP is a fund management company that specializes in energy infrastructure investments. Since its establishment in October 2012, CIP has raised four infrastructure funds investing in offshore wind and several other renewable technologies plus offshore power transmission assets in North America, Taiwan, Australia, the UK, and Germany, with total commitments of more than \$7 billion in equity. CIP has a "buy-and-hold" fund strategy, as its 40+ international private and institutional investors have investment horizons spanning more than 20 years. CIP's senior management have shaped the offshore wind industry through their involvement in a significant number of the world's largest offshore wind projects and transactions.

Avangrid Renewables

Avangrid Renewables is the third largest onshore wind developer in the US with operating assets in excess of \$10 billion and 6,000 MW across 21 states. Avangrid Renewables is a wholly owned subsidiary of Avangrid Inc. (Avangrid), a publicly traded company with an equity market capitalization of approximately \$15 billion.

Avangrid can raise equity capital from US public equity markets as well as from its majority owner Iberdrola S.A. (Iberdrola), the world's largest wind developer with a global installed wind capacity in excess of 15,000 MW. Iberdrola holds an 81.5% equity stake in Avangrid. Avangrid Renewables also has the ability to draw on key resources and experiences from ScottishPower Renewables Ltd (ScottishPower Renewables) which has considerable experience in developing, constructing, and operating offshore wind farms worldwide. ScottishPower Renewables is also part of the Iberdrola Group and an affiliate of Avangrid Renewables with responsibility for Iberdrola's offshore wind projects and activities in markets outside of the US.

Anbaric Development Partners

ADP is one of only a few companies that has successfully developed subsea transmission systems with onshore interconnection on the Eastern Seaboard. ADP is a US-based transmission developer, and a pioneer in the development of subsea transmission systems with onshore interconnection in New York. ADP has extensive experience in building transmission infrastructure, laying/burying seabed and onshore cable, and successfully pursuing permitting and stakeholder engagement in New York. ADP has created a joint venture with the \$146 billion (C\$193.9 billion) Ontario Teachers' Pension Plan Board – a leading infrastructure investor – to finance offshore wind transmission development and construction with permanent equity and debt financing.

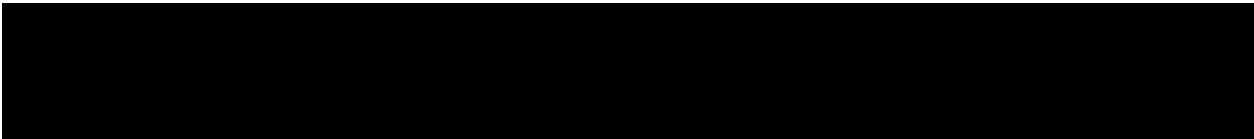
LIBERTY WIND MEETS OR EXCEEDS ALL THE RFP REQUIREMENTS

Liberty Wind's 1,200 MW proposal fulfills eligibility criteria and meets or exceeds all requirements of ORECRFP18-1. Liberty Wind is technically, financially, and commercially feasible; a fully cost-contained and cost-effective project; and will deliver the substantial economic and environmental benefits of offshore wind to New York.

The 1,200 MW Project proposal includes the following key distinguishing features:

- ✓ **Total incremental and contingent economic benefits of over \$700 million for New York and directly creating over 2,500 jobs in New York during development, construction, and operations.** Liberty Wind will establish New York as an offshore wind hub, growing vital supply chain capabilities in the state through direct payments of \$632 million in investments, salaries, goods, and services, particularly on Long Island and in the Capitol Region.
- ✓ **Investing in and staging key elements of the Project from one or more New York port facilities.** Vineyard Wind has secured an option lease agreement with the Port of Coeymans, which will ensure that the Project invests in and utilize one or more New York ports for steel work fabrication and final outfitting of the Project's transition pieces and ESP foundation.
- ✓ **\$20 million in funding initiatives for New York businesses, communities, and workers to join and directly benefit from the offshore wind industry.** Funding will be provided for port infrastructure and facility upgrades to equip New York to serve the offshore wind industry; supply chain development grants to attract key supply chain manufacturers, funding for workforce training; and offshore wind R&D. Initiatives will help New York companies take create or advantage of significant business opportunities and allow workers to access the many quality jobs that will be created in the years ahead.
- ✓ **1,200 MW of clean energy delivered directly to the New York grid at an optimal connection point on Long Island.** Liberty Wind will interconnect at one of the few interconnection points on Long Island capable of handling an injection of more than 800 MW. The Project's underground cable route and interconnection point are far advanced in the permitting and interconnection process, and the Project's transmission solution will enhance the reliability of Long Island's grid.
- ✓ **Project development and financing based in New York.** Upon selection and contract award under this procurement, Liberty Wind will open a Project office in New York City and hire the professional staff that will complete the Project's development, construction, commissioning, and start of commercial operations. The Project's financing will rely on New York-based banks and advisory services.

- ✓ ***A collaboration that combines the strongest US offshore wind team with proven Long Island independent transmission development expertise***, ensuring on-time and on-budget project delivery along with the best prices for New York ratepayers.
- ✓ ***The most advanced US offshore wind engineering and logistics concept*** that builds on investments in, synergies with, and learnings from Vineyard Wind's first 800 MW project. The first 800 MW project's advanced stage of development- including permitting, engineering, procurement, construction and contracting, as well as financing- provides invaluable and unparalleled knowledge and experience in US offshore wind project development. This experience will translate to lower risks and costs for Liberty Wind that, when coupled with the Project's well-developed onshore transmission and interconnection component, make Liberty Wind the most advanced and viable proposal for NYSERDA.
- ✓ ***No viewshed impacts to New York's coastal communities***, as the location of the turbines are far enough over the horizon that they will not be visible from any shoreline in New York. Additionally, the Project's onshore transmission cable will be entirely underground from the Jones Beach landfall location to the Ruland Road substation, thereby minimizing potential impacts for local communities and the environment.

- 
- ✓ ***Abundant clean power improving reliability*** at times when New York's energy system is most strained, reducing winter price volatility, and stabilizing energy prices.
 - ✓ ***Contributing to clean energy objectives and reducing greenhouse gas emissions by displacing up to 2.5 million tons of carbon dioxide*** annually and providing clean electricity for an estimated 750,000 New York households. Liberty Wind's 1,200 MW project would also make a significant contribution towards meeting Governor Cuomo's 9,000 MW of offshore wind goal.

The country's leading offshore wind developer and the most experienced HVDC transmission developer in New York are ready to deliver an offshore wind project designed specifically for New York. Liberty Wind will kick-start New York's offshore wind future with the nation's largest offshore wind project, spur significant utilization of, and investments in, New York infrastructure, businesses, and workers, while optimizing the use of the limited transmission and interconnection availability on Long Island. The Project will do this all while minimizing potential impacts on New York's coastal and other affected interests and communities.

Vineyard Wind welcomes the opportunity to discuss the Proposal with you and we thank you for your consideration.



LIBERTY WIND

SECTION 2 - PROPOSER EXPERIENCE

Proposal for New York State Energy Research and Development Authority in response to Request For Proposals for Purchase of Offshore Wind Renewable Energy Certificates



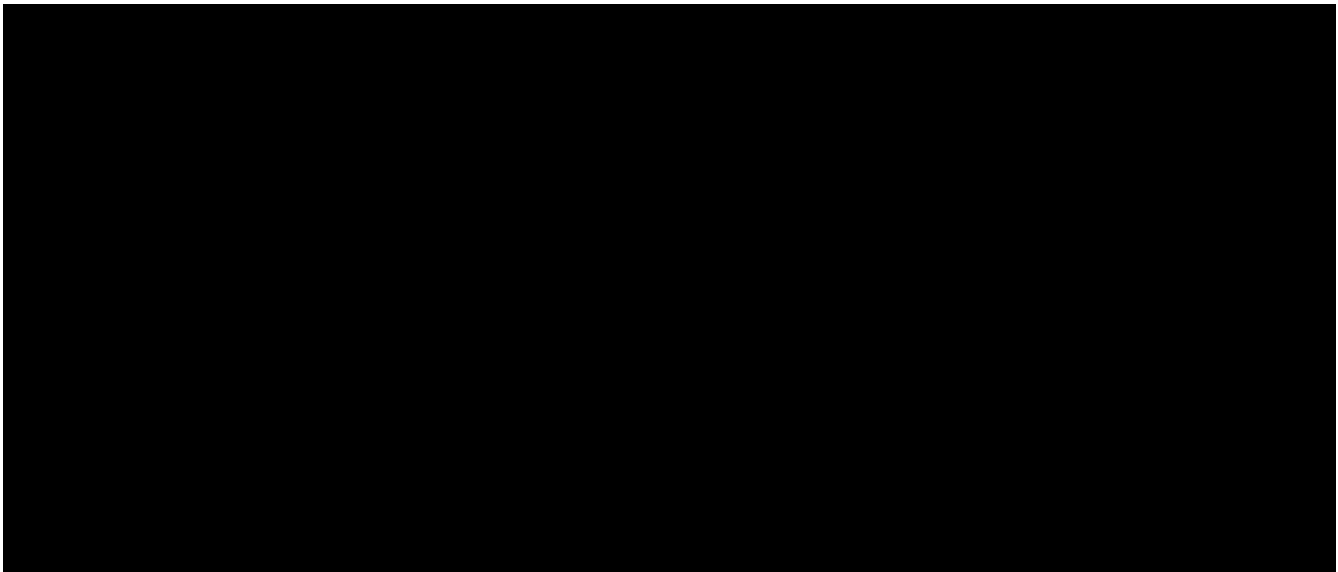
Photo: Beatrice offshore wind farm

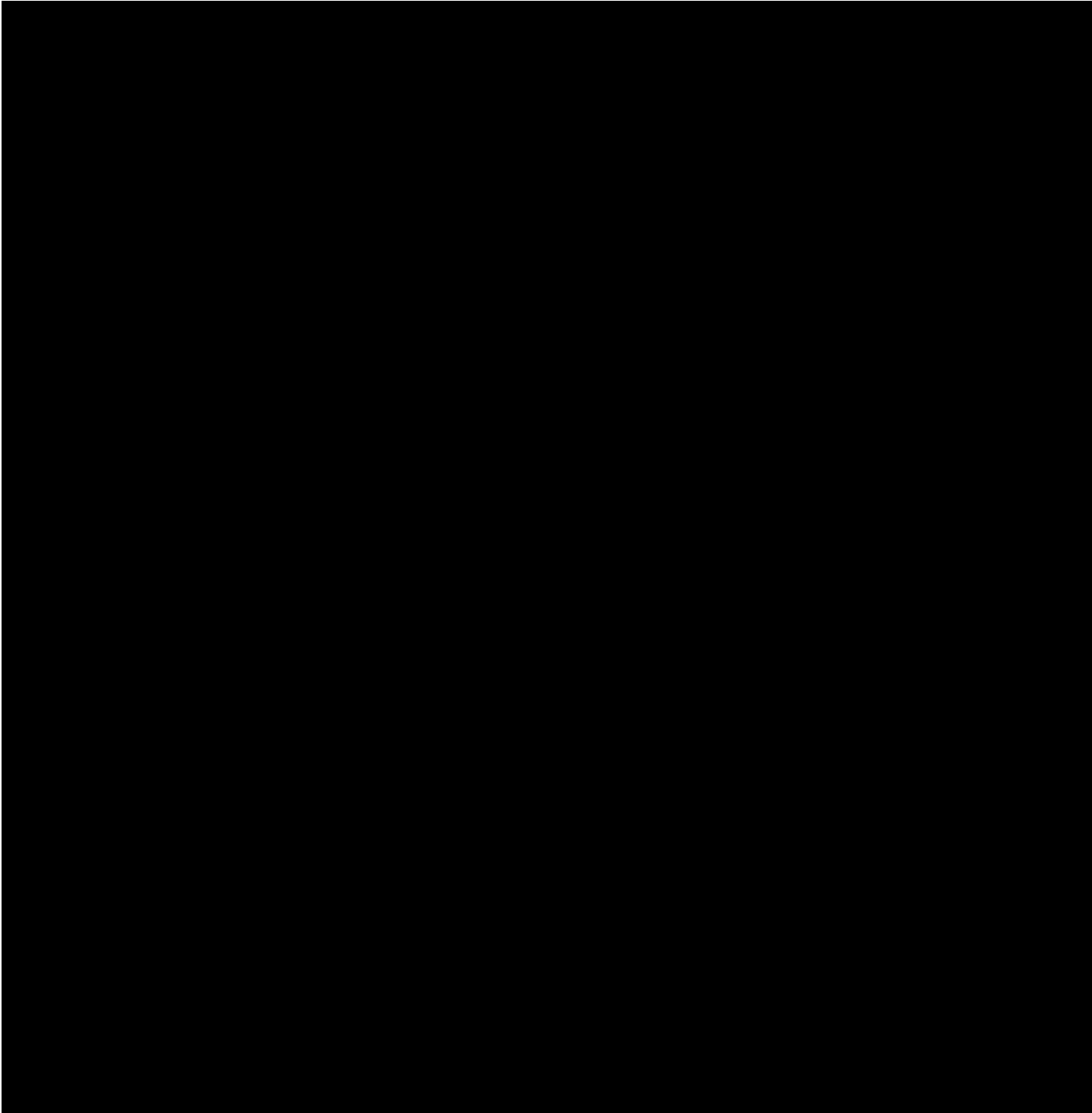
SECTION 2 PROPOSER EXPERIENCE

Proposers are required to demonstrate project experience and management capability to successfully develop and operate the Project proposed. NYSERDA is interested in project teams that have demonstrated success in developing generating facilities of similar size and complexity and can demonstrate an ability to work together effectively to bring the Project to commercial operation in a timely fashion. Proposers are required to provide the following information with their Proposal:

- 1. An organizational chart for the Project that lists the Project participants and identifies the corporate structure, including general and limited partners.*
-

Vineyard Wind LLC's (Vineyard Wind) corporate structure is shown in the organizational chart provided as **Figure 2.1-1** below. This chart portrays Vineyard Wind's shareholder companies (i.e., parent companies), which are described in more detail in **Section 6**. Please refer to **Figure 2.3-1** for a key personnel management team organizational chart.



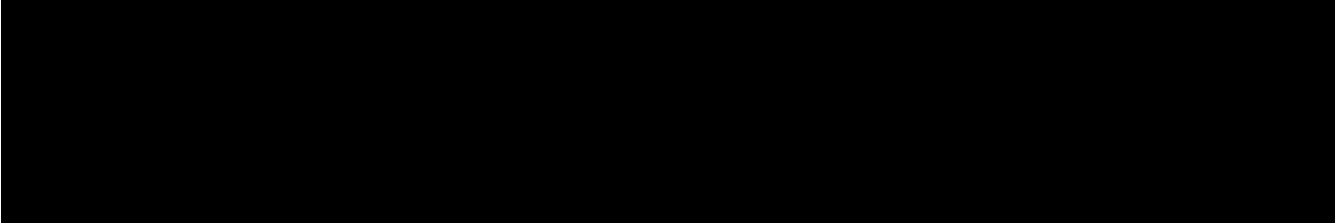


-
2. *Statements that list the specific experience of Proposers and each of the Project participants (including, when applicable, Proposers, partners, and proposed contractors), in developing, financing, owning, and operating generating and transmission facilities, other projects of similar type, size and technology, and any evidence that the Project participants have worked jointly on other projects.*
-

Liberty Wind brings together Vineyard Wind and ADP to develop the first large-scale offshore wind project for New York. Their partnership creates a strong and complementary combination of expertise and experience in US and international offshore wind development together with solid and extensive experience developing and operating offshore and onshore transmission systems in New York.

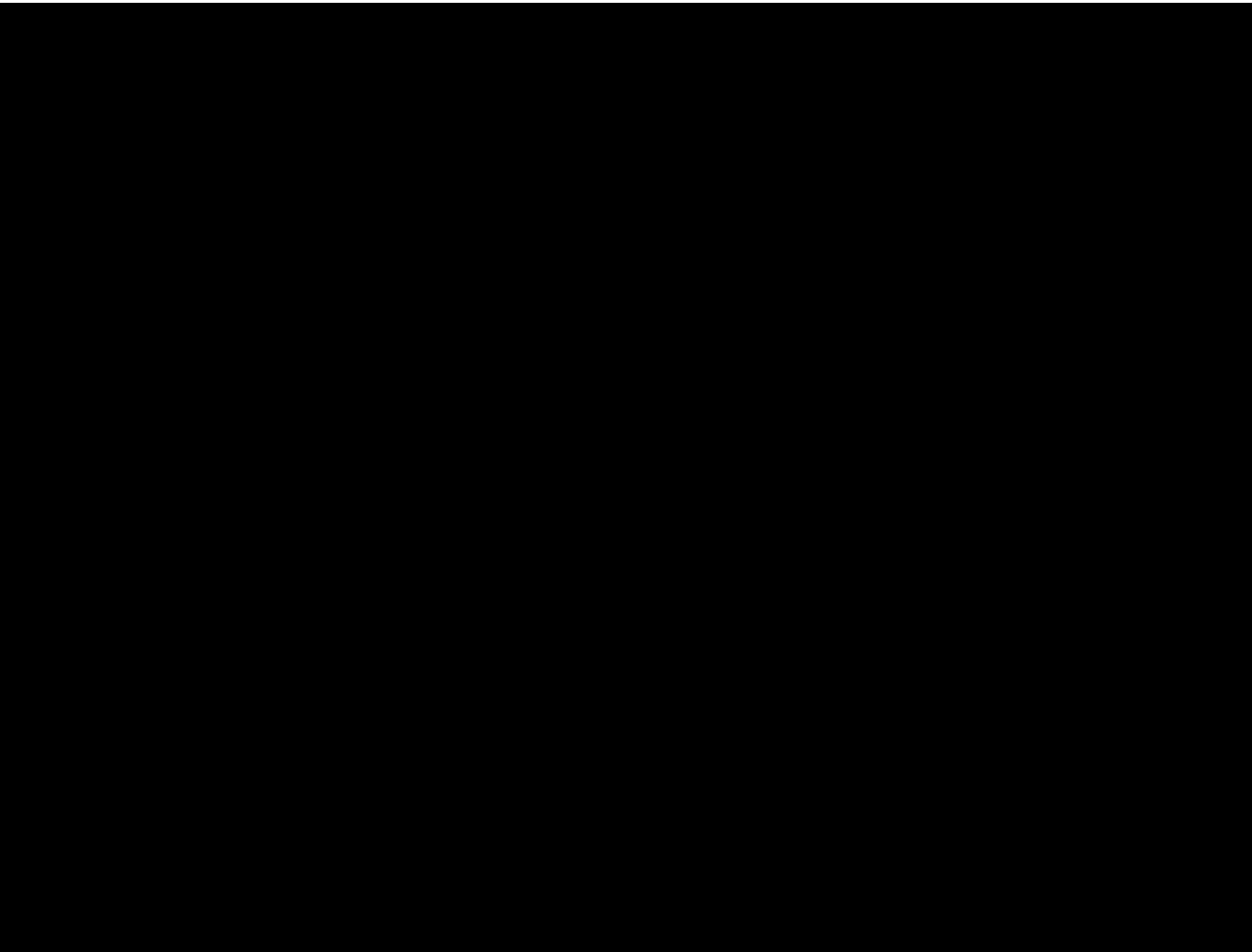
Vineyard Wind was established in 2009 (at the time called Offshore MW) and is owned by Copenhagen Infrastructure Partners (CIP) (through two investment funds CI II and CI III) and Avangrid Renewables LLC (Avangrid Renewables), a subsidiary of Avangrid Inc. (Avangrid). Each parent company has equal ownership (i.e., 50% equity ownership each) of Vineyard Wind. This ownership structure allows Vineyard Wind to take advantage of the substantial experience and capability that each parent company has to offer.

Vineyard Wind's team of industry experts has a long track record of developing offshore and onshore wind projects throughout the US and Europe; the company is also currently progressing its first 800 MW project through final development and creating a US track record in development, permitting, procurement, and financing along the way.



CIP and Avangrid Renewables each have recent experience in the construction of offshore wind projects of a similar type, size, and technology as the Project, including operating projects of 389 MW (West of Duddon Sands, UK), 402 MW (Veja Mate, Germany), 588 MW (Beatrice, UK), and 350 MW (Wikinger, Germany); and another 714 MW project (East Anglia 1, UK) currently under construction

The Vineyard Wind team is comprised of personnel provided by the parent companies, local staff with expertise in offshore wind development, and consultants selected to ensure a well-rounded team with the skillset required to develop, finance, construct, and operate offshore wind projects and transmission infrastructure in New York. **Figure 2.2-1** provides an overview of the Project team's offshore wind experience.



ADP, through its founder and team, has recent experience in the development and construction of transmission projects of a similar type, size, and technology as that required for the Project. Through other Anbaric LLC-related entities (as described below), members of the ADP team have previously helped develop two major high voltage direct current (HVDC) transmission lines from New Jersey to New York. The first project, the Neptune Regional Transmission System (the “Neptune project”), was completed in 2007 ahead of schedule and under budget- demonstrating the feasibility of connecting HVDC transmission systems to Long Island’s grid. The second project is the Hudson Transmission Project (the “Hudson project”), which was completed in 2013, and runs to Manhattan. ADP’s founder, Edward N. Krapels, has also been in the transmission development business since 1999.

ADP has also been involved in the substantial effort to progress the Poseidon Transmission Project (the “Poseidon project”), an HVDC transmission project with a similar landfall location and onshore cable route as the Neptune project. The viability of the Poseidon project has been validated through extensive survey work, community outreach, a mature Article VII application, and supportive commitments from New York State county, and local governmental entities. The Poseidon project is being re-purposed for Liberty Wind, as further described in **Sections 3, 7, and 8**.

COPENHAGEN INFRASTRUCTURE PARTNERS

CIP has gained market-leading competencies and experience developing a number of offshore wind projects in Europe. CIP's senior partners have been involved in a significant proportion of offshore wind projects and transactions globally, which represent some of the largest and most complex projects within the energy infrastructure investment universe. Today, CIP is the only offshore wind developer in the world to have projects in development on four continents- America, Europe, Asia and Australia.

CIP provides management oversight, bringing rigor to the evaluation of the assumptions used to design and develop the Project, in addition to providing access to funds for financing the Project's construction and operation. Moreover, CIP has extensive experience in project financing, having financed over a dozen offshore and onshore wind, solar, and biomass projects as well as other clean energy investments.

Recent and notable offshore wind achievements include delivery of the Veja Mate project in record time. The project was completed four months ahead of schedule despite having to install 67 foundations and 6 MW wind turbine generators (WTG) under challenging conditions almost 60 miles (mi) from shore and in water depths of up to 135 feet. In the process, the team set several other world records, including the first use of the world's largest installation vessel (*Seajacks Scyllia*) and installing a 1,300 ton monopile - the largest monopile foundation ever installed.

Other notable experience includes financing the construction of the 900 MW DoWin3 Offshore Wind Farm Connection in Germany – an offshore HVDC transmission platform that was successfully completed in September 2018 when it began exporting power from two offshore wind farms. The platform is one out of nine HVDC systems in the German North Sea, constructed and operated by TenneT, which exports more than 6,000 MW into the onshore grid. The converter platform is located approximately 31 mi off the coast of the German North Sea coast.

AVANGRID RENEWABLES

Avangrid Renewables is the third largest developer of onshore wind projects in the US. In New York, Avangrid Renewables has successfully completed three onshore wind projects and has extensive experience operating wind projects in the New York Control Area (NYCA) as a market participant. The company is also in full compliance with North American Electric Reliability Corporation and New York Independent System Operator (NYISO) requirements for maintaining the security and reliability of its operations in its National Control Center (NCC) in Portland, Oregon.

Avangrid Renewables is a wholly owned subsidiary of Avangrid Inc., which has Iberdrola SA as its majority shareholder. This enables Avangrid Renewables to draw on resources and benefit from the experience of numerous affiliates, such as Avangrid Networks and ScottishPower Renewable Energy Ltd. (ScottishPower Renewables). These affiliates have substantial expertise in offshore and onshore wind development, transmission project development, finance, construction, and operating experience (including market participant experience) in the NYCA. Further details on the corporate relationship between Avangrid Renewables and its affiliates are provided in **Section 6**, and Avangrid Renewables' capabilities are further detailed below.

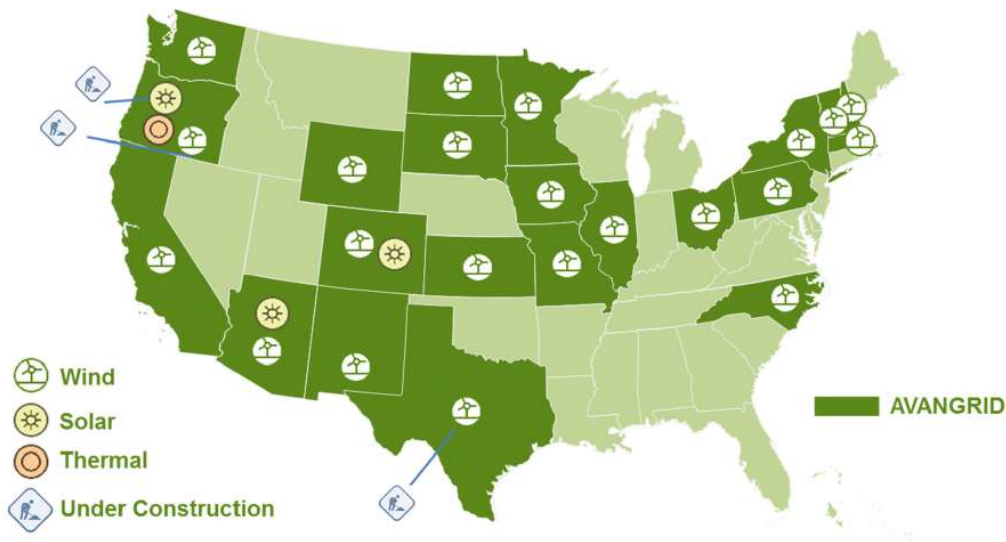
Development and Construction: Avangrid Renewables is a leading renewable energy developer in the US, pursuing greenfield projects, repowering projects, and acquisitions. The company currently has more than 25,000 MW of both wind and solar projects under active development. Avangrid Renewables has developed, constructed, and currently operates three wind projects in New York (see **Table 2.4-1**). Avangrid also has several hundred megawatts of New York projects in the advanced development stage, including both wind and solar.

Origination: Avangrid Renewables has a wide and varied customer base that includes commercial and industrial end-use customers, public utility districts, investor-owned utilities, electric cooperatives, and federal power marketing administrations. In NYCA, Avangrid Renewables has entered into five long-term renewable energy credit (REC) sales agreements with NYSERDA.

Operations and Maintenance: Avangrid Renewables' operations and maintenance (O&M) group currently operates 24/7 to oversee the operation of the company's 6,500 MW of installed renewable capacity in the US. The company has also developed in-house expertise for the maintenance of its project fleet; staff is present at each facility, providing balance-of-plant O&M, substation oversight, and maintaining an inventory of spare parts and equipment.

National Control Center: In early 2010, Avangrid Renewables launched its 24/7 NCC in Portland, Oregon. Avangrid Renewables uses the most sophisticated technology available to lead the industry in asset-monitoring and system control and has the ability to control every turbine under its management across North America. The company's expert technicians can troubleshoot 24/7, adjust turbine activity to comply with local grid demands, shut down individual turbines for safety or reliability concerns, and manage turbine output for maximum efficiencies.

Diverse Asset Base: The map in **Figure 2.2-2** illustrates Avangrid Renewables' combined wind, solar, biomass, gas-fired power plants, and natural gas storage facilities. The geographic diversity of the project fleet allows the company to optimize lessons learned across the country and maximize each project's generation capabilities.

Figure 2.2-2 Map of Avangrid Renewables Assets in the US (December 2017)

AVANGRID NETWORKS

Avangrid Networks is focused on the transmission and distribution of electricity and natural gas principally through eight regulated electric and natural gas utilities, serving approximately 3.2 million customers in New York and New England. Vineyard Wind and Anbaric will be supported by Avangrid Networks through its shared service employees, who have significant experience working on similar successful transmission projects, including the Central Maine Power Company's \$1.4 billion Maine Power Reliability projects, which have an impressive on-schedule and on-budget record.

SCOTTISHPOWER RENEWABLES

ScottishPower Renewables has experience in the development, construction, ownership, and operation of offshore wind farms, and is responsible for Iberdola's offshore wind projects in Europe, including:

- West of Duddon Sands, UK – 389 MW project completed in 2014;
- Wikinger, Germany – 350 MW project completed in October 2018;
- East Anglia One, UK – 714 MW project began construction in 2016;
- East Anglia Three, UK – 1,200 MW project in development, planned with HVDC offshore electrical service platform(s);
- 2,400 MW of projects currently in development across the UK, Germany, and France.

ANBARIC

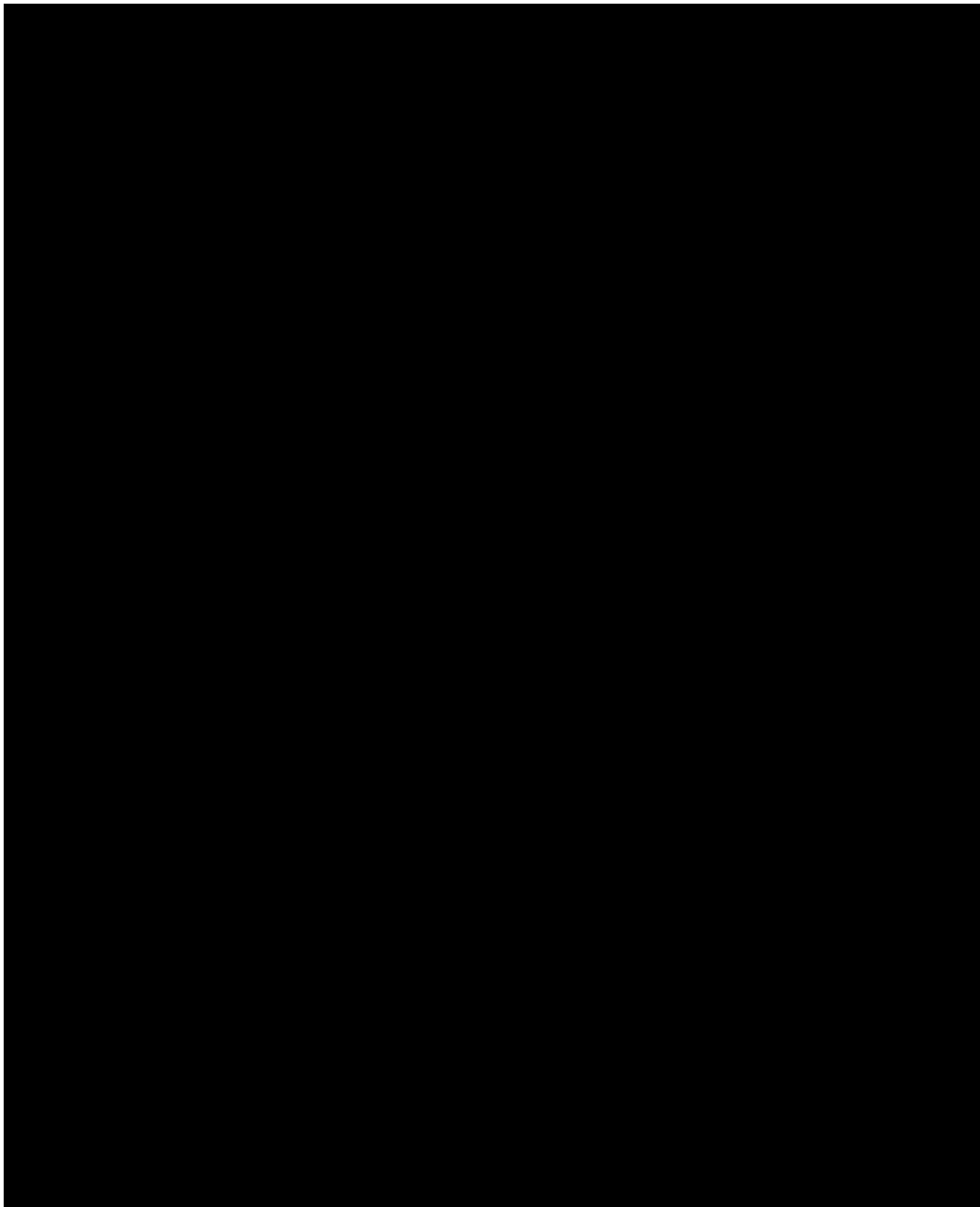
Anbaric LLC (Anbaric) is an experienced developer of transmission projects in New York and New Jersey and has been a partner in several different investor combinations. Between 2004 to 2016, Anbaric was a partner in three development entities funded by various private equity groups, including: Atlantic Energy Partners, which developed the Neptune project; Hudson Transmission Partners, which developed the Hudson project; and Anbaric Northeast Transmission Development Co., which has initiated a number of projects, some of which are still under development by others. In 2017, Anbaric AP3 LLC (an Anbaric-related entity) founded ADP, in a joint venture with OTPP.

The Neptune project is a 660 MW (500 kV) HVDC submarine electric transmission cable that connects power generation resources in the PJM system to electricity consumers on Long Island. The cable extends 65 mi from the First Energy substation in Sayreville, New Jersey to the Long Island Power Authority's Newbridge Road substation in Nassau County, New York. This project was completed in the summer of 2007, ahead of schedule and under budget. By creating a system-to-system connection between PJM and NYISO and drawing its power supply from the PJM grid, rather than from an individual generator, the Neptune project provides capacity and energy in a more flexible and reliable manner than new generating facilities, whatever their fuel source, on Long Island. This saves Long Island ratepayers money, increases capacity, and diversifies electricity sources without the local impacts associated with new power generation. [REDACTED]

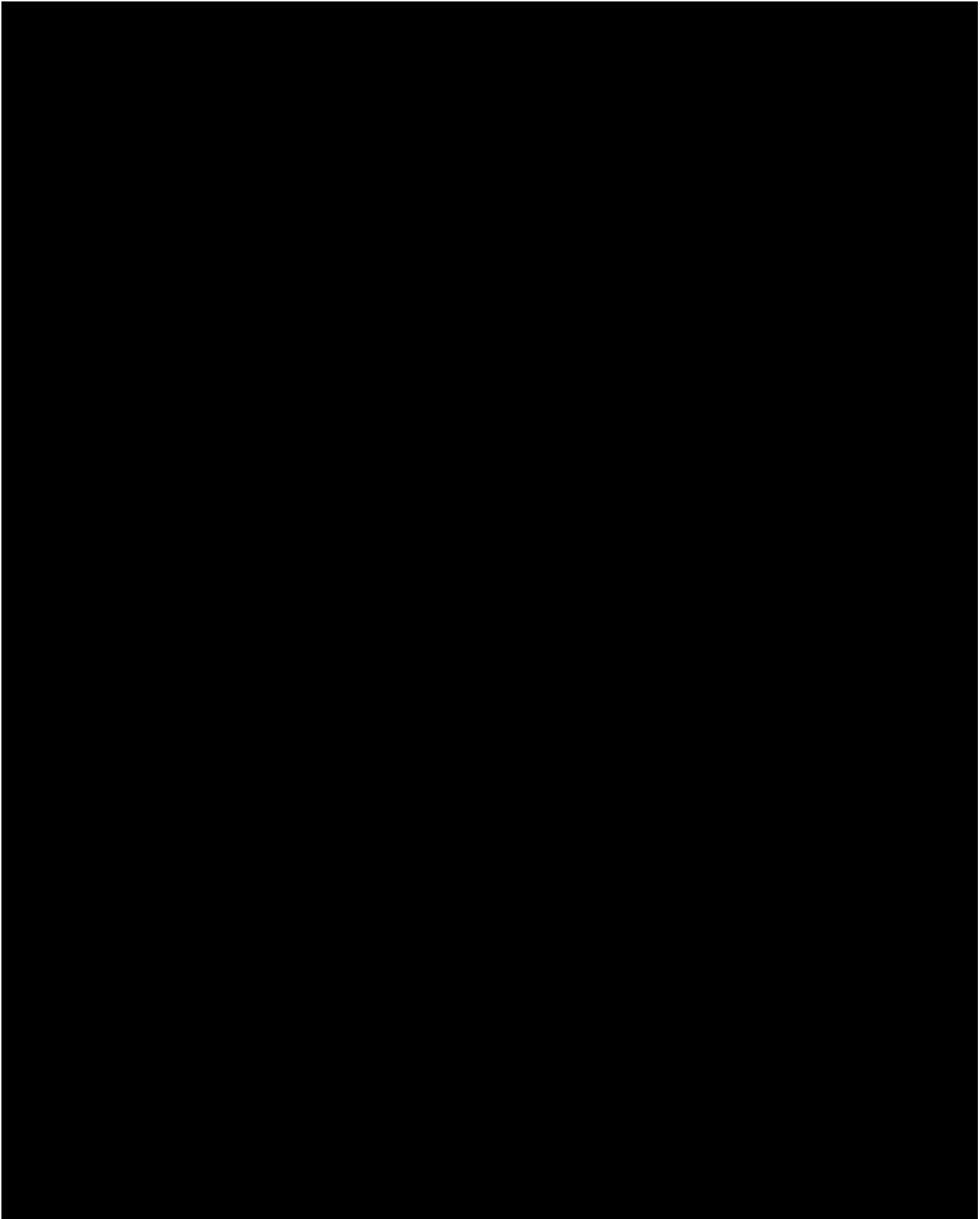
The Hudson project is a 660 MW electric transmission link between New York City and PJM Interconnection, which provides a new source of electric power for the New York City customers of the New York Power Authority (NYPA) and has the ability to offer New York City access to renewable resources throughout PJM. The Hudson project has back-to-back converter stations in Ridgefield, New Jersey and connects to the New York City grid at Con Edison's West 49th Street substation via a 345kV AC cable installed underground in railroad rights-of-way in Bergen County and beneath the Hudson River. Anbaric and its partners in the Hudson project secured financing, completed permitting, obtained regulatory approvals, and completed construction in time for commercial operation to begin in the summer of 2013.

KEY PARTNERS & CONSULTANTS

Vineyard Wind and Anbaric have engaged several New York-based consultants and partners to support early offshore wind and transmission project development, specifically for Liberty Wind, as shown in **Table 2.2-1**.



In addition to New York-based consultants and partners, Vineyard Wind has engaged several consultants and partners to support offshore wind project development as listed in **Table 2.2-2** below.

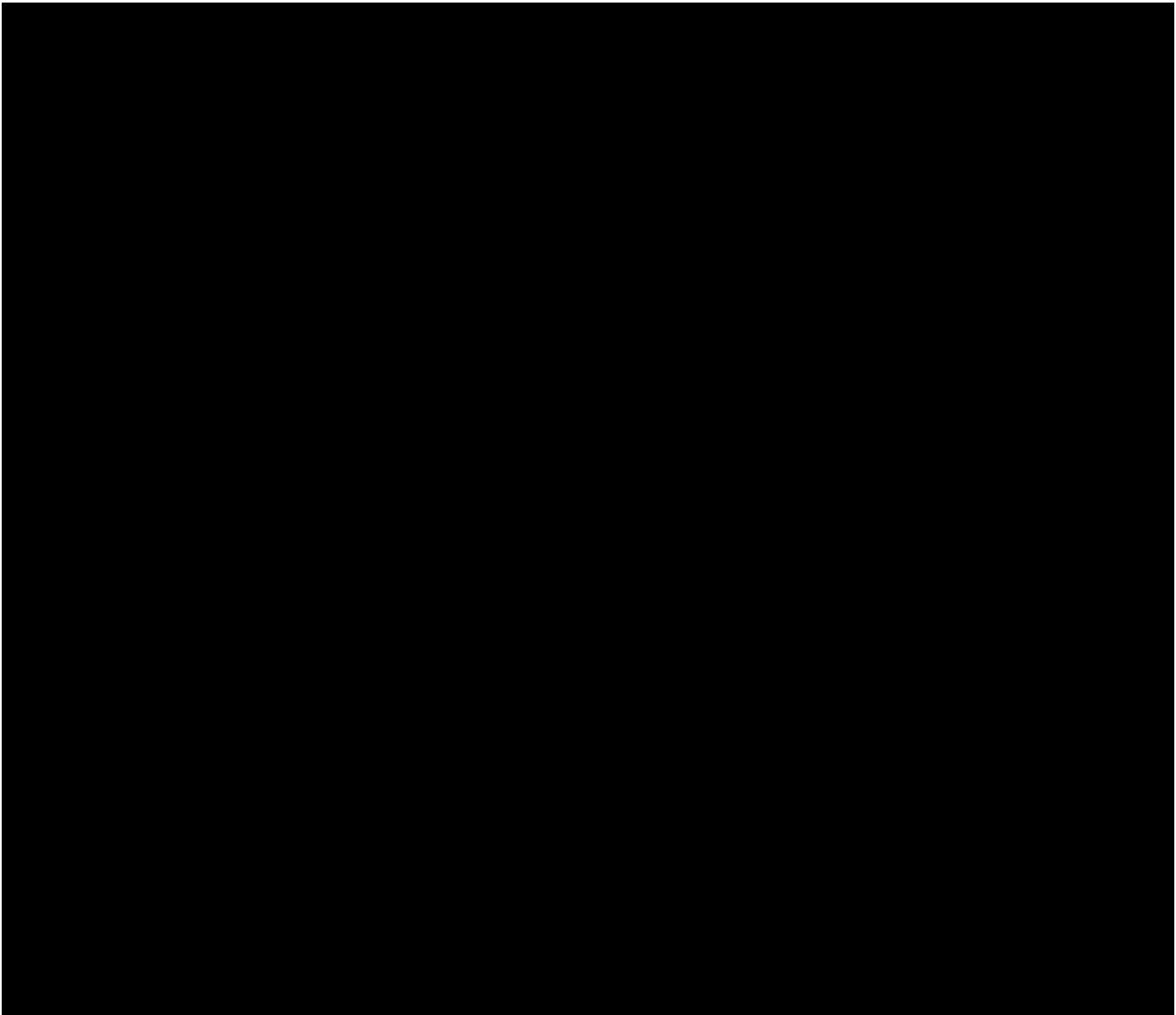


-
3. *A management chart that lists the key personnel dedicated to this Project and resumes of the key personnel. Key personnel of Proposer's development team having substantial Project management responsibilities must have:*
- a) Successfully developed and/or operated one or more projects of similar size or complexity or requiring similar skill sets; and*
 - b) Experience in financing power generation projects (or have the financial means to finance the Project on Proposer's balance sheet).*
-

Vineyard Wind Team

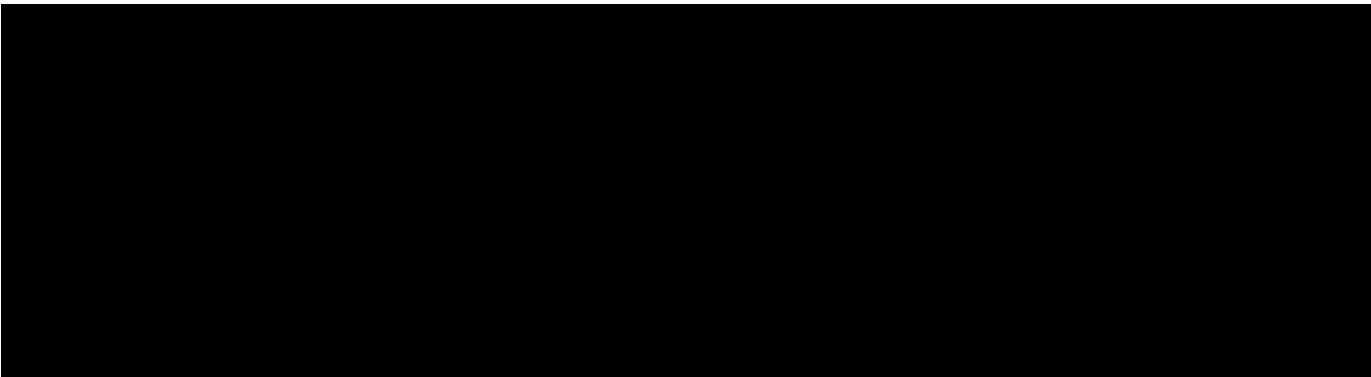
Vineyard Wind has assembled a highly qualified and experienced team for the Project. Rather uniquely, all members of the Vineyard Wind management team share a history of more than 10 years of working together seamlessly, as colleagues at prior employers, on offshore wind projects throughout Europe, Canada, and the US (see **Figure 2.3-1**).

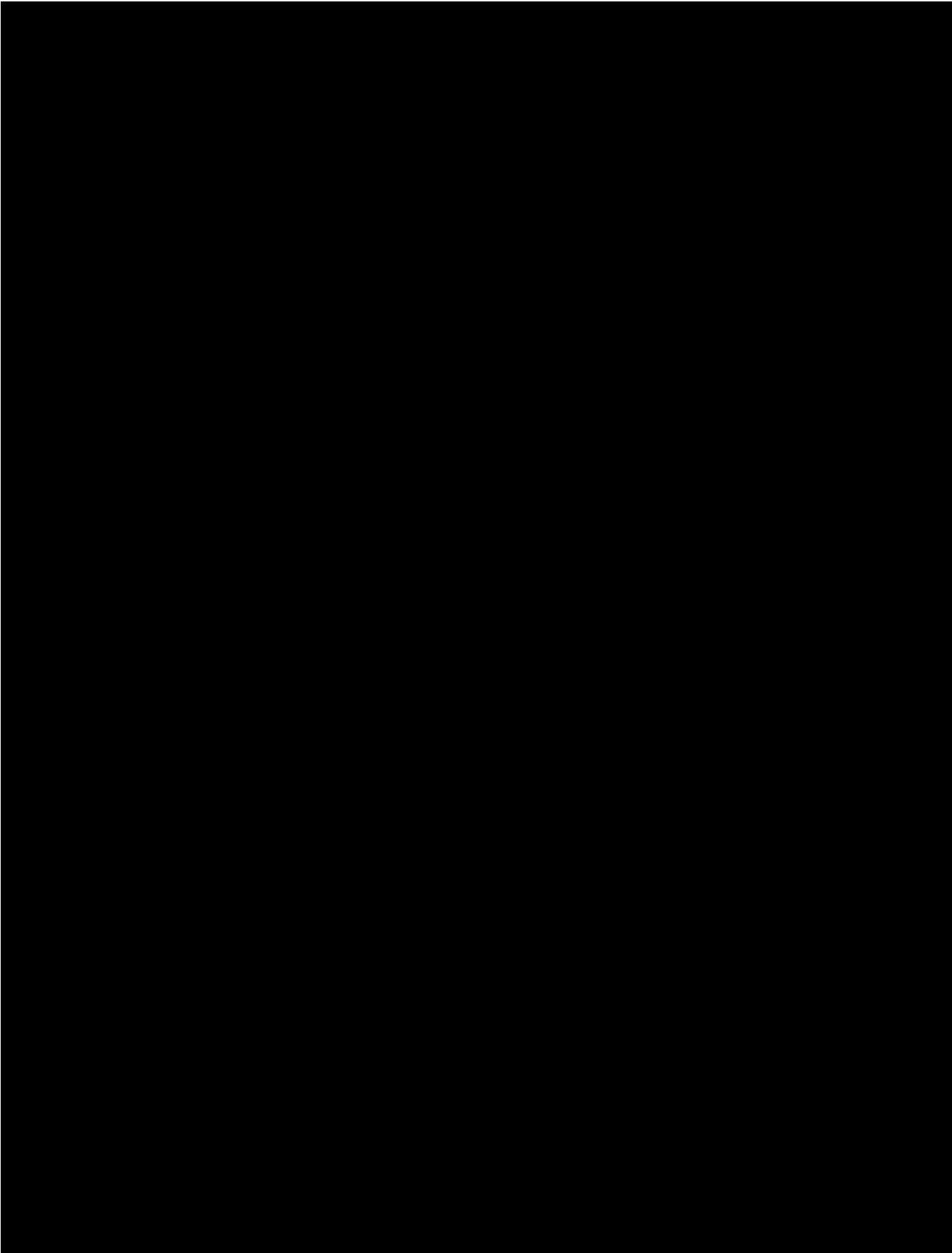
Vineyard Wind's management team is committed and dedicated to the Project. The leadership team is based in the US and the full resources of the parent companies are available to support the team in successfully executing the Project.

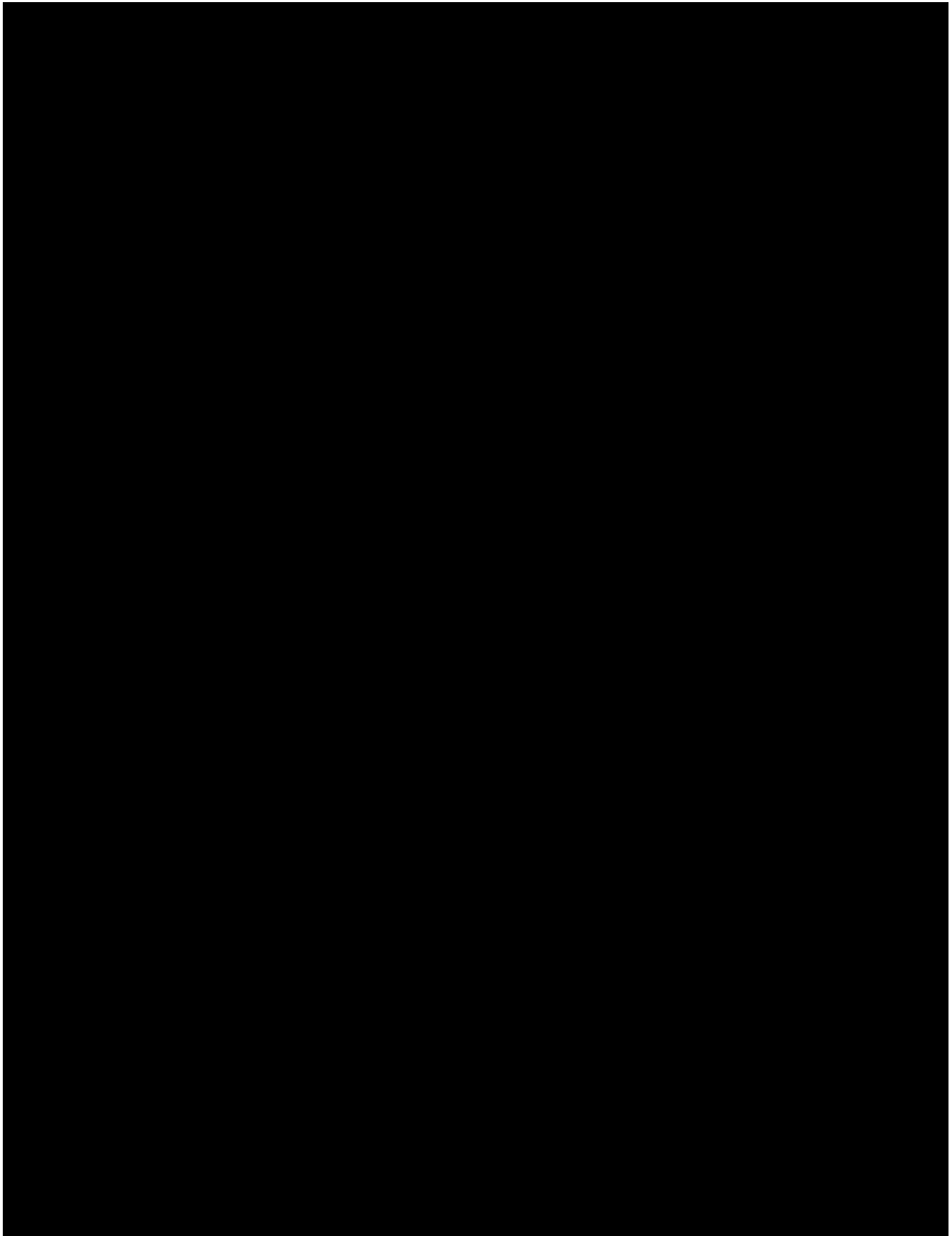


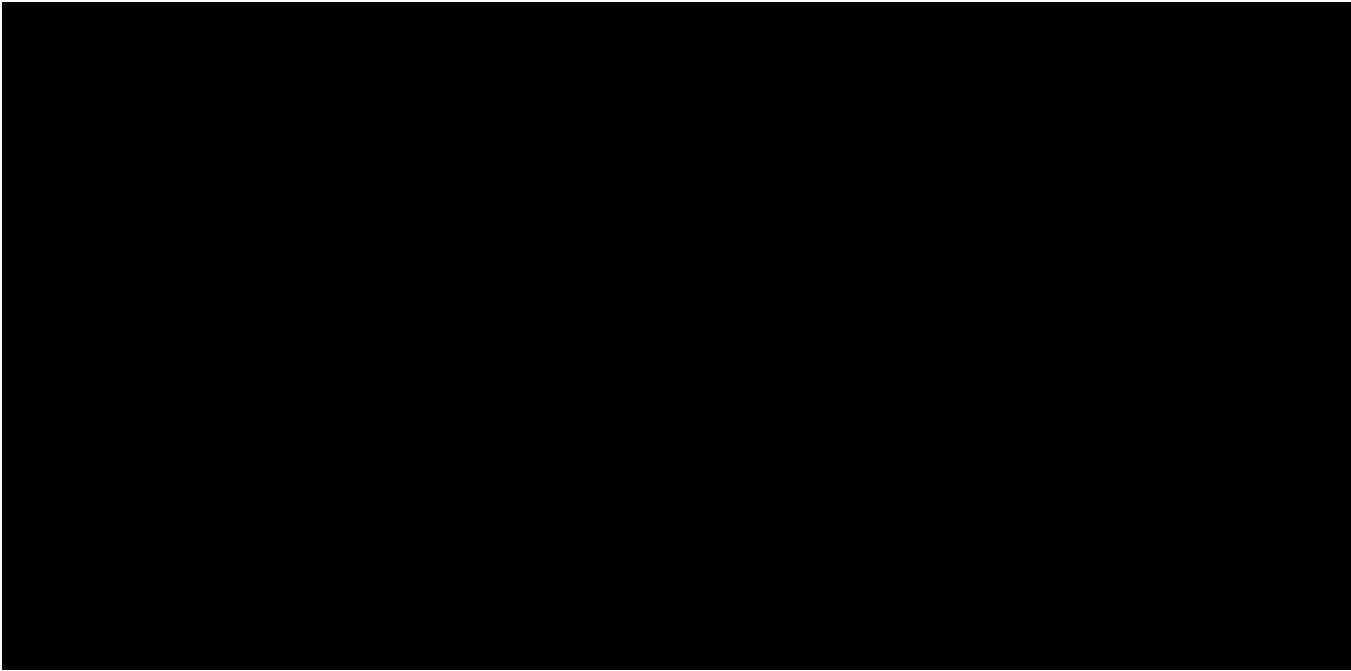
EXECUTIVE COMMITTEE

The parent companies have established an Executive Committee within Vineyard Wind to bring together management expertise from both organizations in order to make key decisions regarding strategy and direct the execution of tactical decisions by Vineyard Wind.

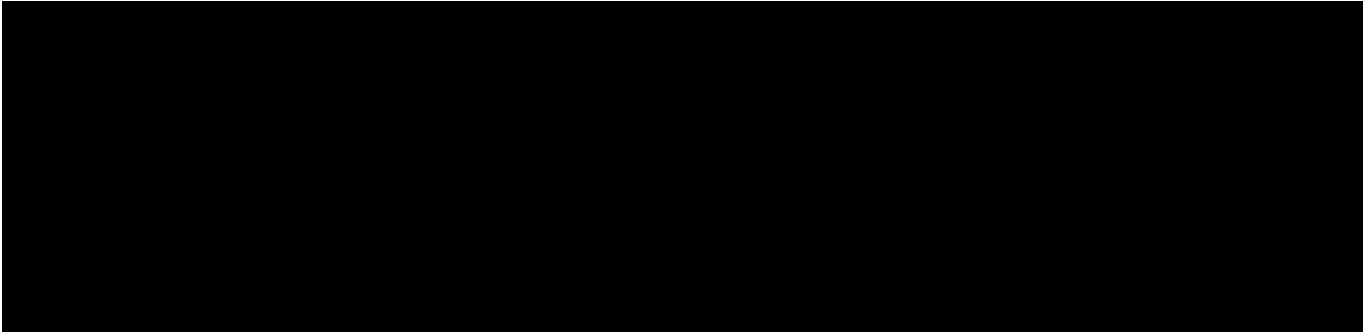




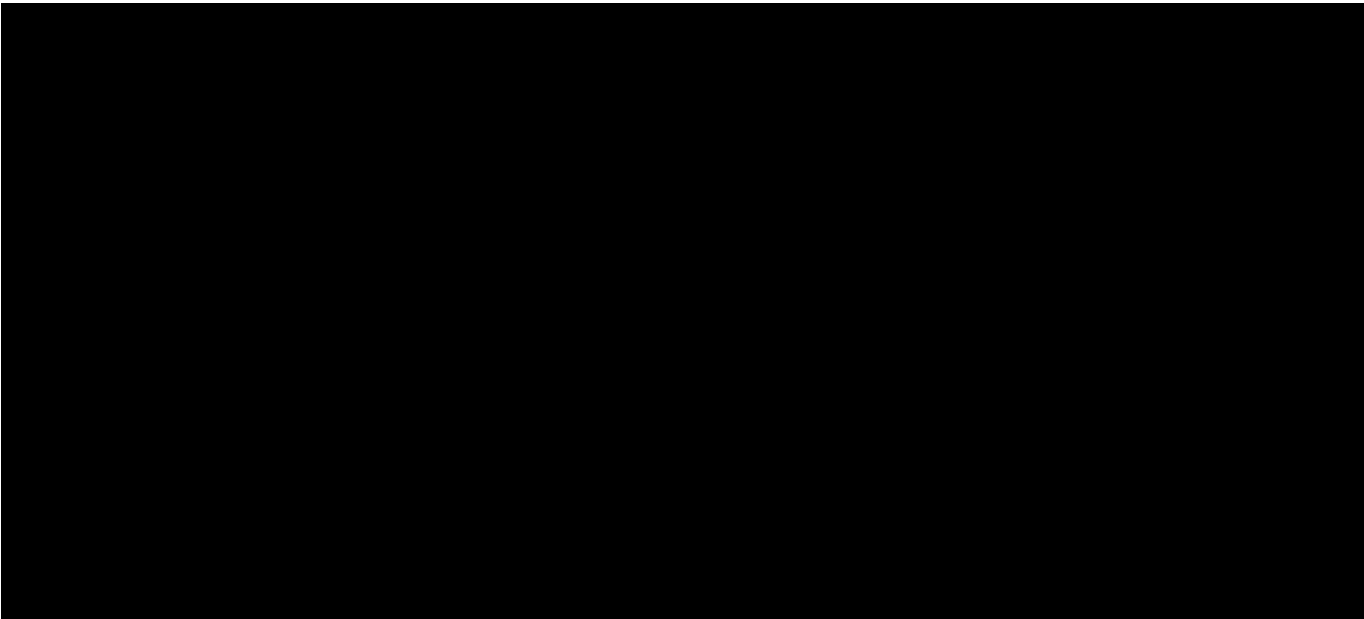


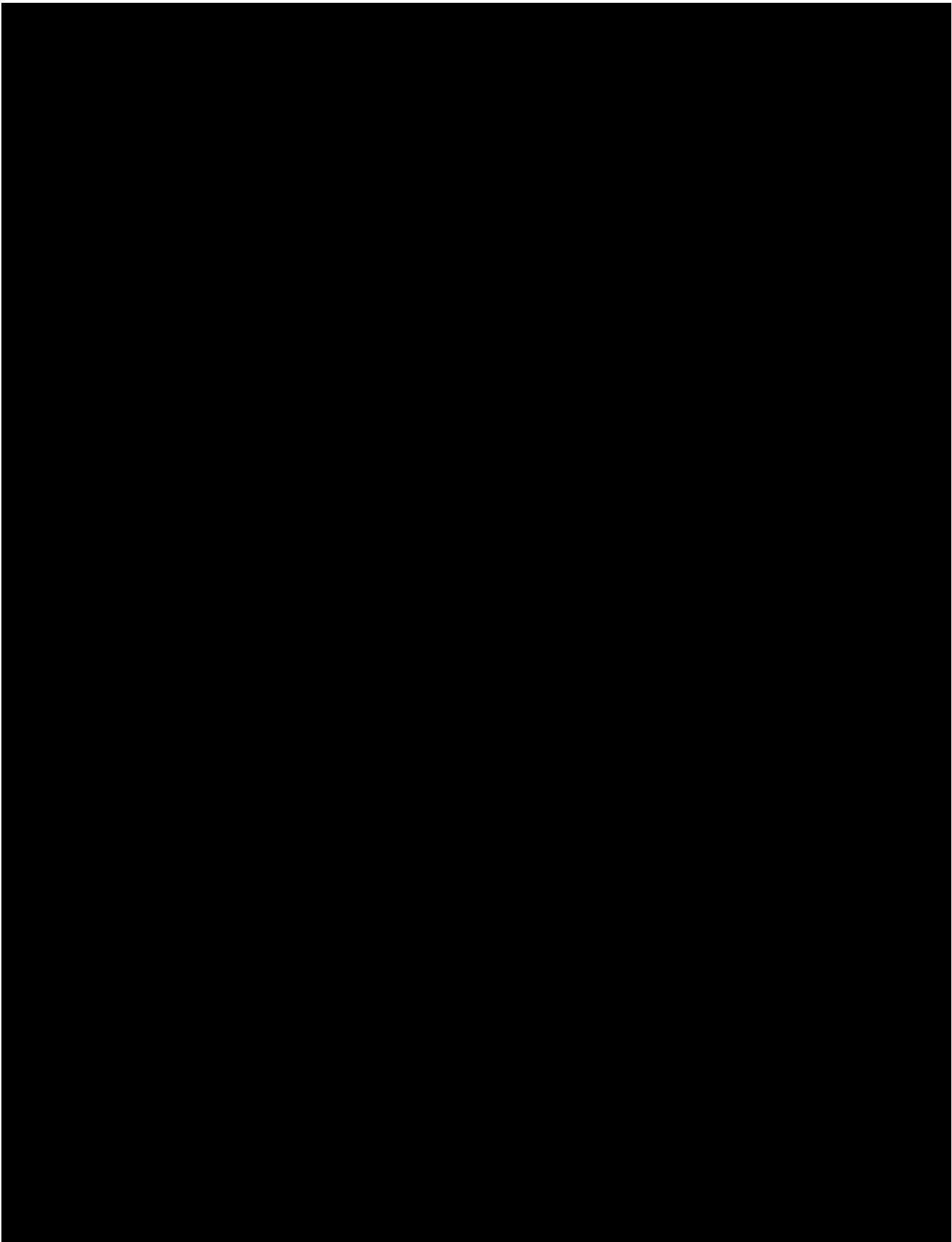


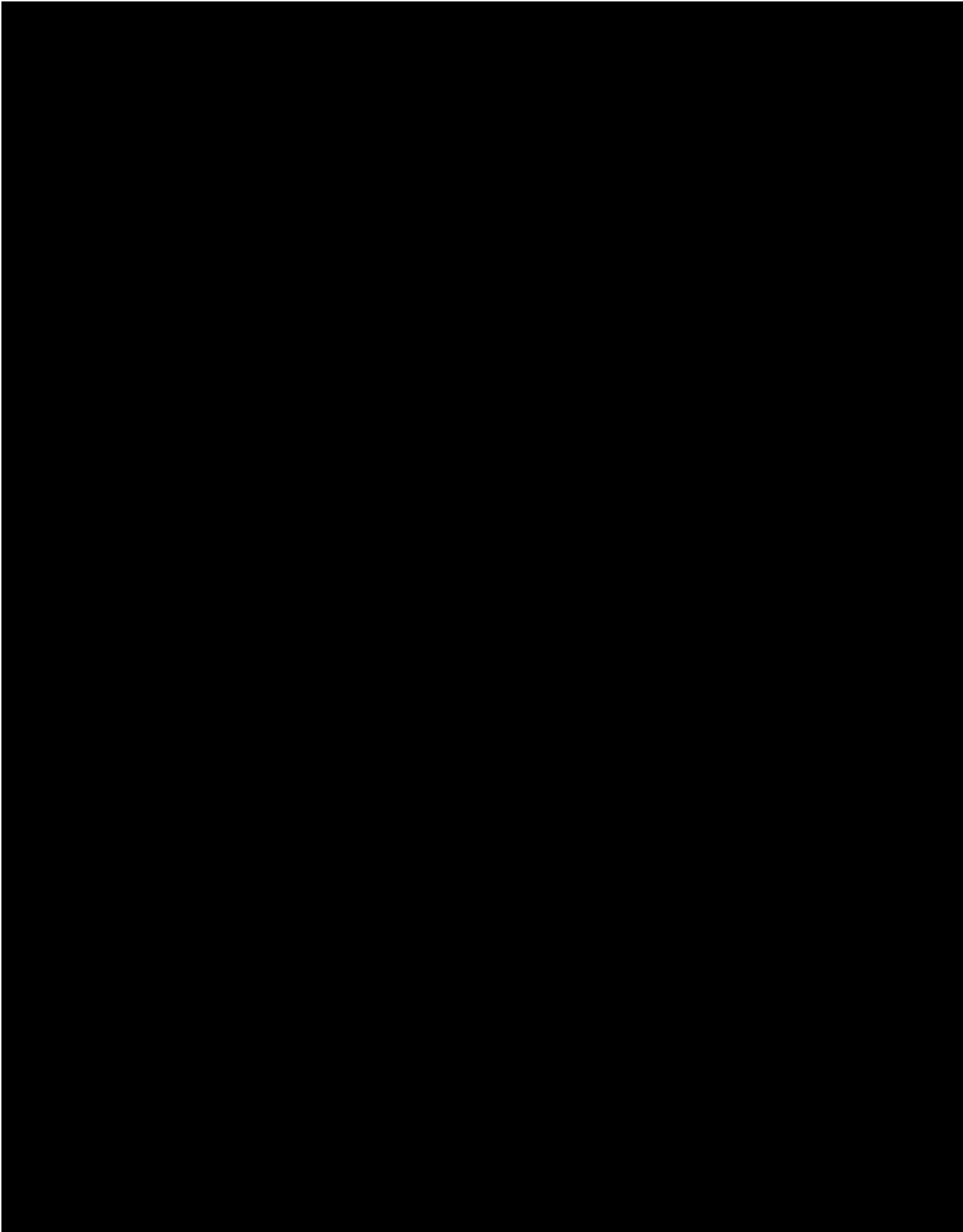
VINEYARD WIND KEY PERSONNEL

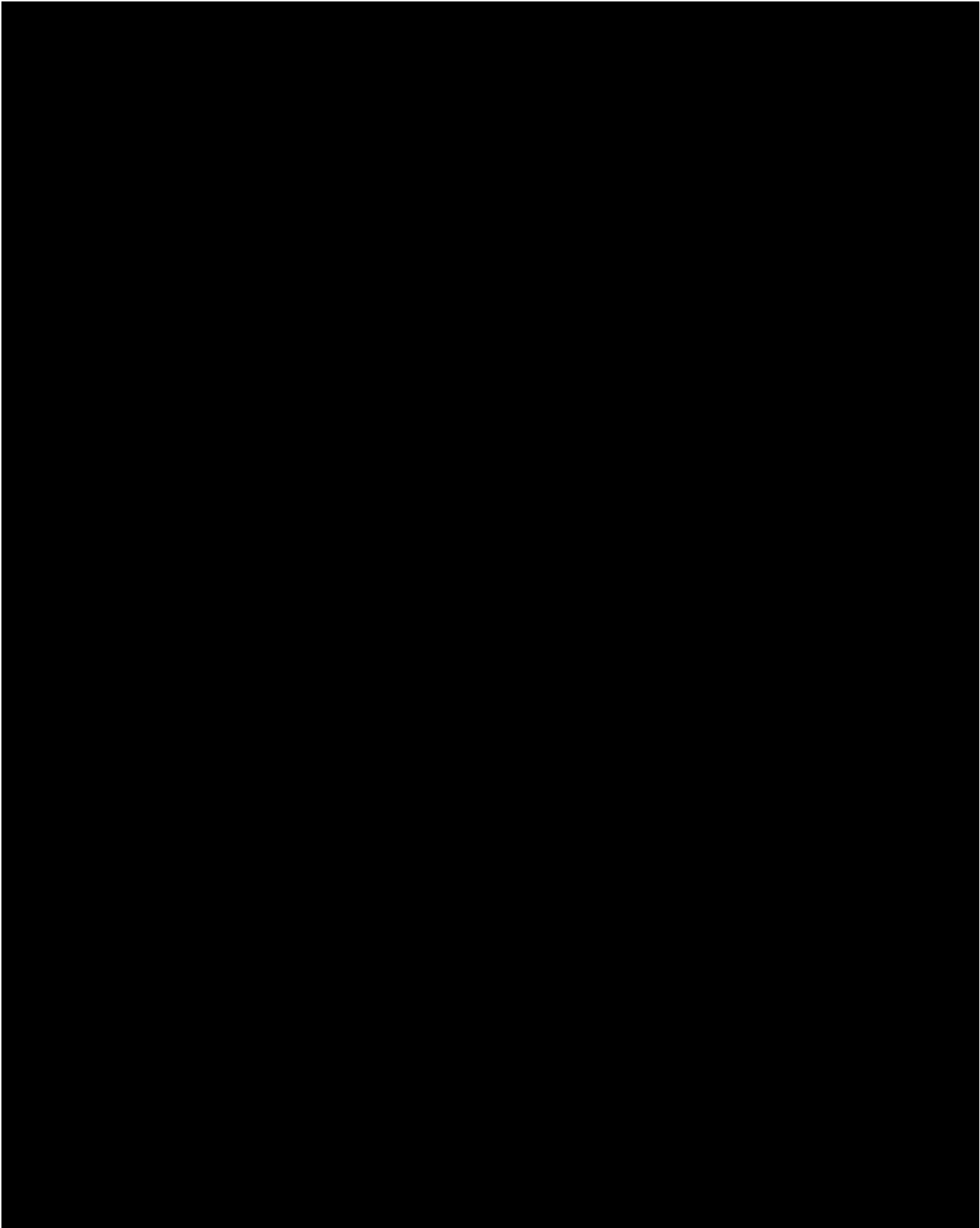


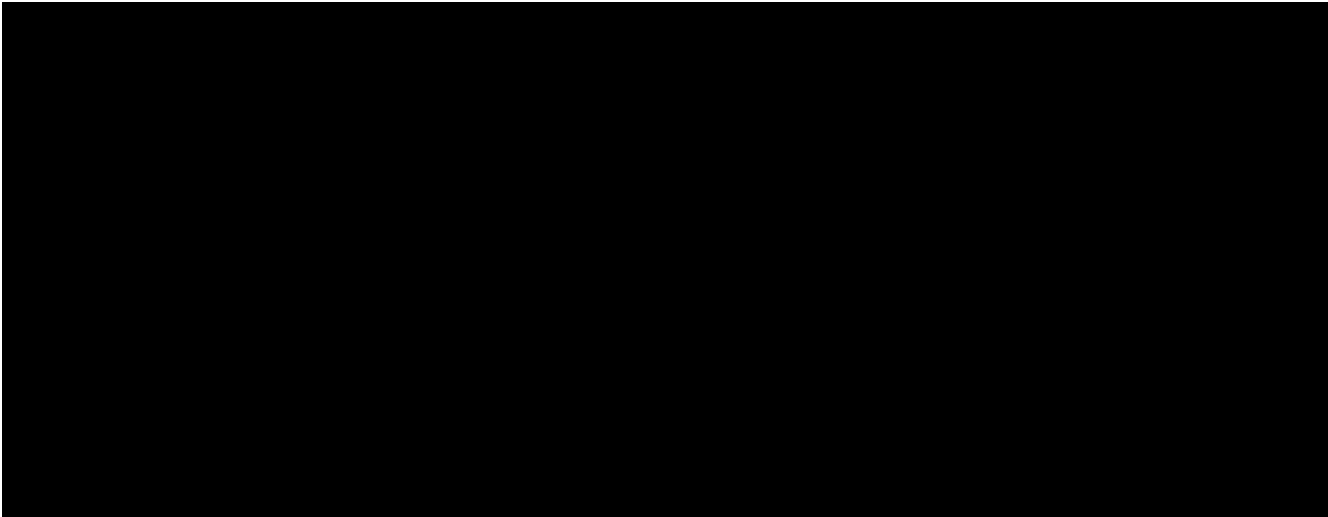
VINEYARD WIND EXECUTION PERSONNEL



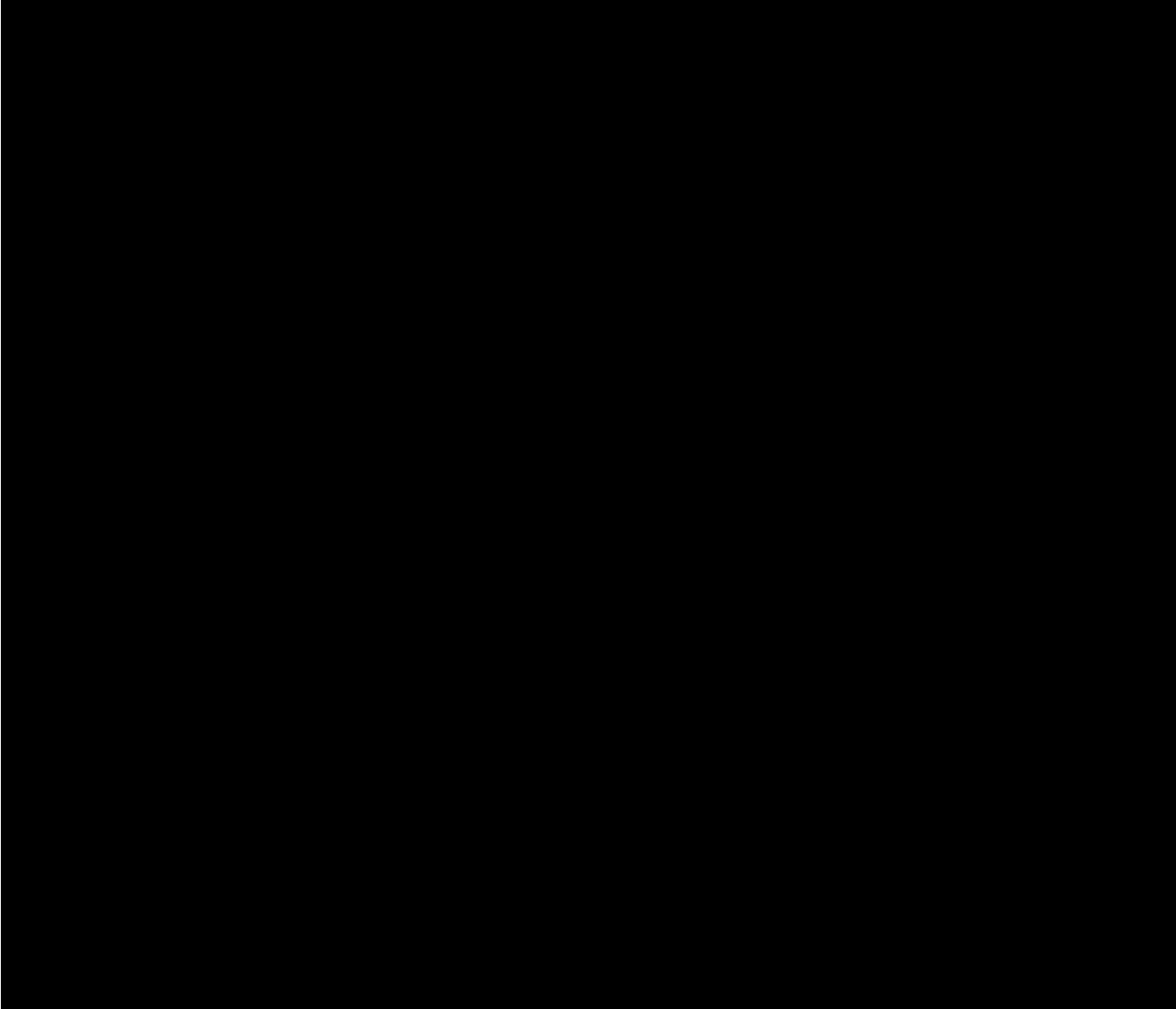






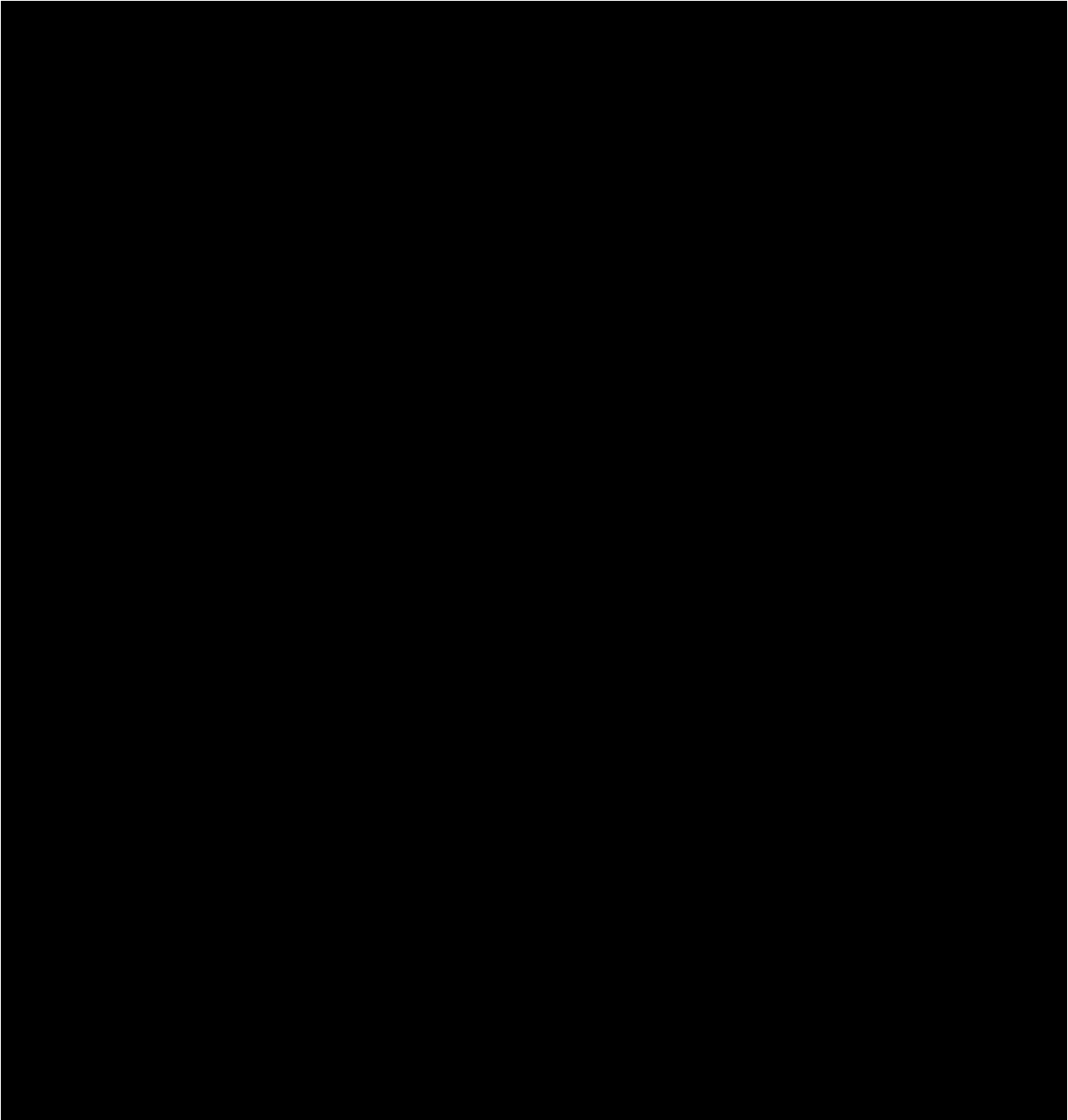


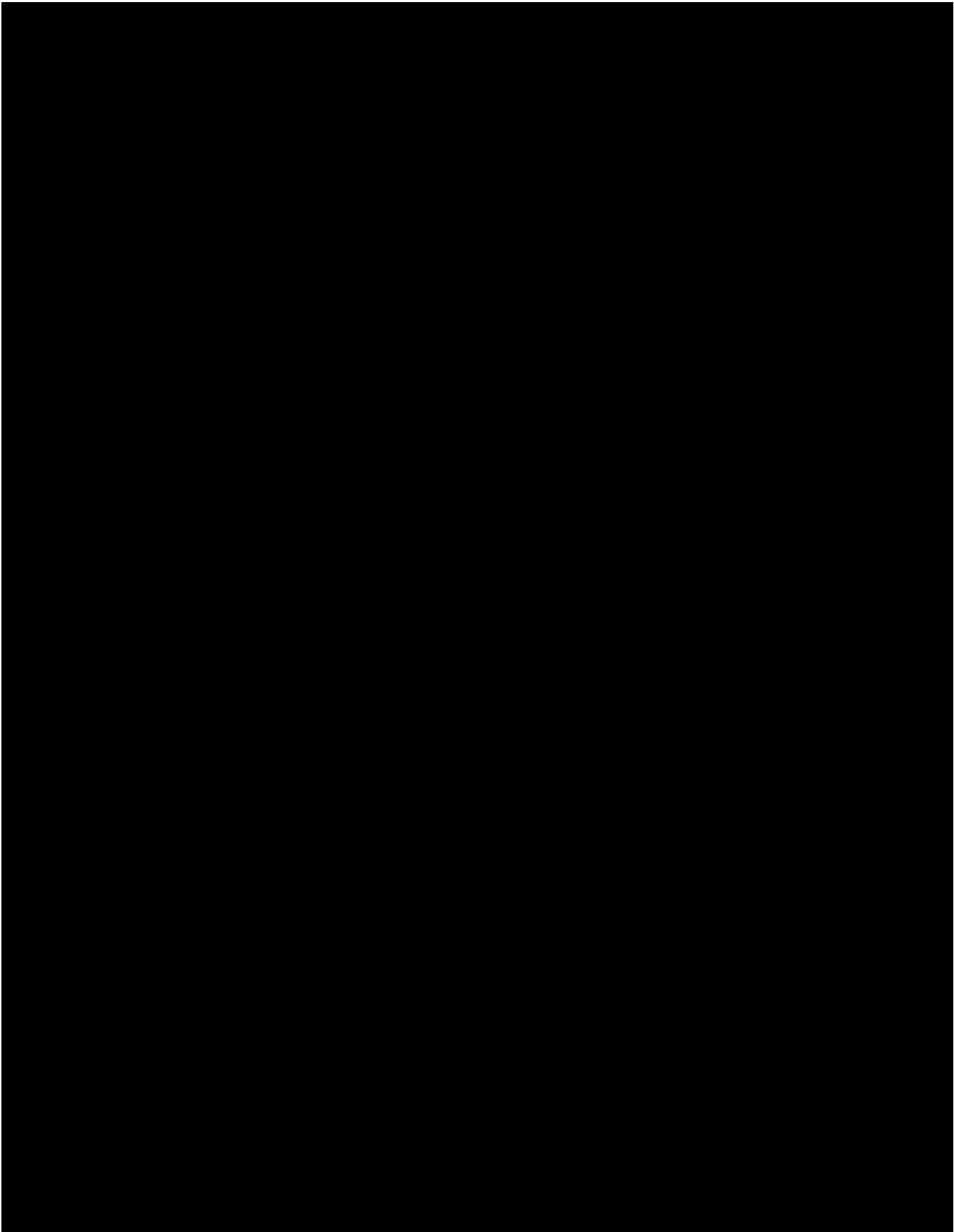
VINEYARD WIND LLC DEVELOPMENT PERSONNEL

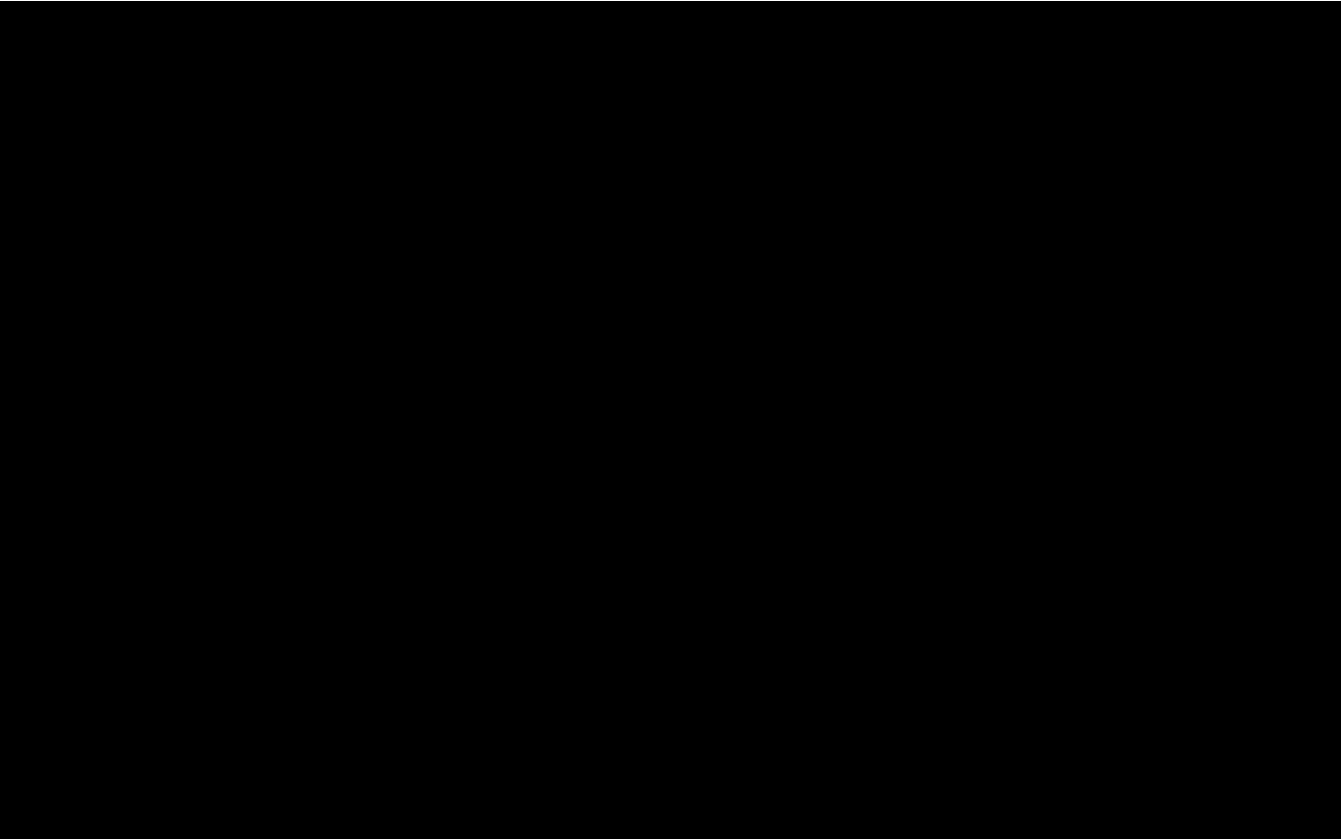


ANBARIC DEVELOPMENT PARTNERS TEAM

ADP's management team brings together a diverse and complementary set of backgrounds and experience, which means the company is well-positioned to successfully build transmission systems on Long Island. The team has expertise in finance, policy, offshore energy engineering and project management, energy marketing and trading, and wholesale electricity market legal and regulatory matters.







-
4. *A listing of projects the Project sponsor has successfully developed or that are currently under construction. Provide the following information for each project as part of the response:*
- a) Name of the project*
 - b) Location of the project*
 - c) Project type, size and technology*
 - d) Commercial Operation Date*
 - e) Estimated and actual capacity factor of the project for the past three years*
 - f) Availability factor of the project for the past three years*
 - g) References, including the names and current addresses and telephone numbers of individuals to contact for each reference.*
-

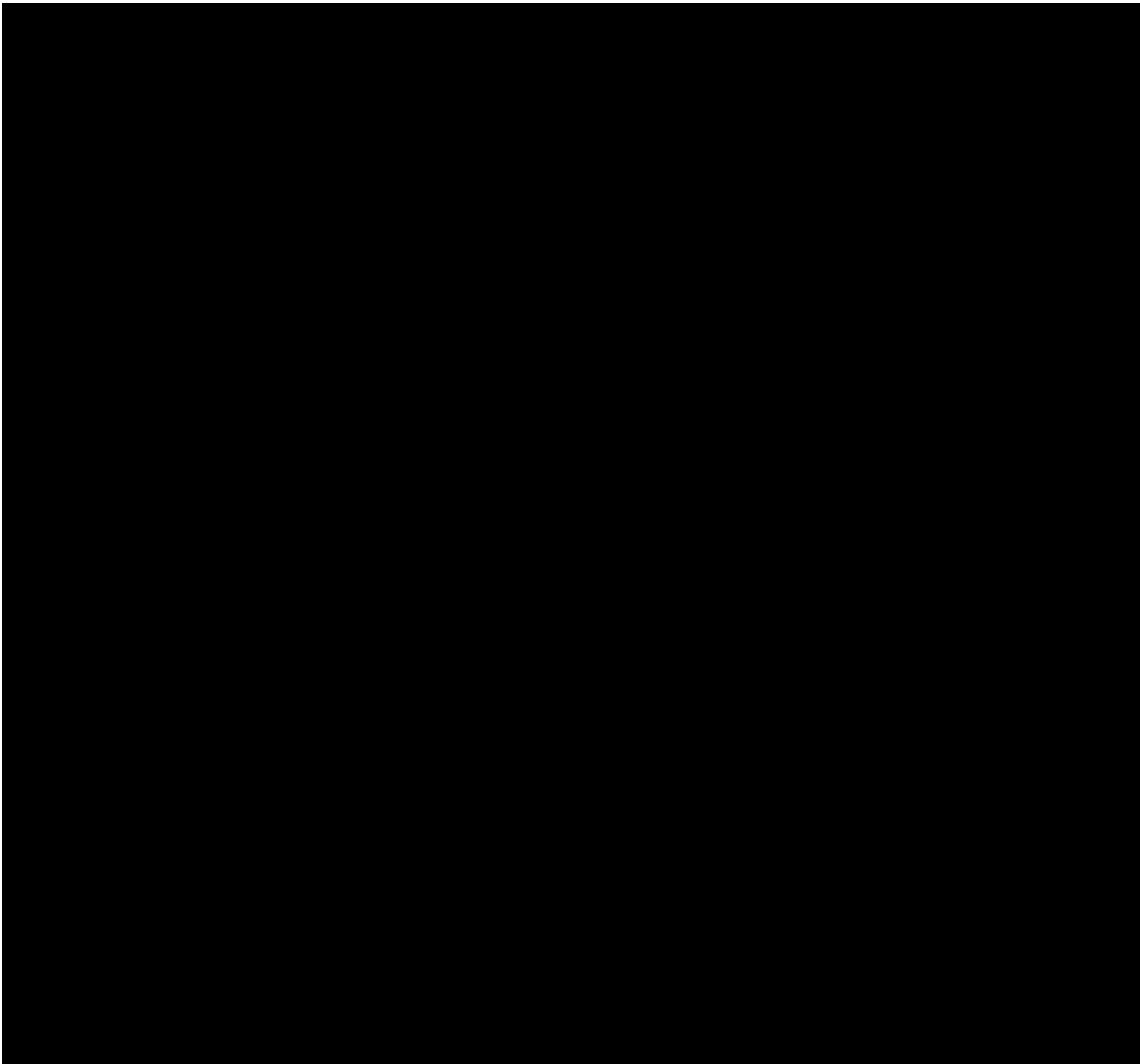
Projects listed in **Tables 2.4-1 and 2.4-2** below include NYISO land-based projects in operation or under construction for Avangrid Renewables as well as offshore generation and offshore transmission projects operating, in pre-construction, or in construction for ScottishPower Renewables, CIP, and Anbaric's development companies. The remainder of the 6,500 MW of Avangrid Renewables' operating onshore projects are provided in **Attachment 2.4-1**.

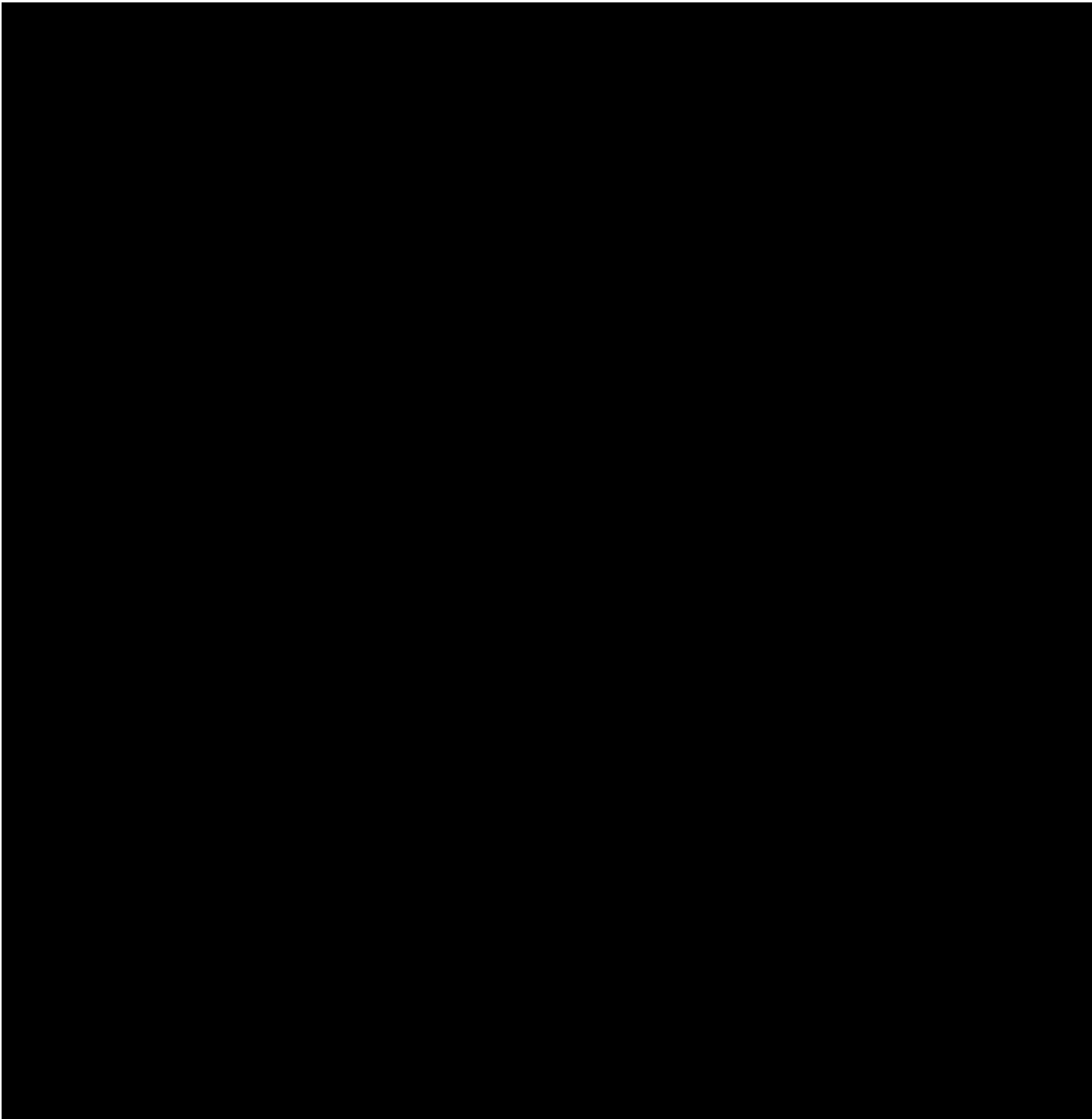
REFERENCES

Vineyard Wind is providing the following client references from the parent companies' similar wind energy projects that have been developed, executed, and are currently in operation. Additional references will be provided upon request.

Avangrid Renewables

Project Names: Maple Ridge I, II & Hardscrabble
Doreen Harris
NYSERDA
17 Columbia Circle
Albany, NY 12203





5. *With regard to Proposer's Project team, identify and describe the entity responsible for the following, as applicable:*
- a) *Construction Period Lender, if any*
 - b) *Operating Period Lender and/or Tax Equity Provider, as applicable*
 - c) *Financial Advisor*
 - d) *Environmental Consultant*
 - e) *Facility Operator and Manager*
 - f) *Owner's Engineer g. EPC Contractor (if selected)*
 - g) *Transmission Consultant*
 - h) *Legal Counsel*

Most of the entities described in the following section are engaged after the execution of a Power Purchase Agreement (PPA), or similar, when the economics and obligations of the Project are settled. Vineyard Wind and the parent companies have extensive contacts and access to all of the firms required to satisfy the financing, environmental assessment, operation, engineering, transmission,

[REDACTED]

- i. **Construction Period Lender** - [REDACTED]
[REDACTED]
[REDACTED]
- ii. **Operating Period Lender and/or Tax Equity Provider** - If relevant, this will be finalized at the appropriate phase of the Project's development.
- iii. **Financial Advisor** -Vineyard Wind will appoint a financial advisor in the period following award of an OREC P&SA, [REDACTED]
[REDACTED]
[REDACTED]
- iv. **Environmental Consultant** - [REDACTED]
[REDACTED]
[REDACTED]
[REDACTED]
- v. **Facility Operator and Manager** - [REDACTED]
[REDACTED]
[REDACTED]
- vi. **Owners' Engineer** [REDACTED]
[REDACTED]
- vii. **EPC Contractor** - [REDACTED]
[REDACTED]

[Redacted]

viii. **Transmission Consultant –**

[Redacted]

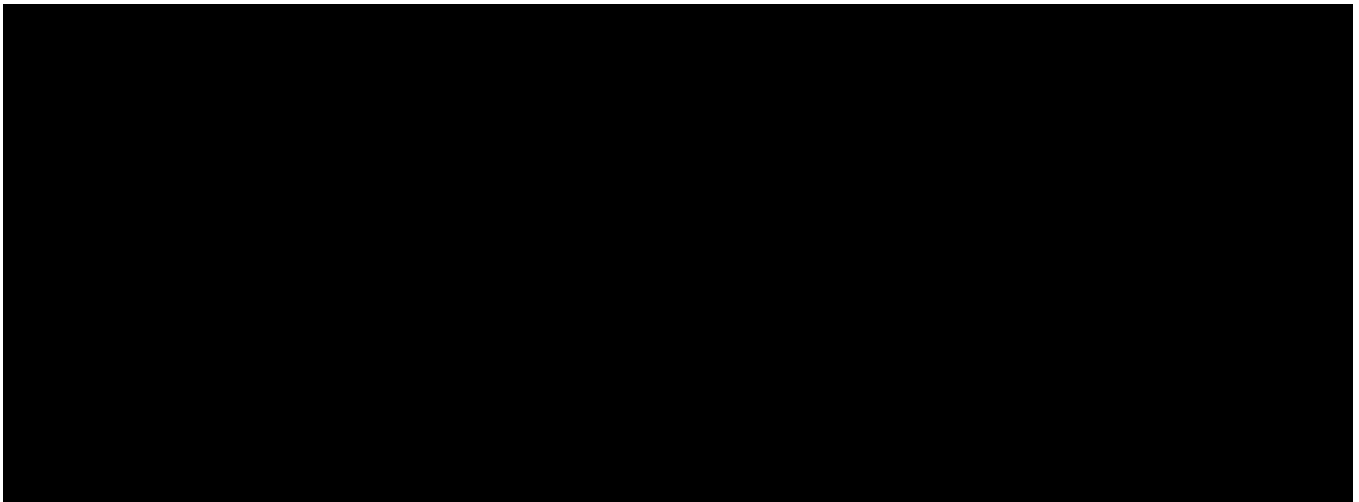
ix. **Legal Counsel –**

[Redacted]

6. *Details of Proposer's experience in NYISO markets. With regard to Proposer's experience with NYISO markets, please indicate the entity that will assume the duties of Market Participant for your proposed Offshore Wind Generating Facility. Please provide a summary of Proposer's or Market Participant's experience with the wholesale market administered by NYISO as well as transmission services performed by Con Edison, NYPA, and PSEG-LI/LIPA.*

LEAD MARKET PARTICIPANT

[Redacted]





LIBERTY WIND

SECTION 3 - PROJECT DESCRIPTION AND SITE CONTROL

Proposal for New York State Energy Research and Development Authority in response to Request For Proposals for Purchase of Offshore Wind Renewable Energy Certificates



Photo: Veja Mate offshore wind farm

SECTION 3 PROJECT DESCRIPTION AND SITE CONTROL

OVERVIEW

[REDACTED]

[REDACTED] This section describes Project Three.

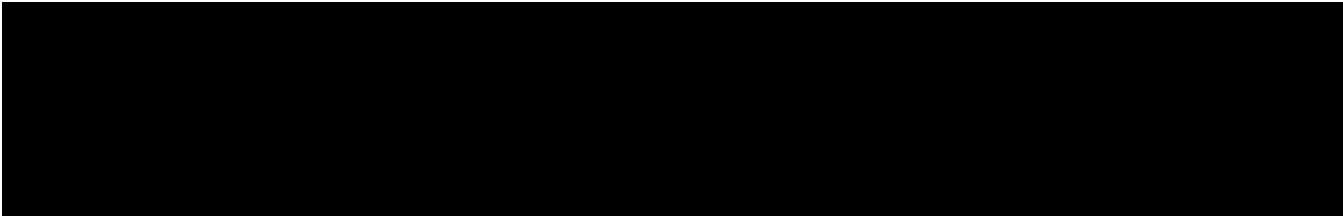
Liberty Wind is an offshore wind project that Vineyard Wind is proposing to build in federally designated Lease Area OCS-A 0522 (the “Lease Area”), which is located approximately 85 miles (mi) east of Montauk, Long Island. The Project will consist of an Offshore Wind Generation Facility and the transmission required for a direct interconnection to the New York Control Area (NYCA) [REDACTED]

[REDACTED]

[REDACTED]

3.1 Identify the BOEM wind energy area where the proposed Offshore Wind Generation Facility will be located. Provide documentation that Proposer has a valid lease or irrevocable lease option to develop the leased area within this wind energy area over the entire Contract Tenor.


Liberty Wind’s Offshore Wind Generation Facility will be located in Lease Area OCS-A 0522, which is located approximately 85 mi east of Long Island. Vineyard Wind is the designated provisional winner of the Lease Area having successfully bid into the US Department of Interior (DOI), Bureau of Ocean Energy Management’s (BOEM) offshore wind auction held on December 13-14, 2018. The lease agreement for Lease Area OCS-A 0522 is for the purpose of offshore wind energy generation on the Outer Continental Shelf.





A copy of the US DOI press release announcing final bid results with Vineyard Wind as the final, highest bidder and the provisional winner of the Lease Area is provided as **Attachment 3.1-1**; the draft commercial lease agreement for OCS-A 0522 is provided as **Attachment 3.1-2**; the executed lease for Lease Area OCS-A 0501 is provided as **Attachment 3.1-3**; and a letter of good standing from BOEM, concerning our lease for Lease Area OCS-A 0501, is provided as **Attachment 3.1-4**.

3.2 Provide a site plan (or plans) including a map (or maps) that clearly identifies the location of the proposed Offshore Wind Generation Facility, collection facilities, offshore and onshore route of the generator lead line to the interconnection point, converter station(s), and the assumed right-of-way width. Identify the anticipated interconnection point, support facilities, and the relationship of the interconnection point to other local infrastructure, including transmission facilities, roadways, and waterways.

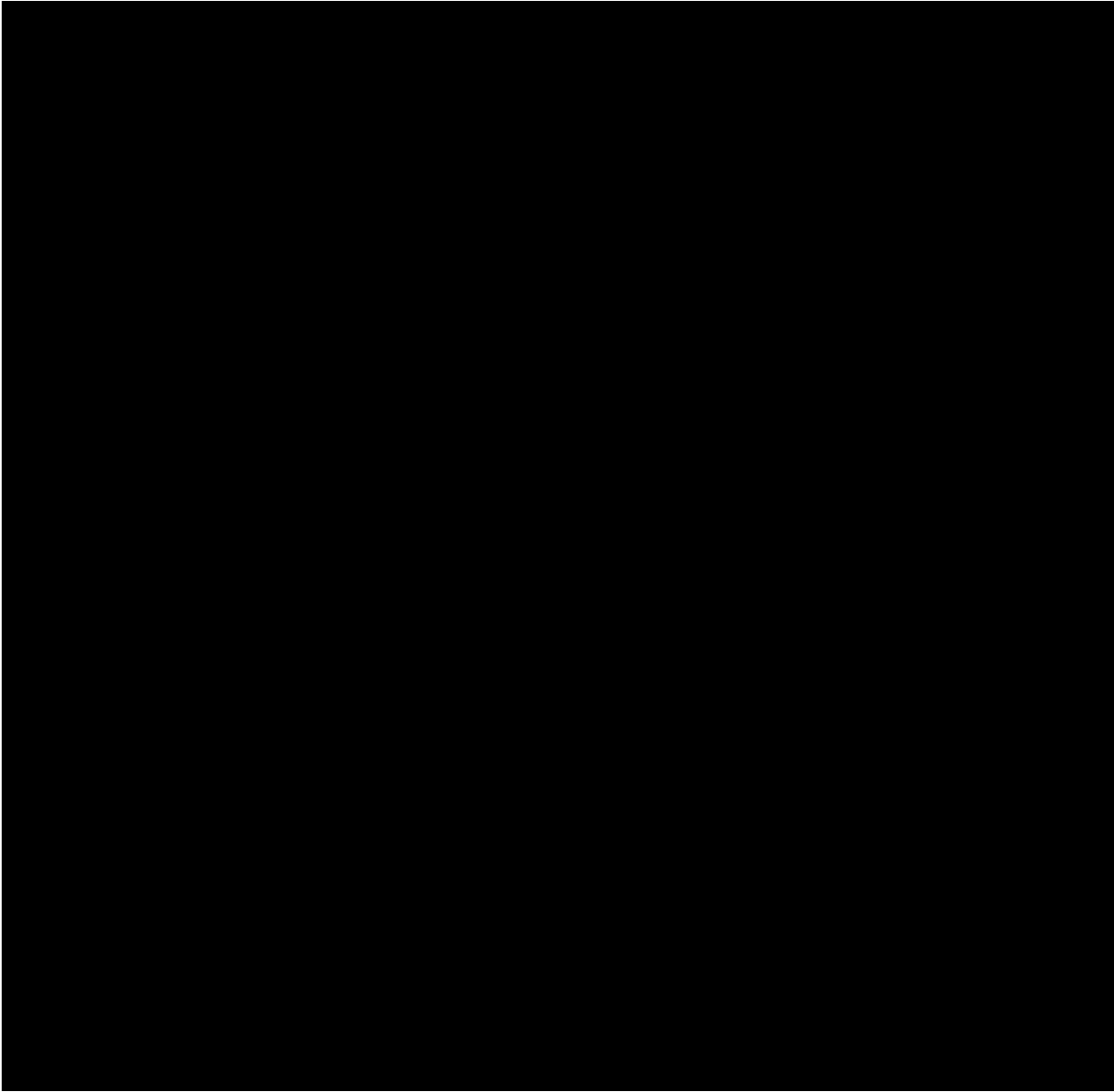
OFFSHORE WIND GENERATION FACILITY SITE

Liberty Wind is an offshore wind project that consists of an Offshore Wind Generation Facility and the transmission required for a direct interconnection 

 For the purposes of this section, the Offshore Wind Generation Facility site comprises the area where the Offshore Wind Generation Facility will be located, namely Lease Area OCS-A 0522.

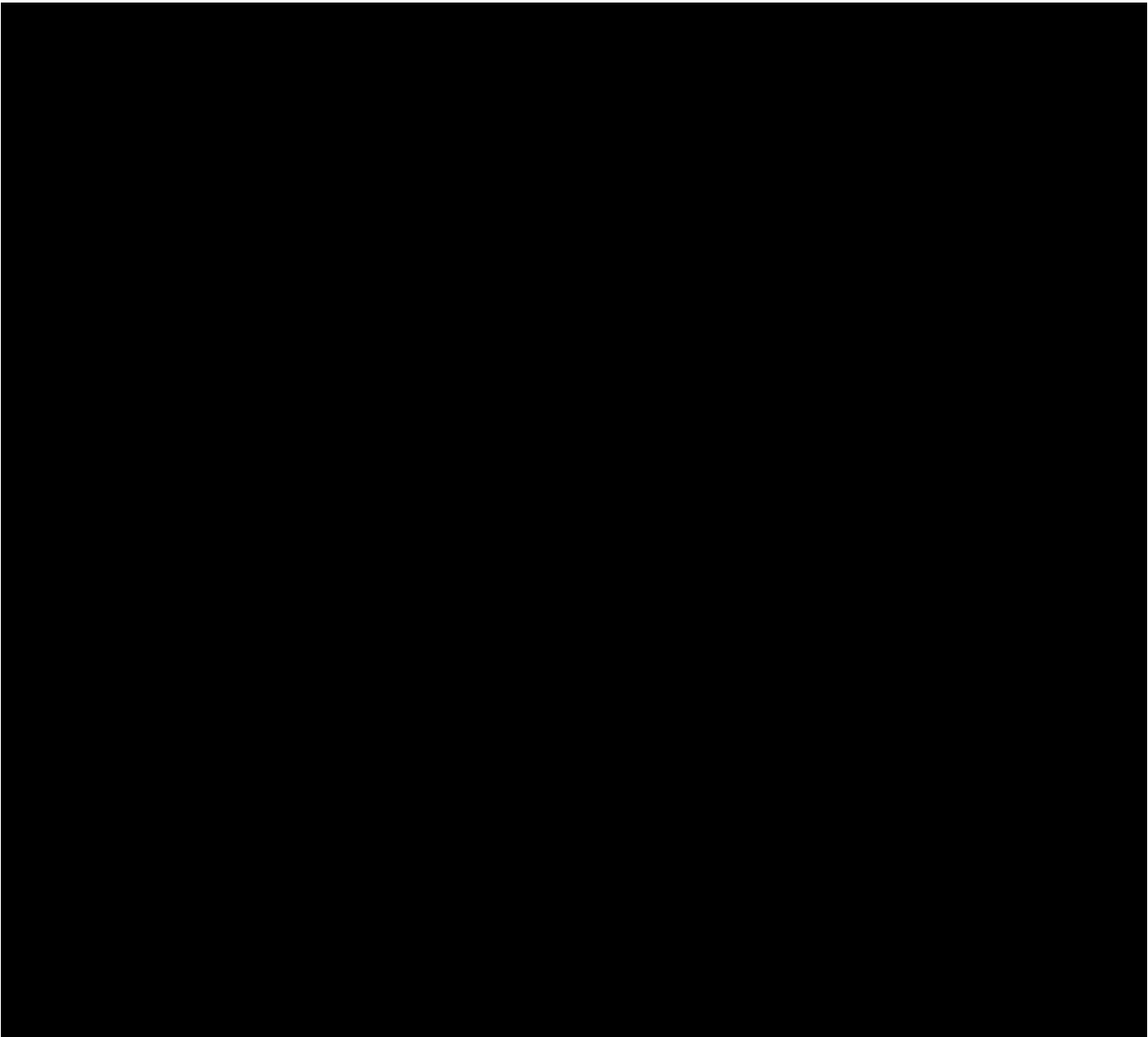
The Offshore Wind Generation Facility site is located approximately 85 mi (72 nautical miles [nm]) east of Montauk, Long Island in Lease Area OCS-A 0522. Lease Area OCS-A 0522 is a 207 square mile (sq. mi) area located in federal waters in the Atlantic Ocean. 

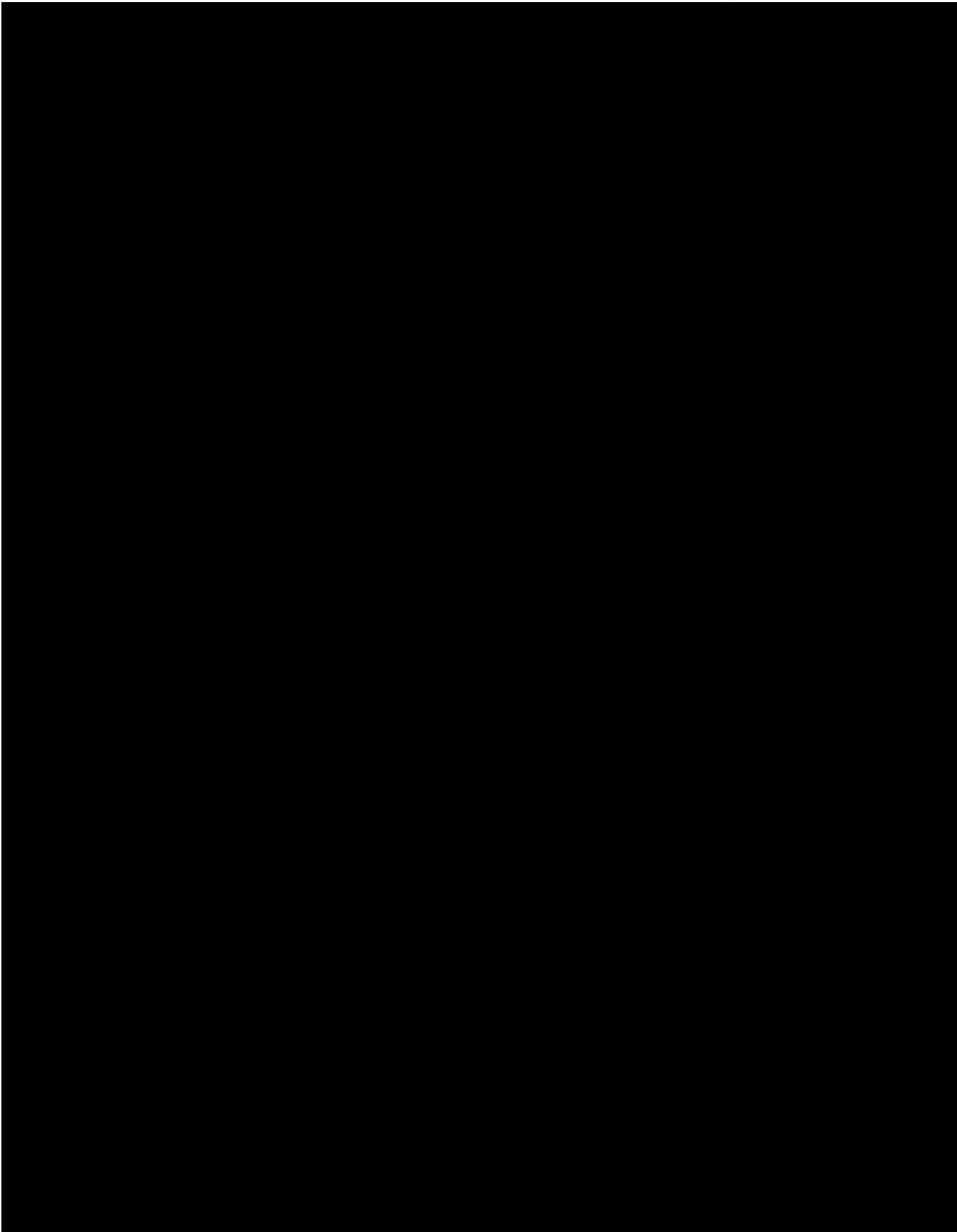




OFFSHORE EXPORT CABLE ROUTE

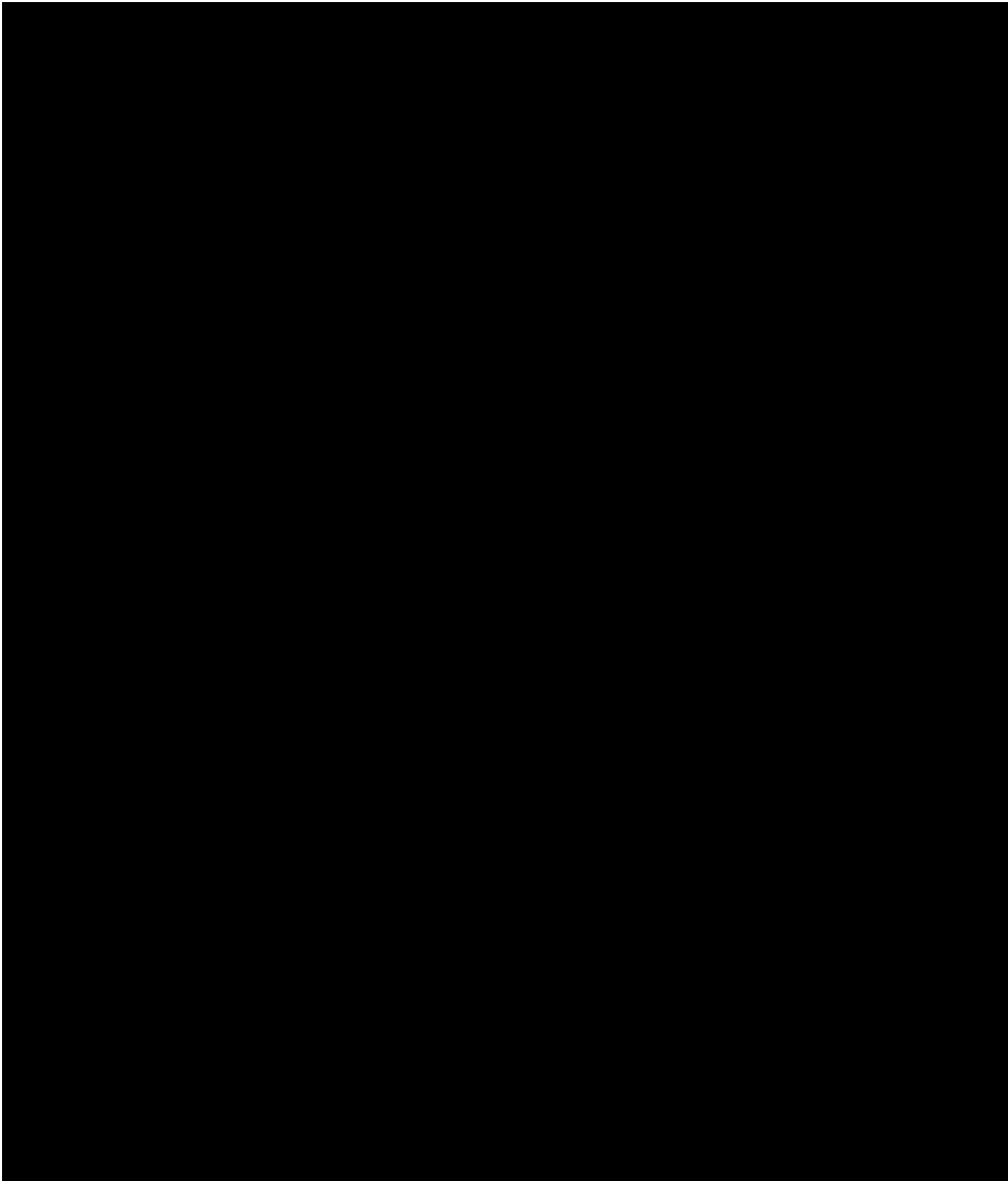




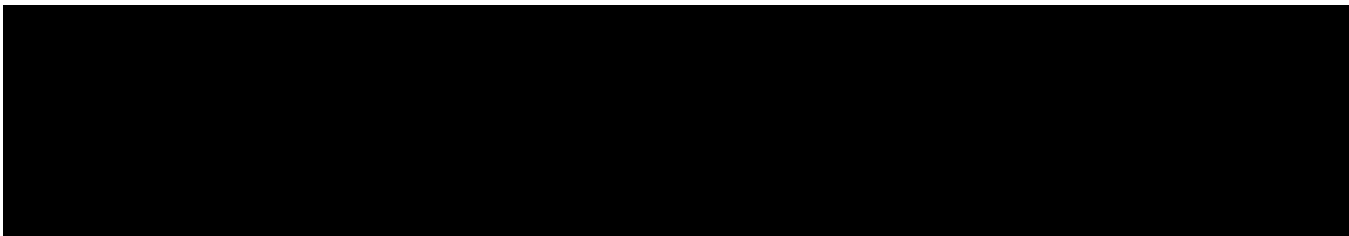




ONSHORE FACILITIES

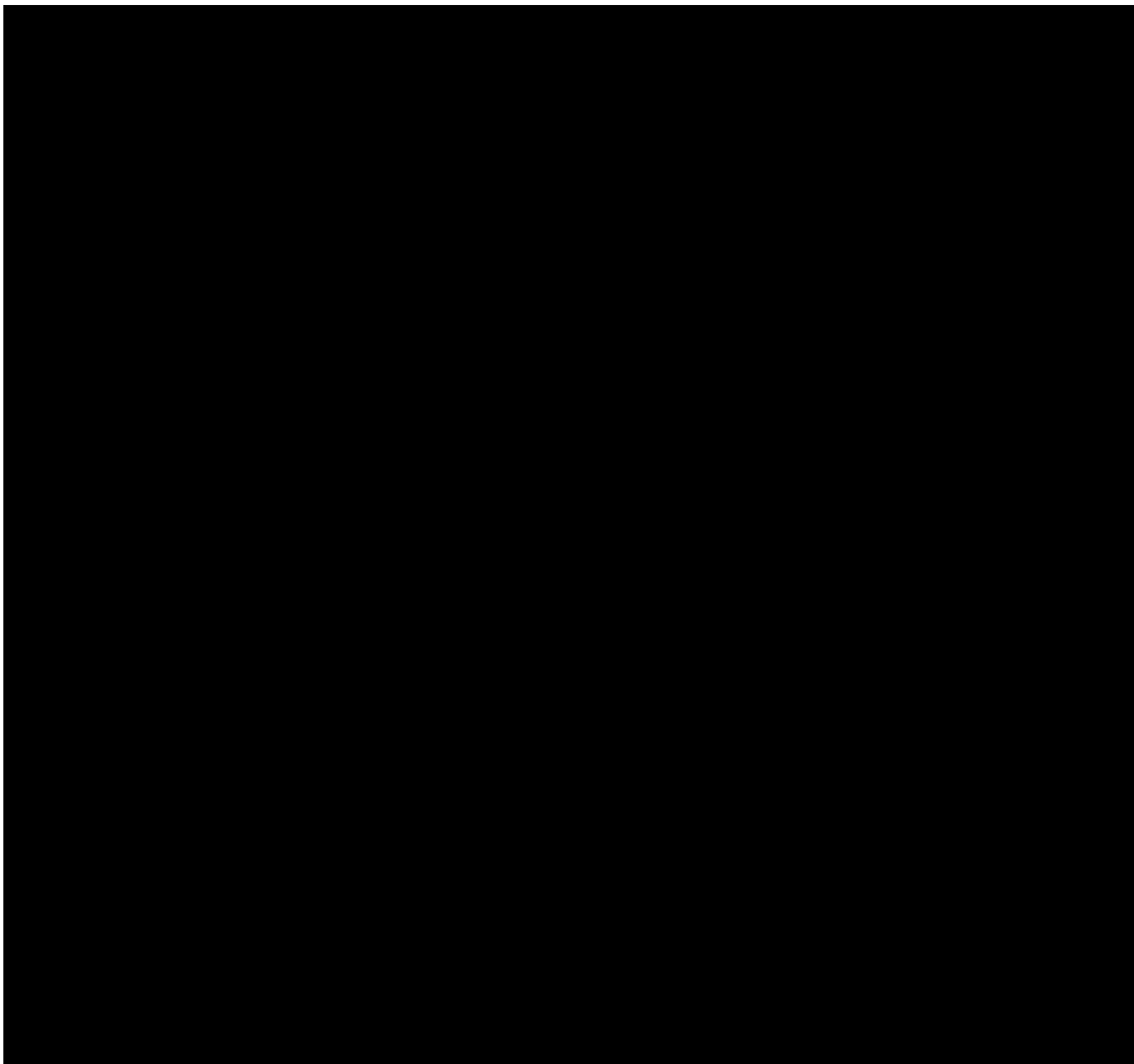


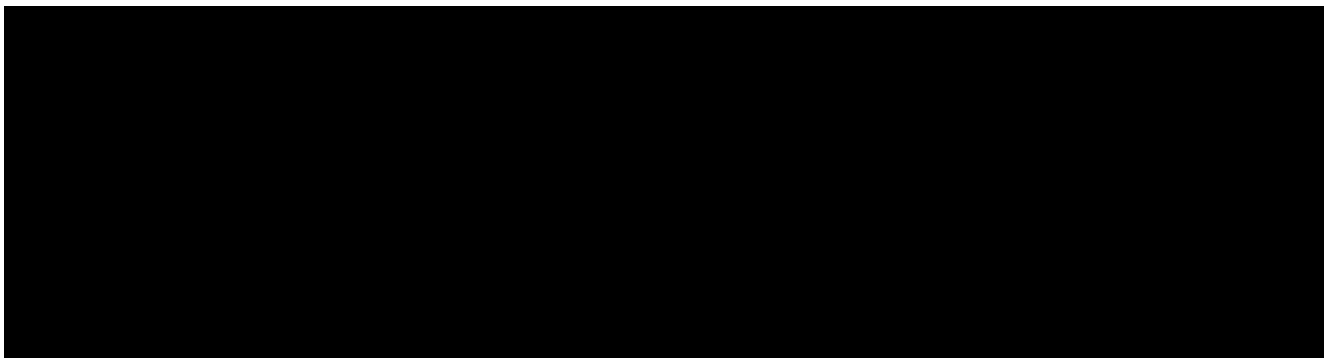
LANDFALL SITE



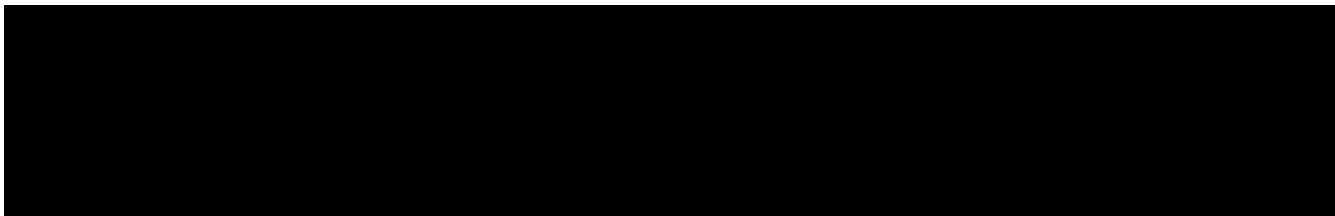
Criteria for Selection of Landfall

Multiple landfall locations were evaluated for the Project. The preliminary evaluation of potential landfall locations focused on sites that met the following criteria:

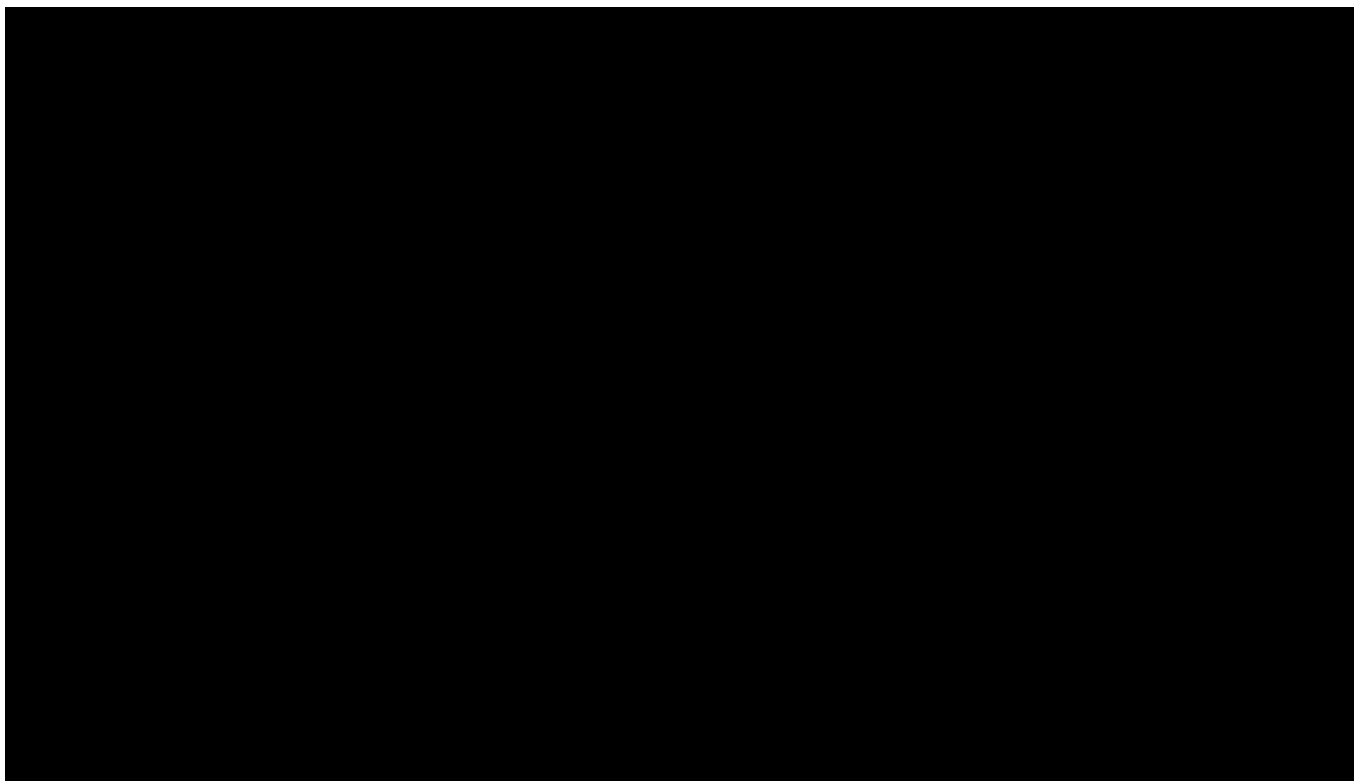




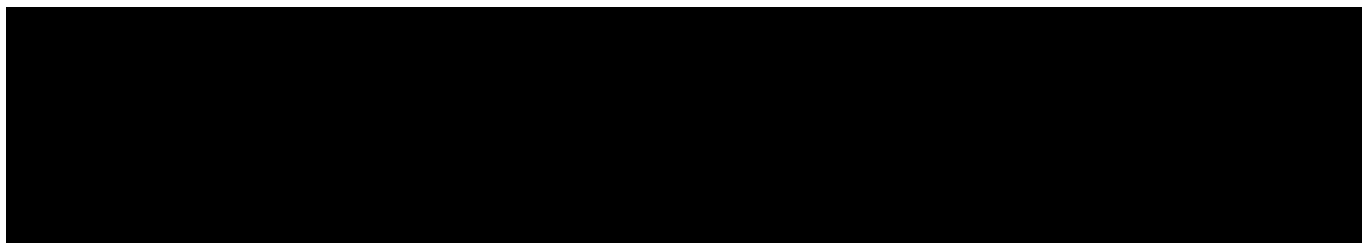
Criteria for Selection of Cable Routes

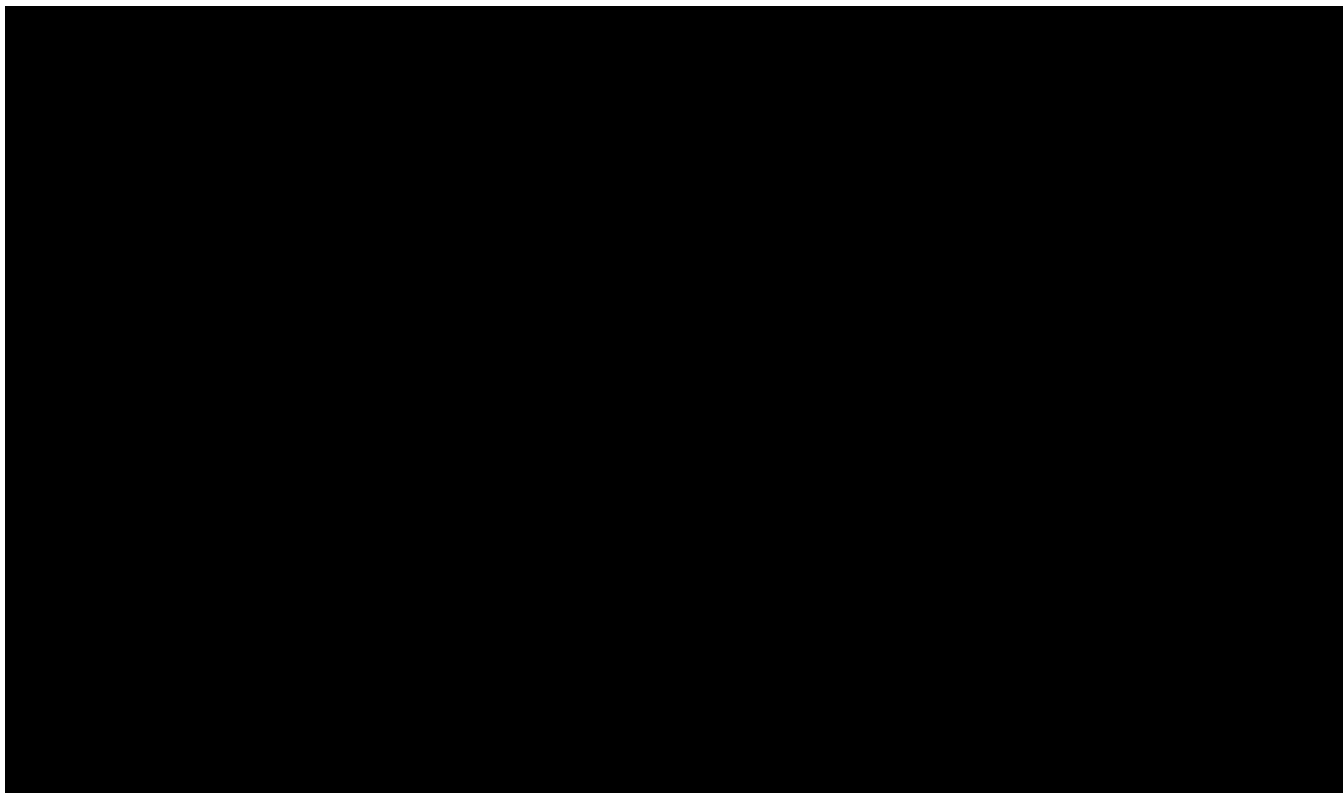


The specific criteria used to determine the onshore export cable route are as follows:

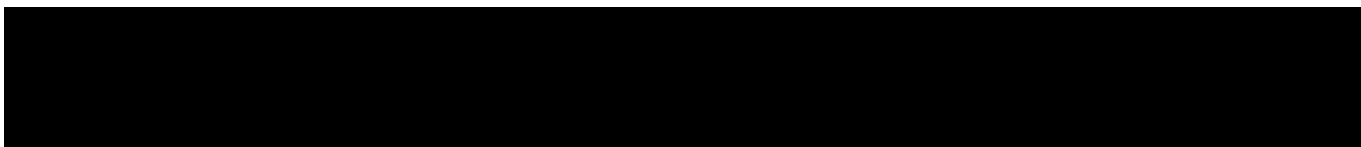


ONSHORE EXPORT CABLE ROUTE



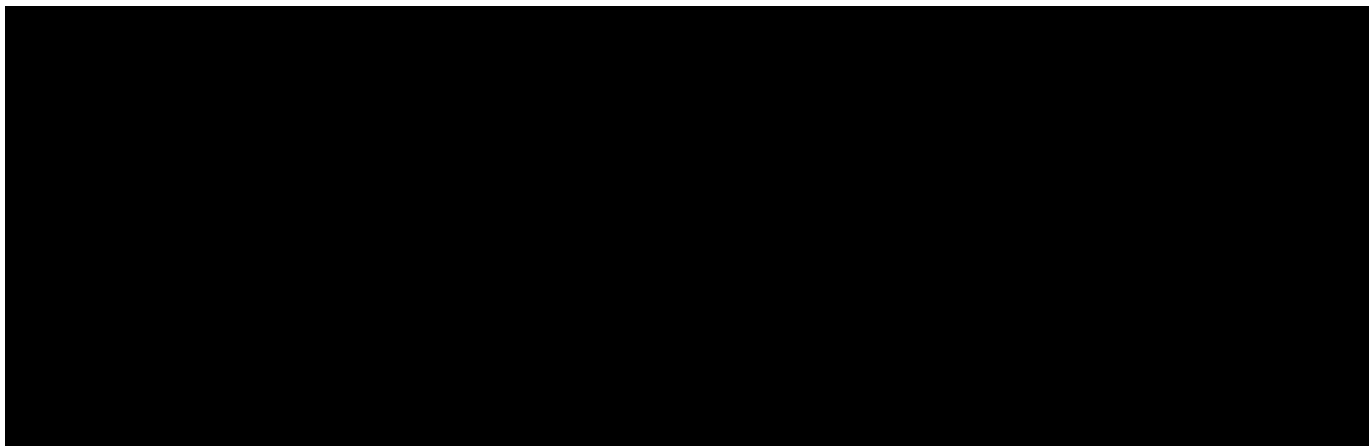


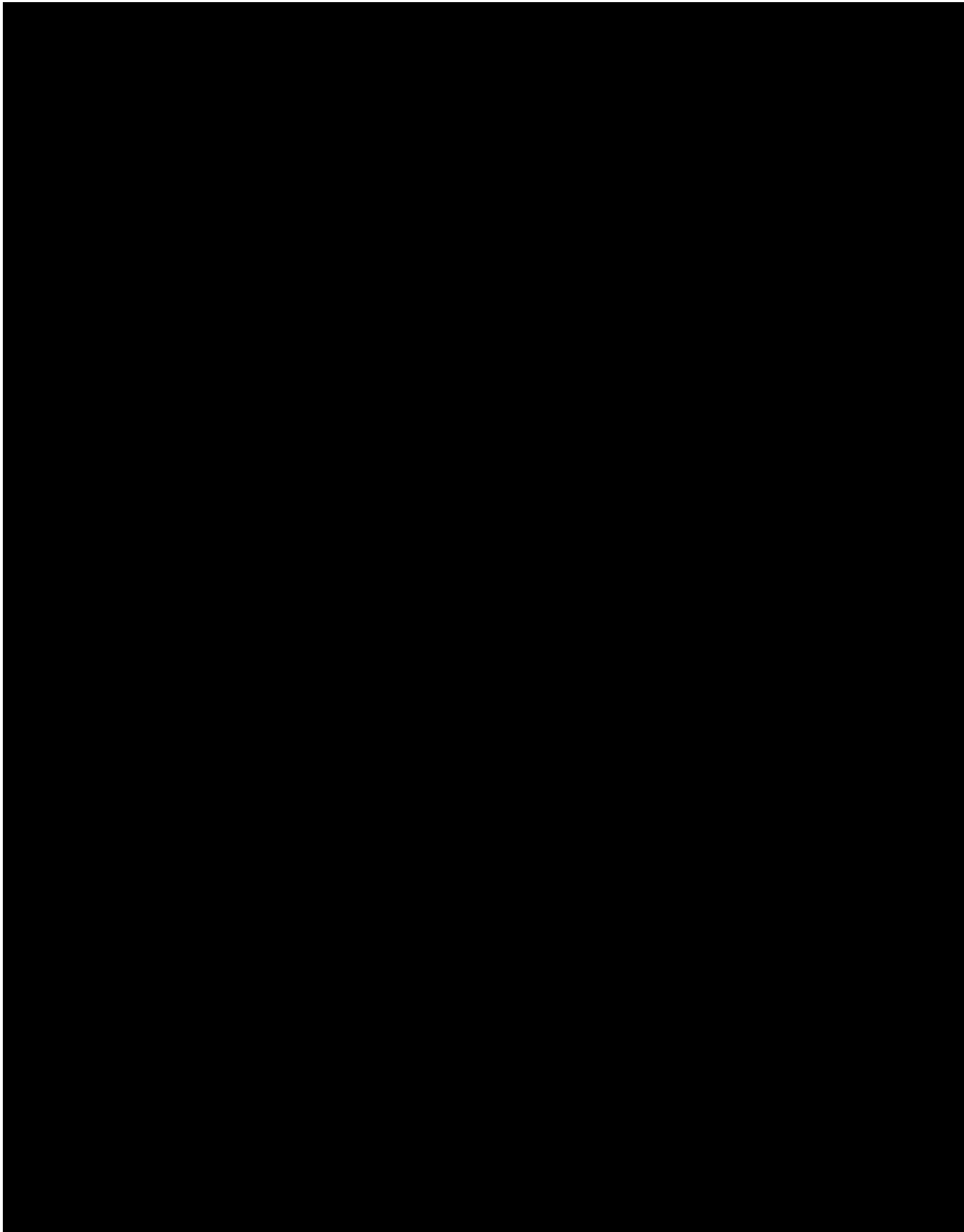
ONSHORE SUBSTATION

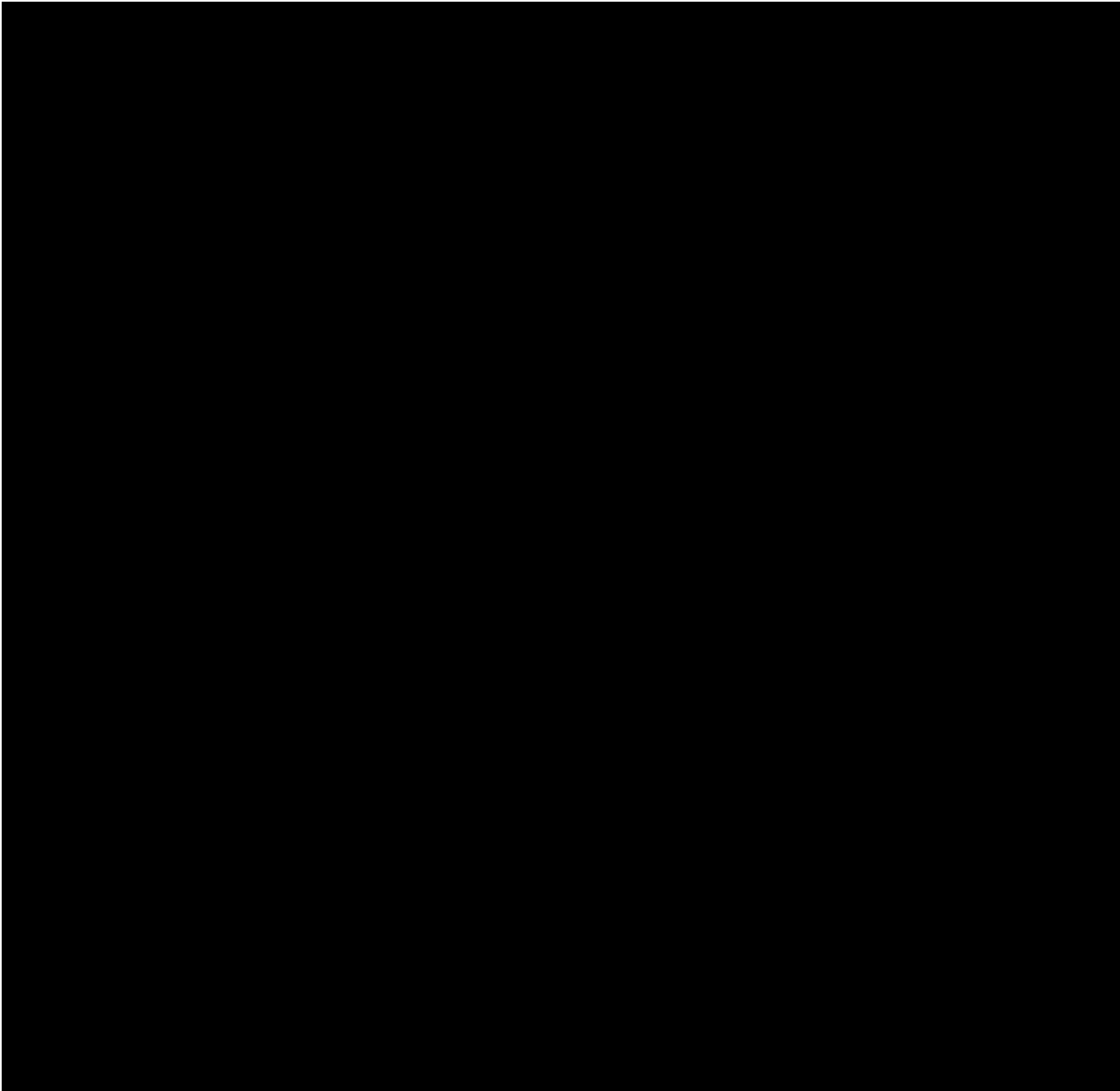


Criteria for Selection of Onshore Substation Location

Potential locations for the onshore substation were identified and evaluated using the following criteria:







3.3 Identify any rights that Proposer or its development partner has at the interconnection point and for the generator lead line right of way. Provide a detailed plan and timeline for the acquisition of any additional rights necessary for interconnection and for the generator lead line right-of-way. Include these plans and the timeline in the overall Project schedule in Section 6.4.10.

SITE CONTROL

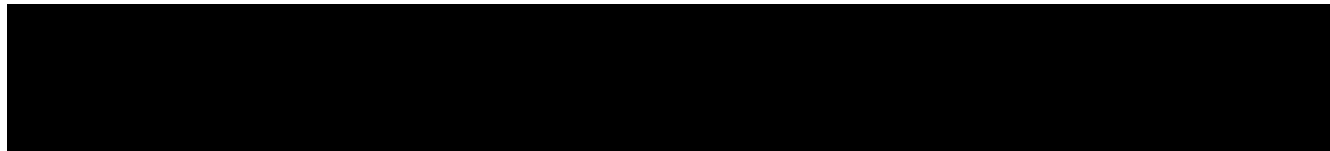
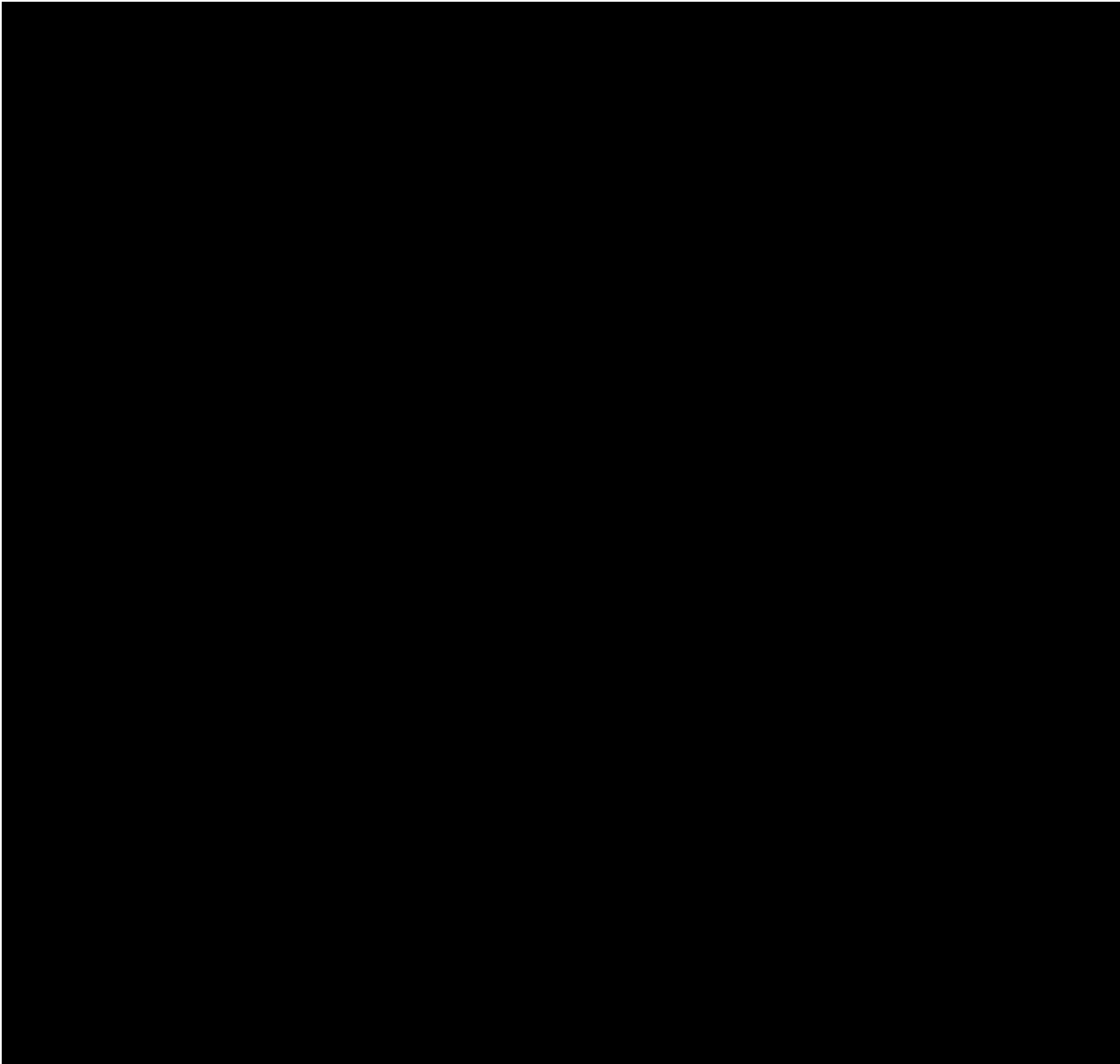




Table 3.3-1 provides an overview of the status of the key property rights required to construct and operate the Project.



Offshore Interconnection Route in Federal Waters

Per U.S.C. § 585.200(b), Vineyard Wind is entitled to one or more easements in which to locate the offshore cables in federal waters as needed to enable grid connection for offshore wind generation located in the Lease Area. [REDACTED]

Offshore Interconnection Route in State Waters

For the portion of the offshore interconnection route occurring in New York waters, permission to locate the export cables is granted through an easement issued by the New York Office of General Services (NYOGS) pursuant to New York Public Lands Law, Article 2, Section 3, 9 NYCRR Parts 270 and 271. NYOGS would issue the easement after the conclusion of the Article VII processes.

Onshore Interconnection Route

[REDACTED]

Onshore Substation

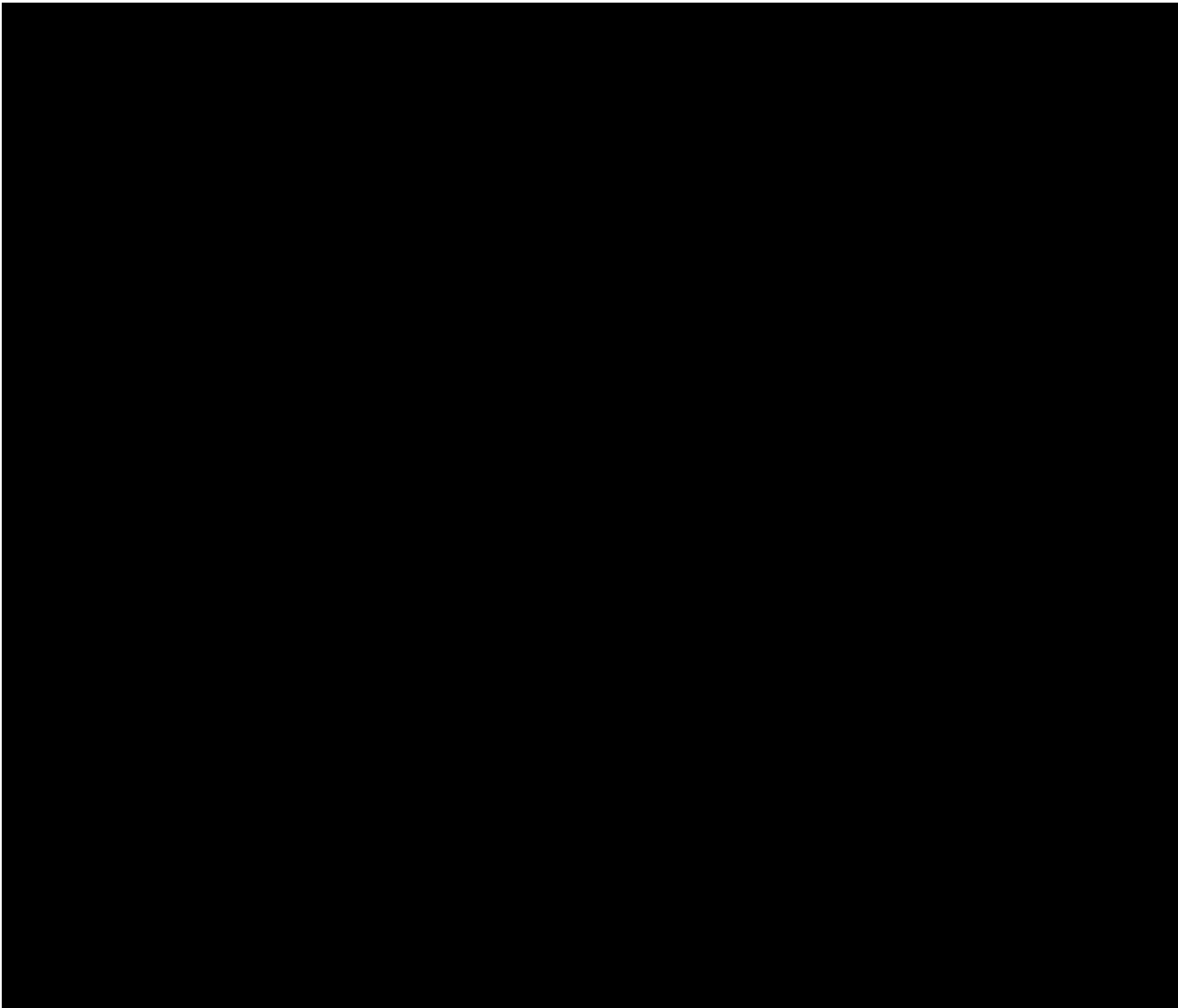
[REDACTED]

3.4 In addition to providing the required map(s), provide a site layout plan that illustrates the location of all on-shore and offshore equipment and facilities and clearly delineates the perimeter of the area in which offshore wind turbines will be placed. Identify the distance in statute miles between the nearest shoreline point and the nearest Offshore Wind Generation Facility turbines.

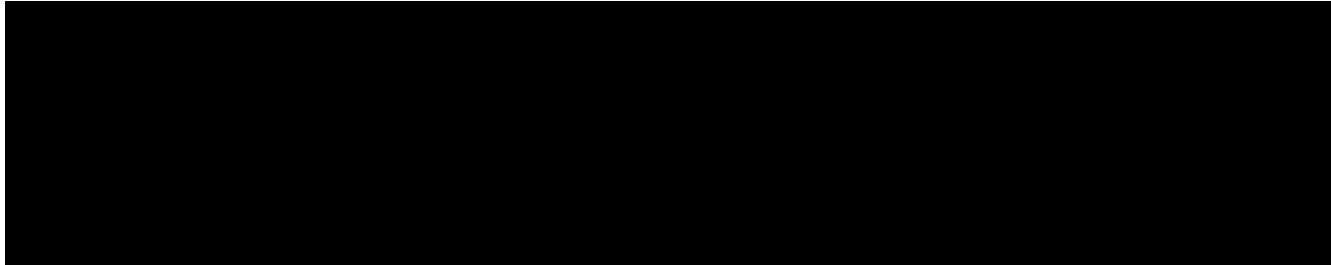
[REDACTED]

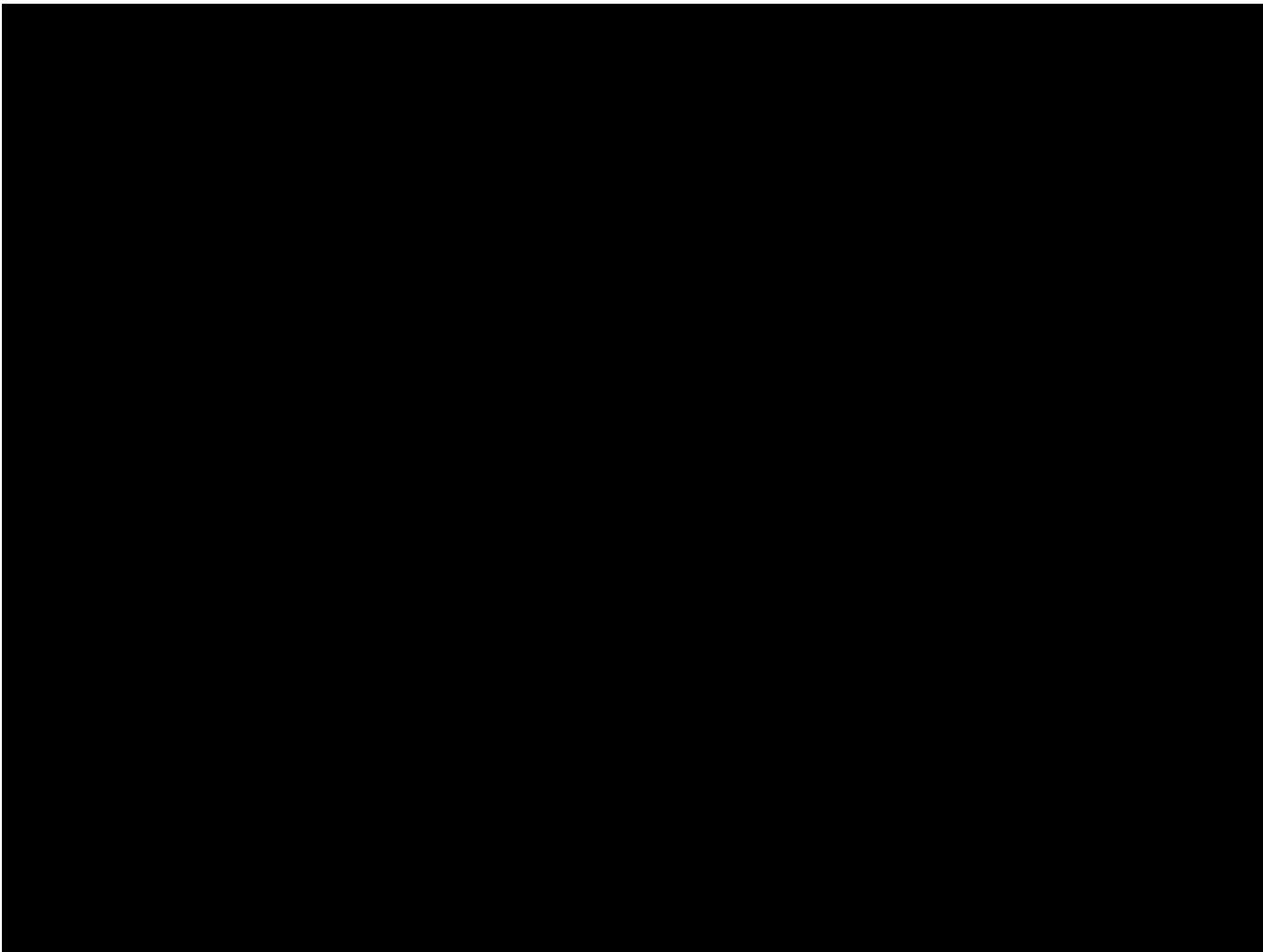
Offshore Wind Generation Facility Layout

[REDACTED]



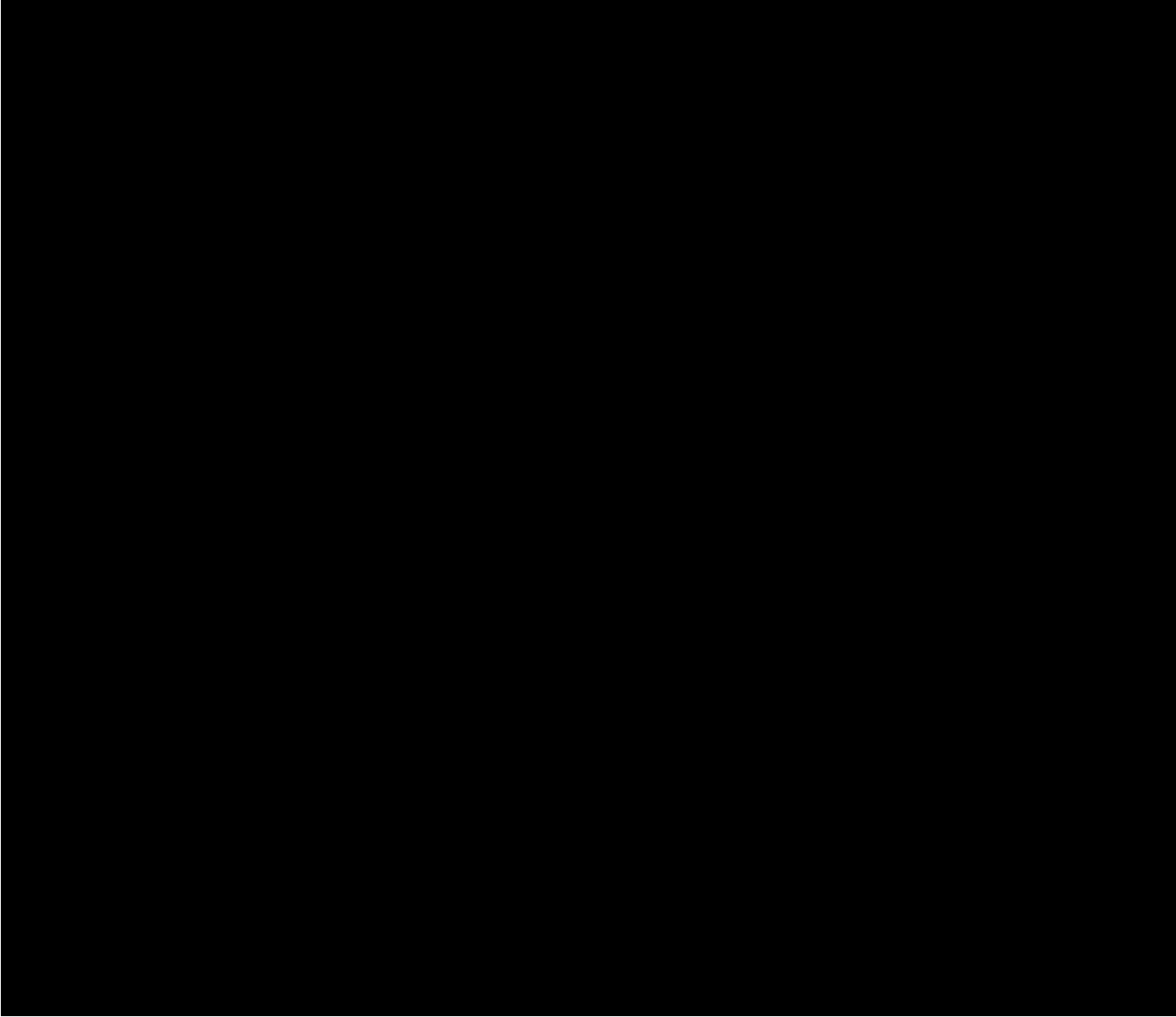
Distance to Shore

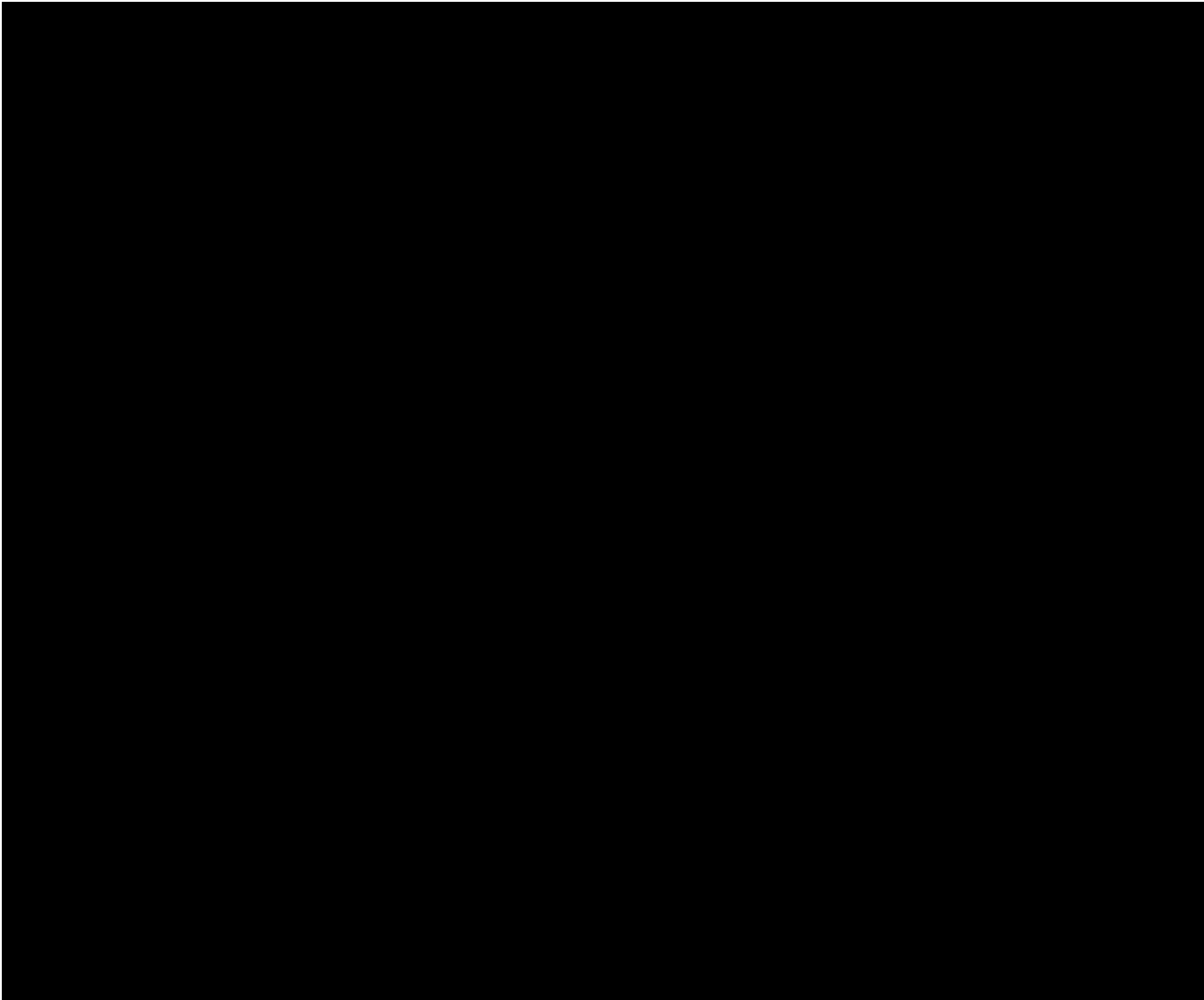


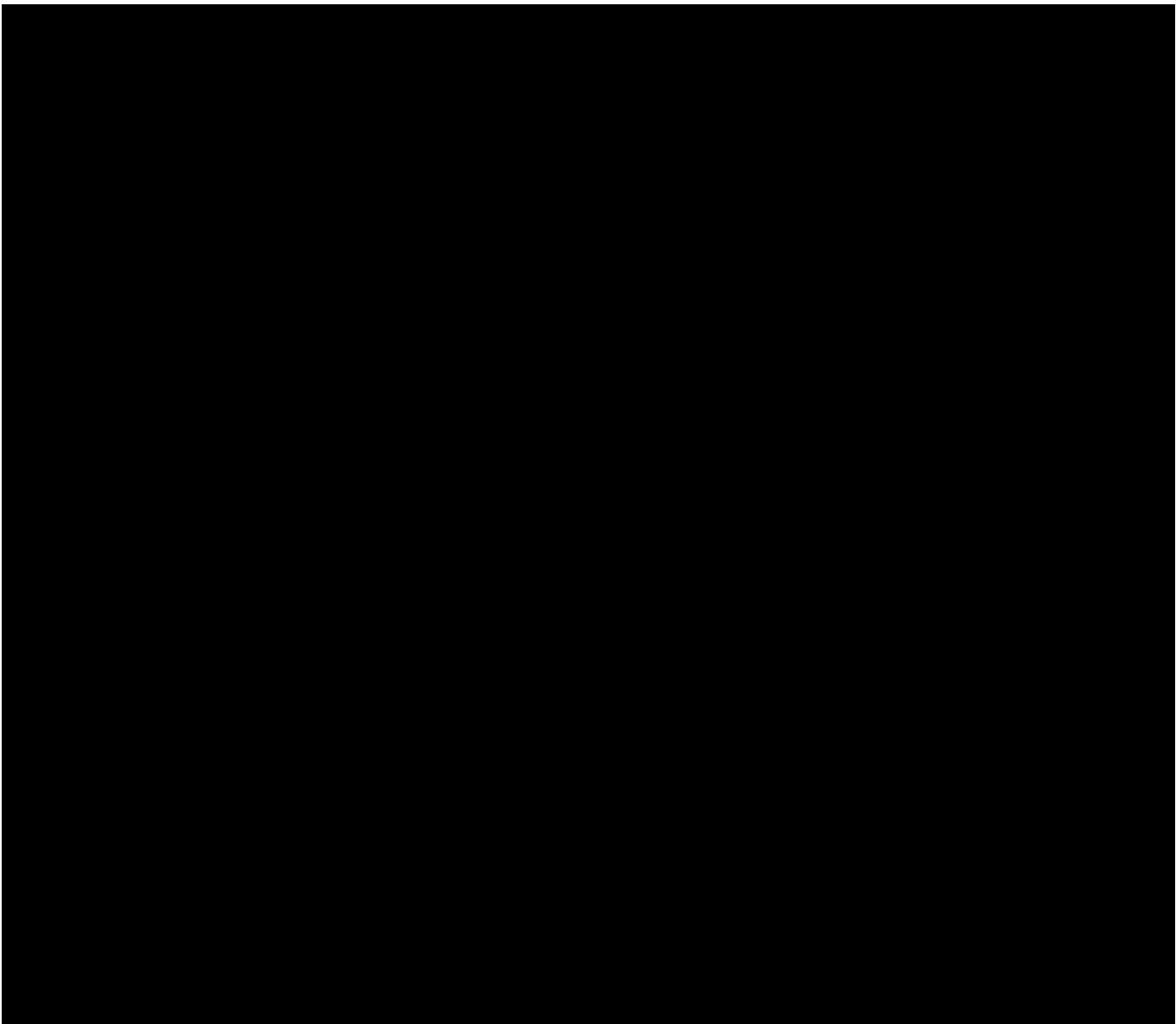




Onshore Facilities Layout









LIBERTY WIND

SECTION 4 - ENERGY RESOURCE PLAN

Proposal for New York State Energy Research and Development Authority in response to Request For Proposals for Purchase of Offshore Wind Renewable Energy Certificates



Photo: Veja Mate offshore wind farm

SECTION 4 ENERGY RESOURCE ASSESSMENT AND PLAN

OVERVIEW

Liberty Wind (the “Project”) is an offshore wind project Vineyard Wind is proposing to build in Lease Area OCS-A 0522 (the “Lease Area”). The Project consists of an Offshore Wind Generation Facility, located approximately 85 miles east of Long Island, and the transmission required to directly interconnect to the New York Control Area [REDACTED]

[REDACTED] Vineyard Wind is the designated a provisional winner of Lease Area OCS-A 0522 having successfully bid into the Bureau of Ocean Energy Management’s (BOEM) offshore wind auction on December 13-14, 2018. Vineyard Wind has a strong understanding of the wind conditions in the recently auctioned lease areas.

Vineyard Wind and its parent companies have every confidence in the ability to secure financing for the Project based on the annual energy production estimates included in this proposal and the ongoing wind resource assessment for the Offshore Wind Generation Facility. [REDACTED]

[REDACTED]

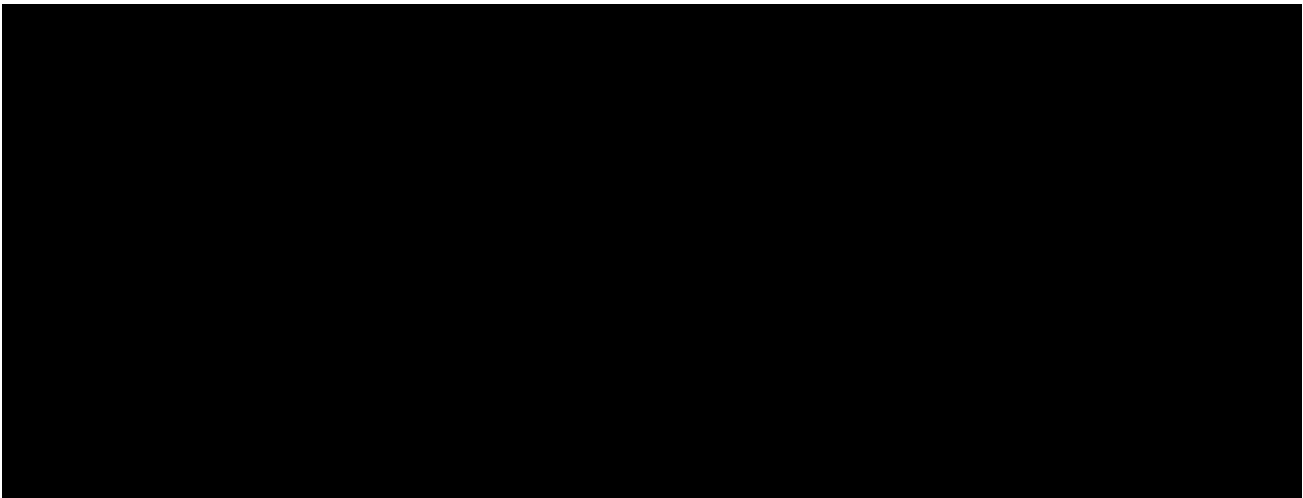
[REDACTED] The assessment established the confidence in the estimated annual energy production (p90) required to obtain project financing. These results are further being validated with onsite wind data from the Floating LiDAR that was installed in Lease Area OCS-A 0501 in May 2018.

[REDACTED]

[REDACTED] Vineyard Wind is very comfortable with the annual energy production estimates for Liberty Wind.

4.1 Provide a summary of all collected wind data for the proposed Offshore Wind Generation Facility site. Identify when and how (e.g., meteorological mast or LiDAR – for “Light Detection and Ranging”) the data was collected and by whom.

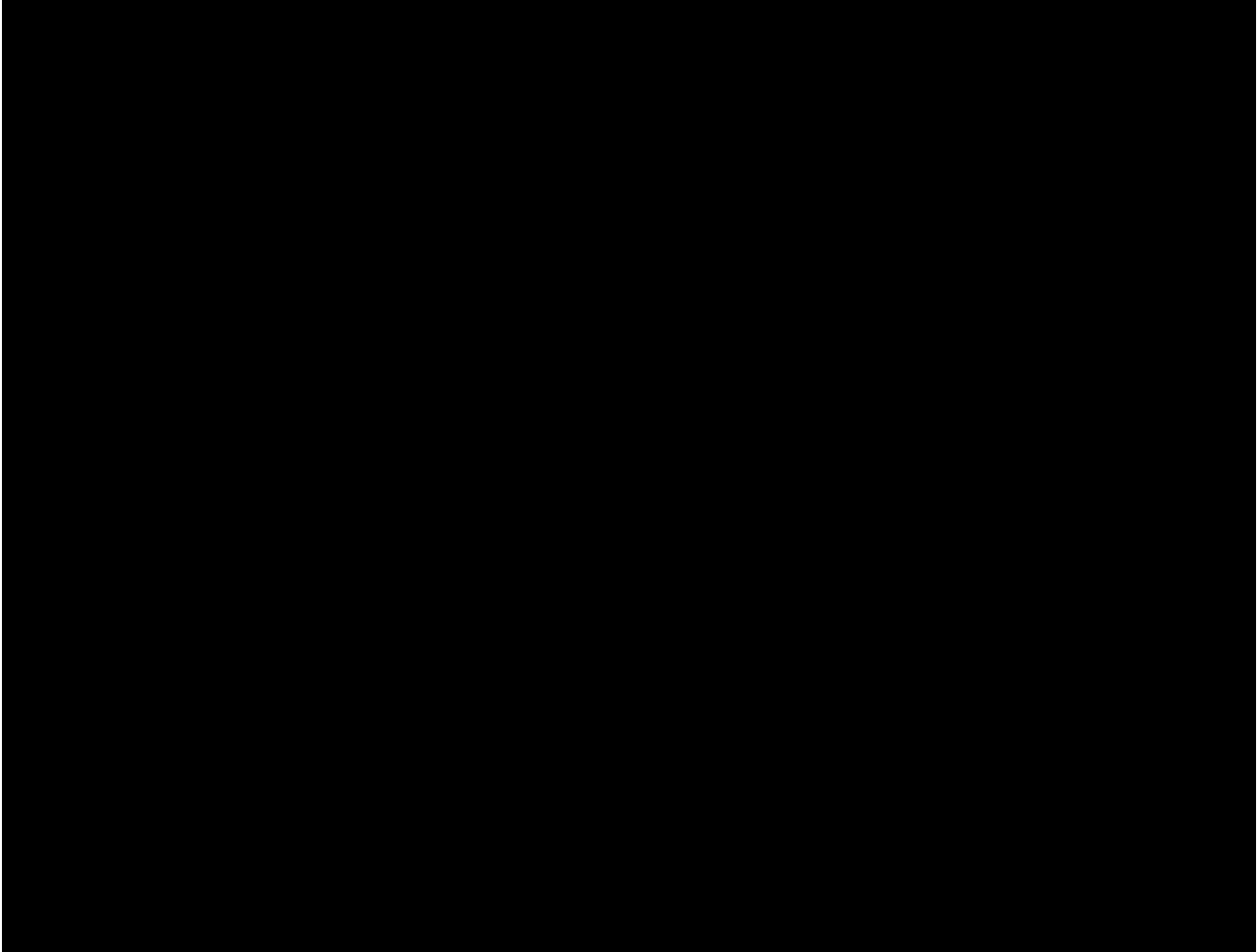
This section outlines the energy resource plan for the Offshore Wind Generation Facility site. Vineyard Wind has access to an extensive body of wind data collected from onshore and offshore measurement sites near Lease Areas OCS-A 0501 and OCS-A 0522. These data, which has been analyzed by Vineyard Wind using industry best practice and state-of-the-art methods to reduce the uncertainty of any energy production projections, indicate a favorable wind resource in both lease areas. Several independent wind resource assessments, produced at Vineyard Wind’s request, have previously confirmed the attractive wind regime in Lease Area OCS-A 0501.



Vineyard Wind deployed a FLiDAR in Lease Area OCS-A 0501 in May 2018



Figure 4.1-1 illustrates the locations of the wind datasets Vineyard Wind used in the analyses as well as the locations of the extensive wind assessment studies and production estimates completed by Vineyard Wind. The datasets are summarized in **Table 4.1-1**. Full detail on the datasets, including descriptions of the individual measurement stations and mesoscale data, can be found in **Attachment 4.1-1**.



The Project's wind resource assessment makes use of the most reliable wind data currently available. The primary data sources and methods used in the wind resource and energy production estimates are:

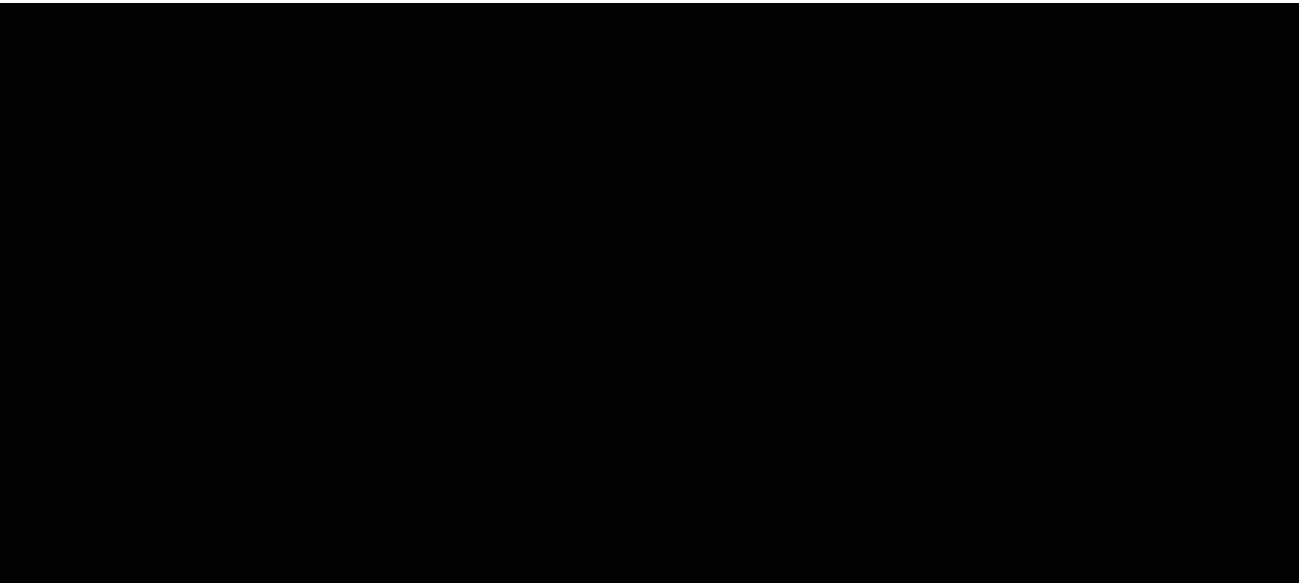
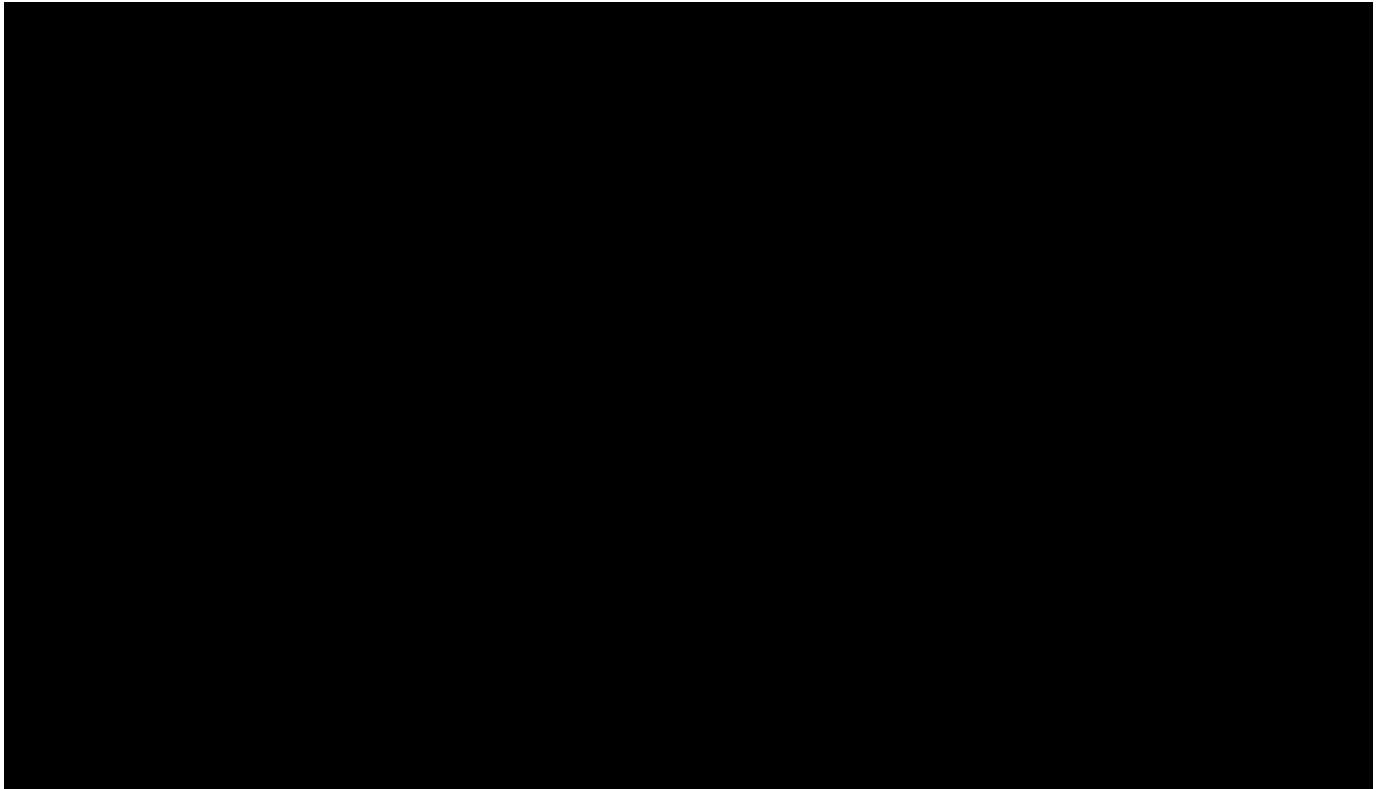
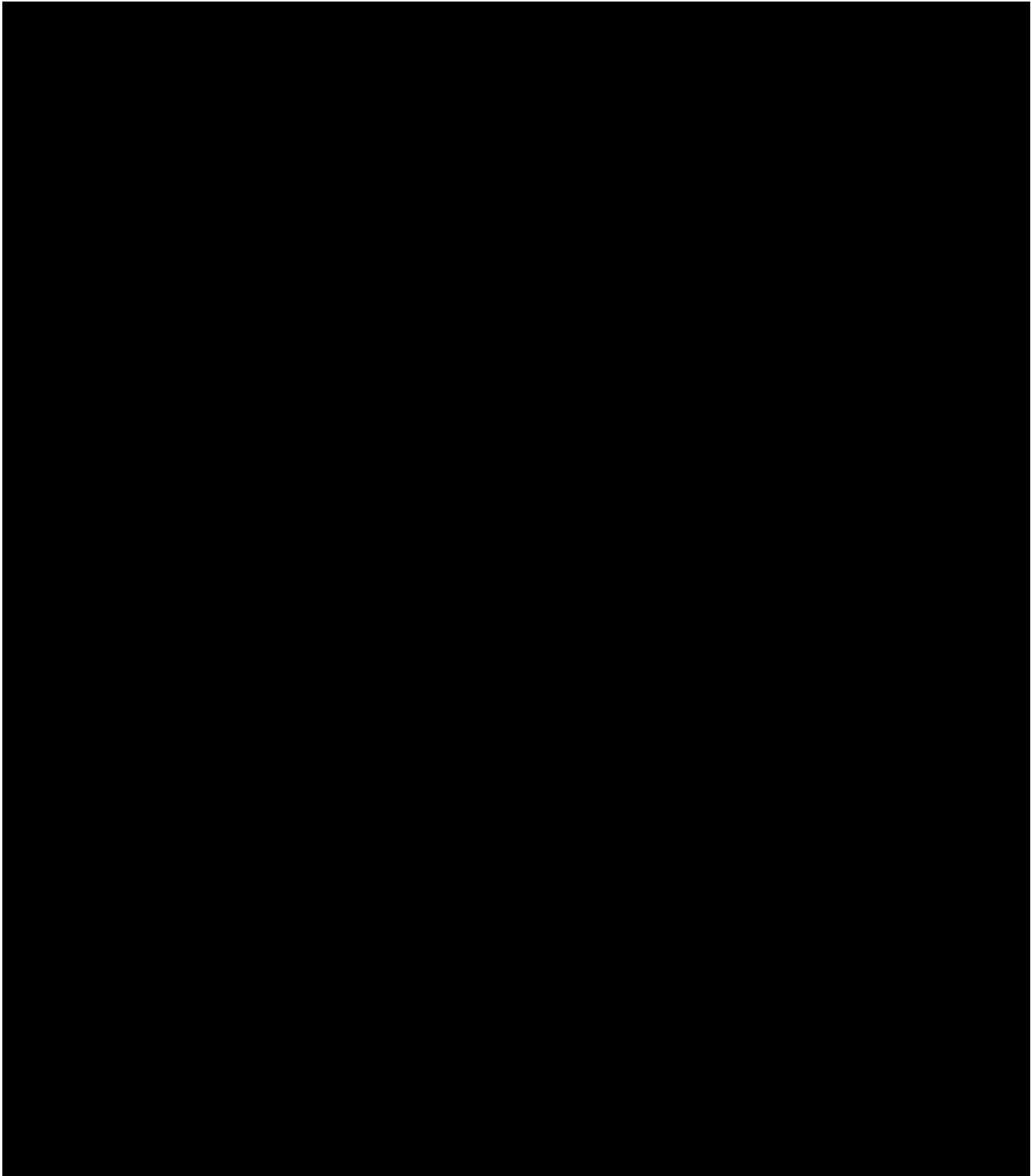


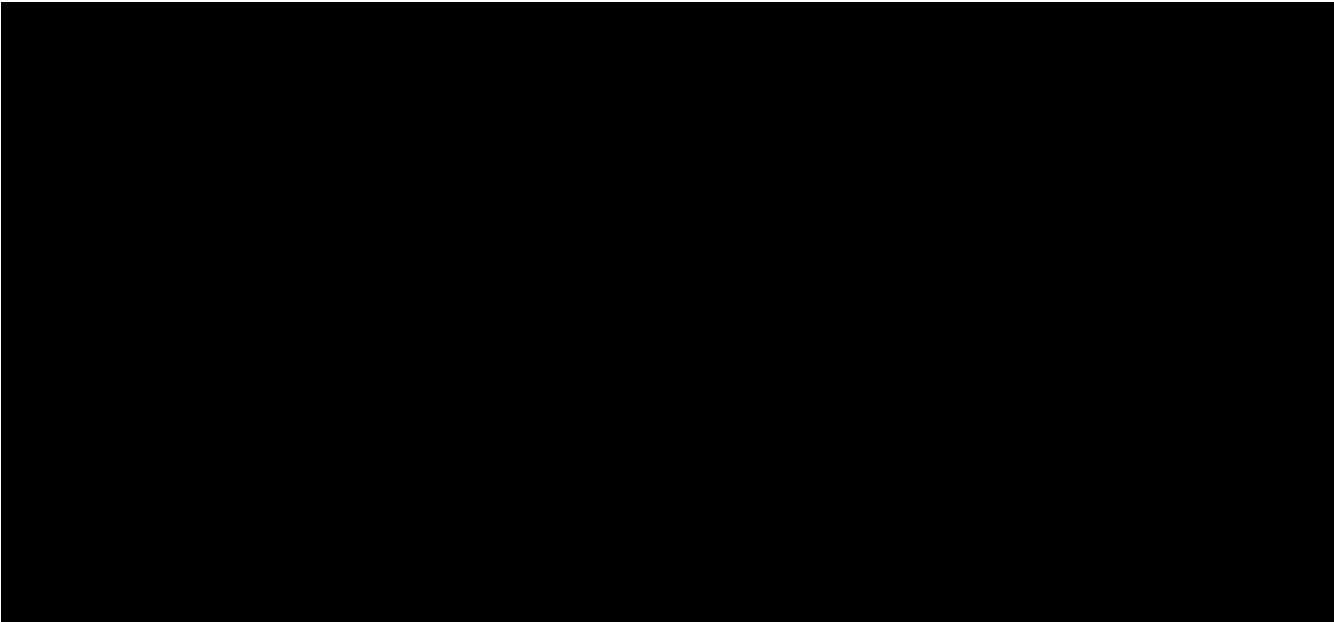
Figure 4.1-2 illustrates the time spans covered by each time series of measurement points from the locations shown in **Table 4.2-1**.



4.2 Indicate where the data was collected and its proximity to the proposed Offshore Wind Generation Facility site. Include an identification of the location and height for the anemometers and/or “range gate” heights for sensing by LiDAR that were used to arrive at an assessment of the site generation capability. Describe any additional wind data collection efforts that are planned or ongoing.

Details of the data collection points and the locations of the additional sources shown in **Figure 4.1-2** are summarized in **Table 4.2-1** below.

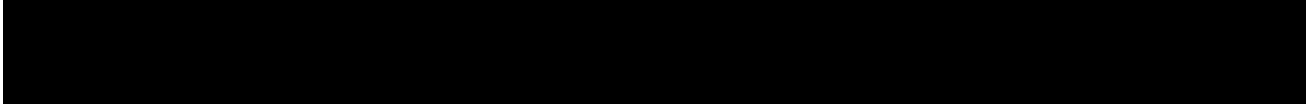




ADDITIONAL WIND DATA COLLECTION EFFORTS


Vineyard Wind’s wind resource assessment methodology incorporates best practices from the European offshore wind sector and has been successfully used in the development of multiple offshore projects in Europe.






4.3 *Provide at least one year of hourly wind resource data. Data collected from the site is preferred, though projected data is permissible. The method of data collection must also be included. Provide a wind resource assessment report for the Proposed Offshore Wind Generation Facility site. Include an analysis of the available wind data which addresses the relationship between wind conditions and electrical output.*

NET ANNUAL ENERGY PRODUCTION

Gross and net-after-wake wind turbine production have been calculated using the wind climate derived for the Lease Area OCS-A 0522 taking into account the Offshore Wind Generation Facility's layout. 




 See **Attachment 4.3-1** for additional detail on turbine layout and yield calculations.

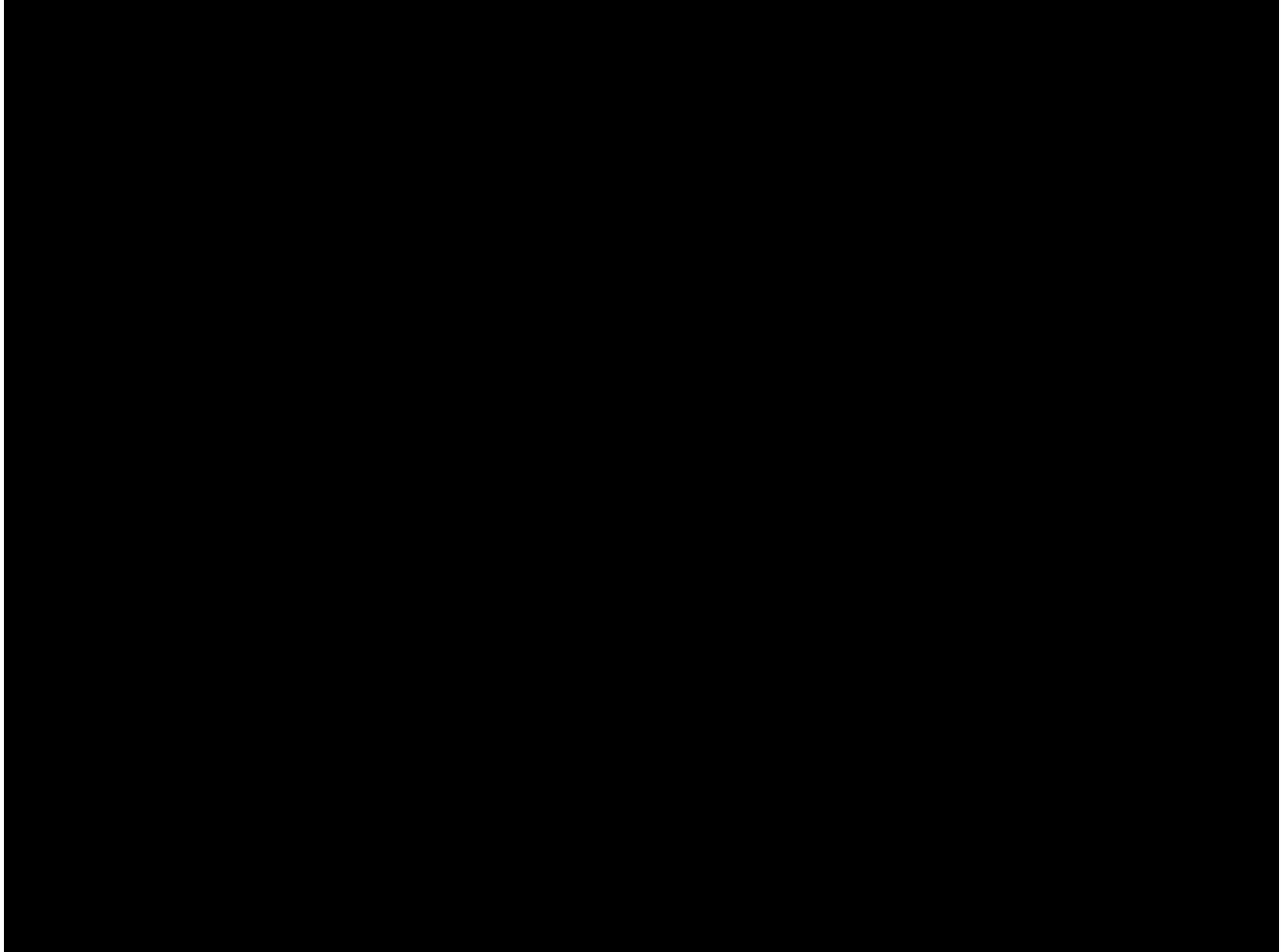


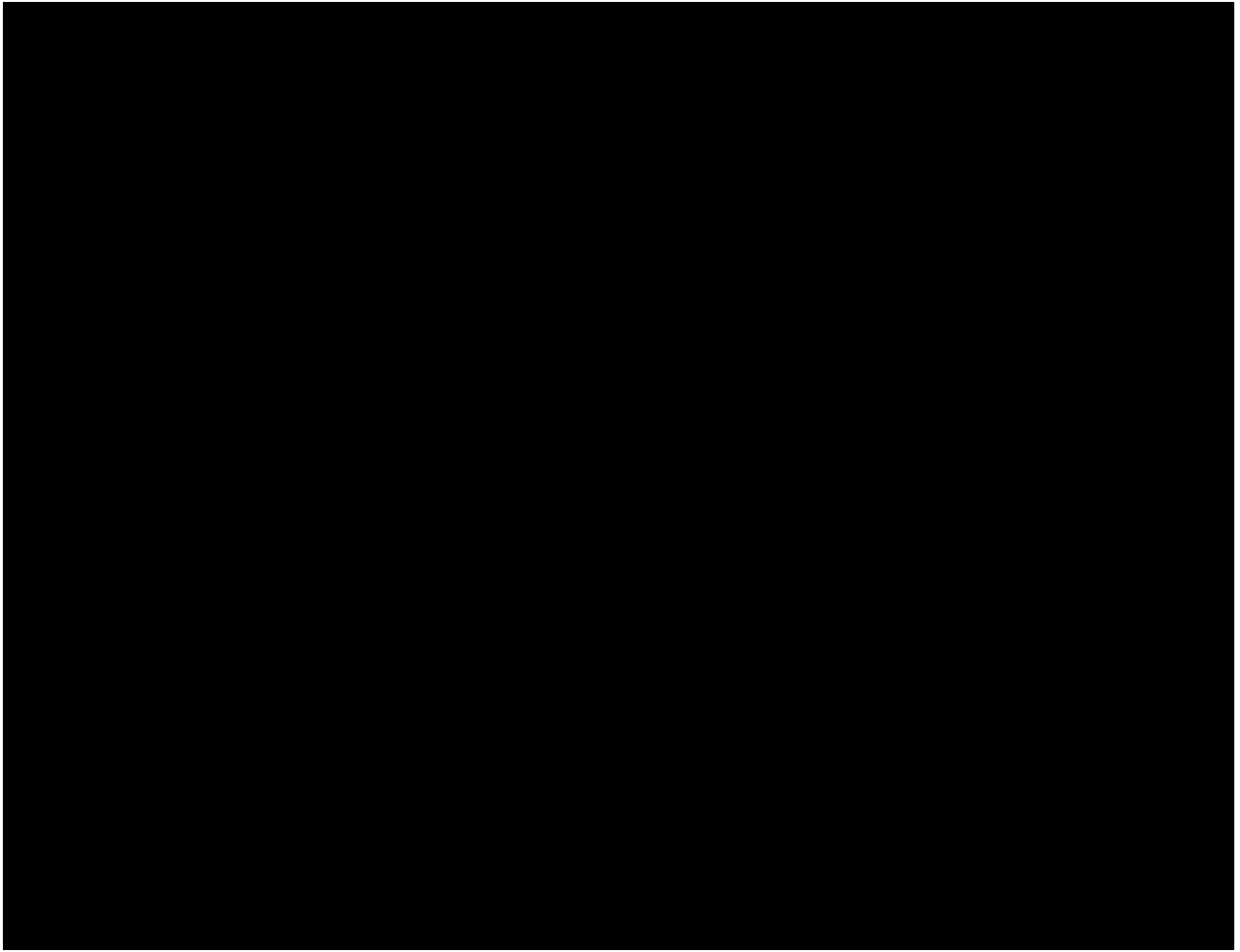
The losses used in the calculations of projected annual energy production are provided in **Table 4.1-2** and described in detail in **Attachment 4.1-1**. The rationale for the ascribed values for each case can be found in **Attachment 4.3-1**.



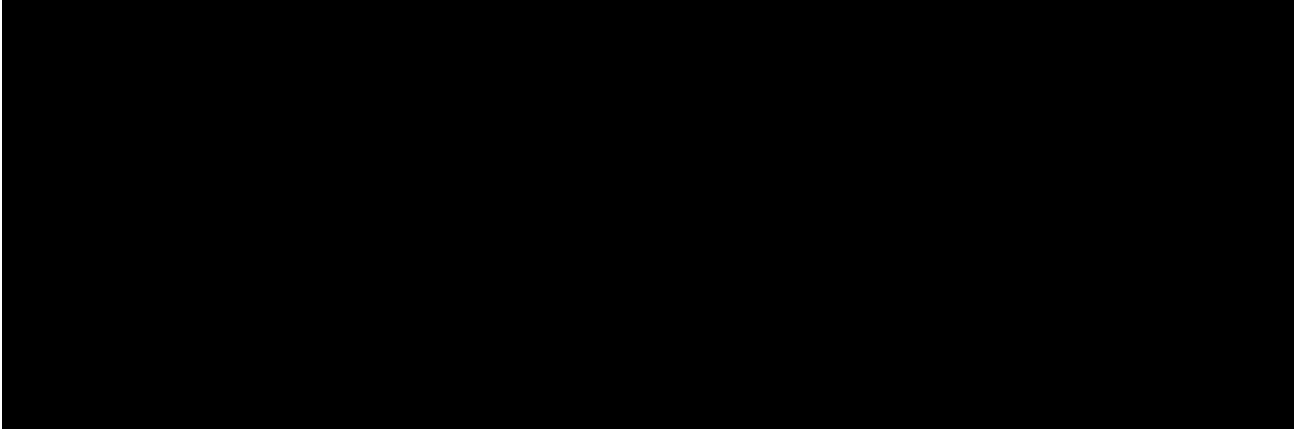
 As a result, the Project's energy delivery plan is robust.




All of the energy production numbers shown below are net-after-wake values and all losses have been accounted for. Projections of net annual energy production, including projections of average net hourly energy production, based on the wind resource data (a 12 x 24 energy projection) at p50 and p90 levels are shown in **Table 4.3-2** and **Table 4.3-3**, respectively. The sum of all values is equal to the net energy production (at the metering point) as shown in **Table 4.3-1**.

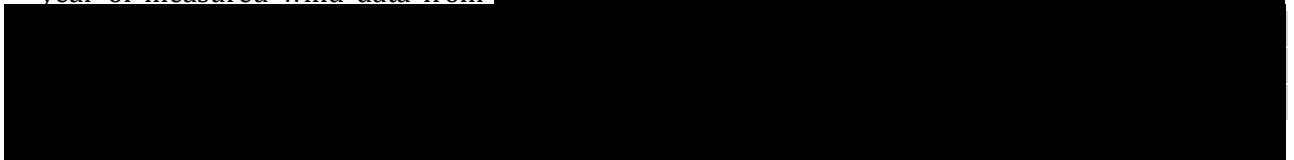





METHODOLOGY

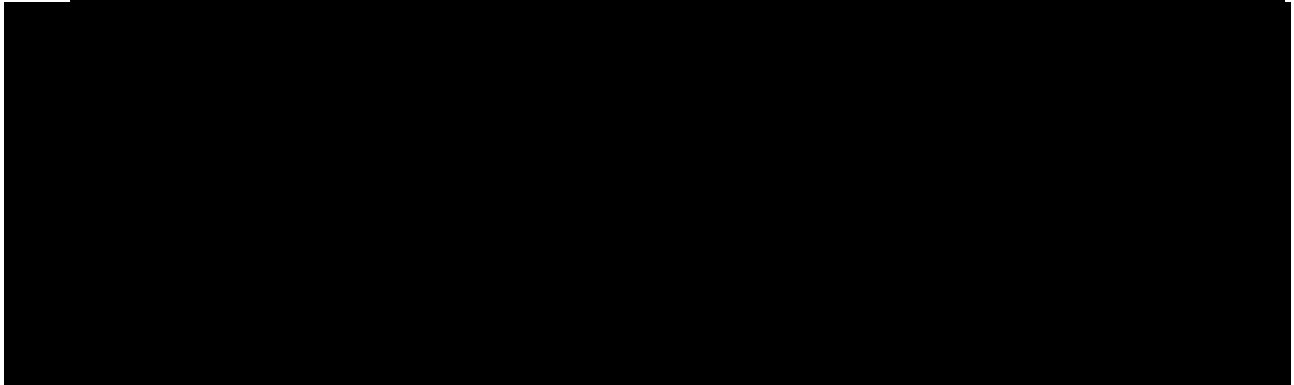


 The described method utilizes best-in-class energy production methods and tools, including the wind resource assessment report developed . The report includes a detailed description of the methodology used to produce the assessment. **Attachment 4.3-2** provides one year of measured wind data from 

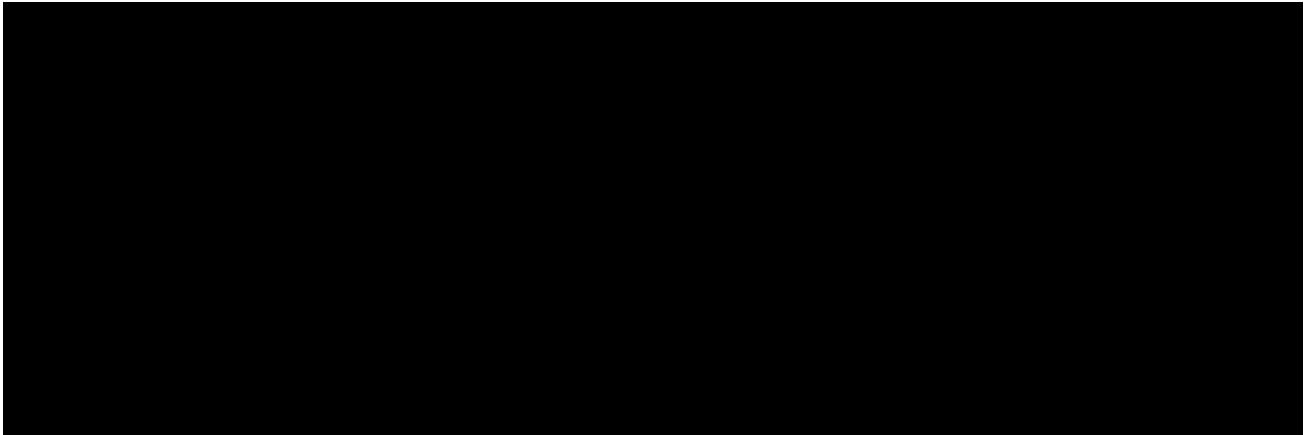



The wind resource assessment  was developed by C2Wind, one of the most experienced wind energy forecasting companies in the world. C2Wind's experts have been working in offshore wind since 2003 and have more than 50 years' combined experience in offshore wind resource assessment and energy production estimation. C2Wind's team has worked with the top five offshore wind turbine suppliers and has first-hand experience with and special insights into turbine behavior and key support structure design drivers. Additionally, C2Wind's experts are working with the leading offshore wind companies globally and have been involved in more than 20 offshore wind projects across the world.

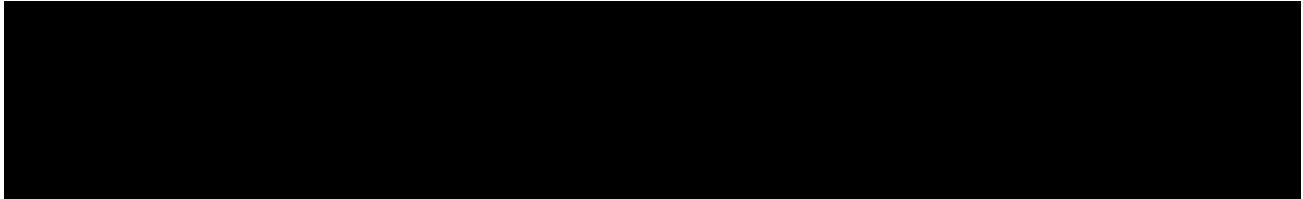
C2Wind drafted the wind resource assessment report using the data sources described in **Table 4.2-1**. 



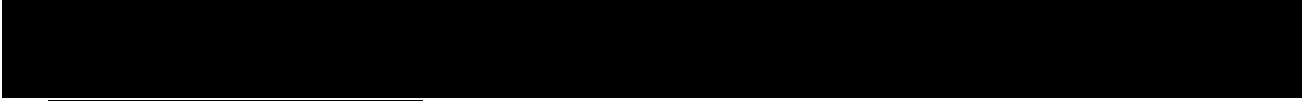
WIND RESOURCE ASSESSMENT




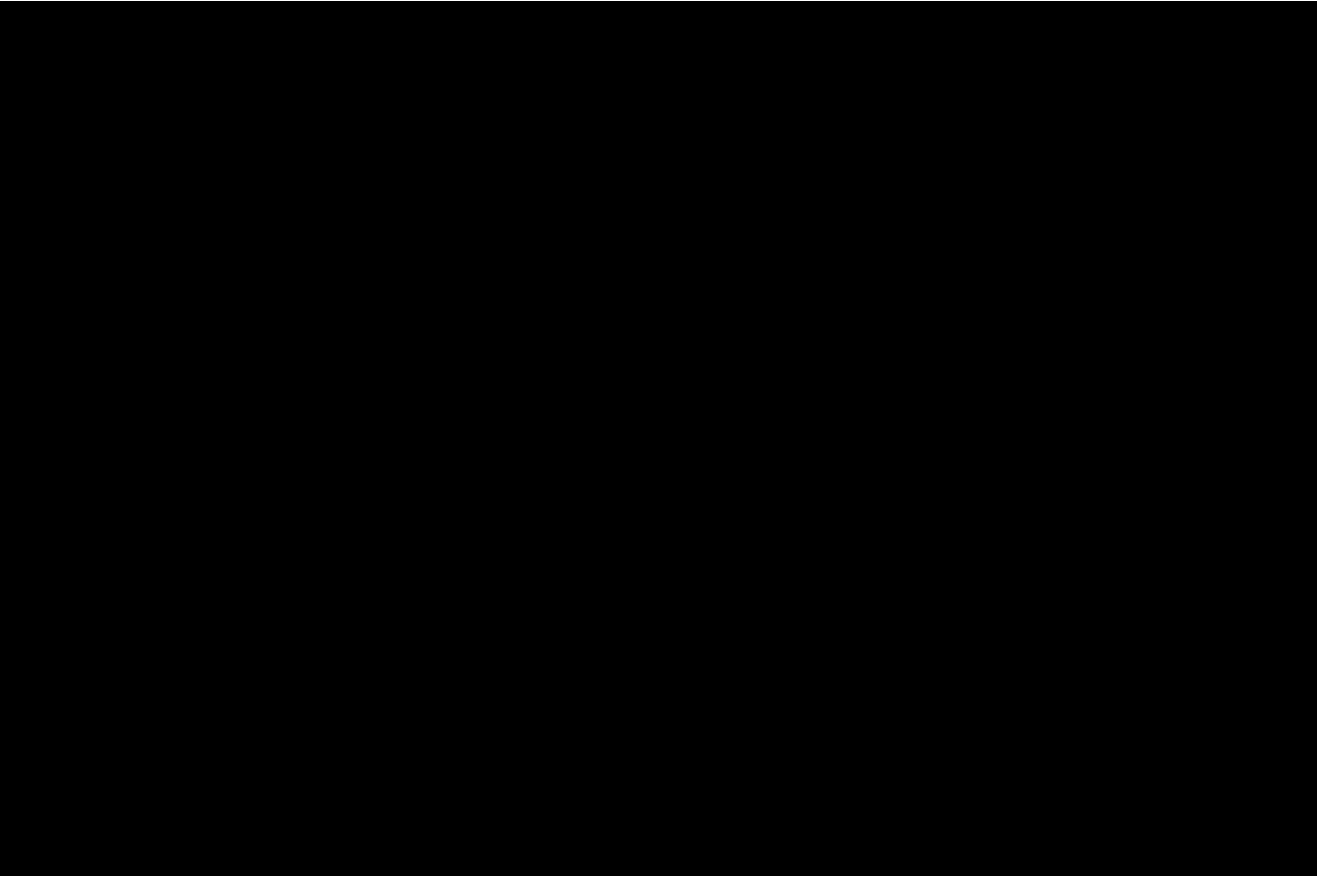
 the following public wind energy resource maps provided by NREL: Wind Powering America map, available at: <https://www.eia.gov/todayinenergy/detail.php?id=4770> and Wind Prospector, available at: <https://maps.nrel.gov/wind-prospector>.



4.4 *Provide a site-adjusted power curve. Each curve should list the elevation, temperature and air density used.*

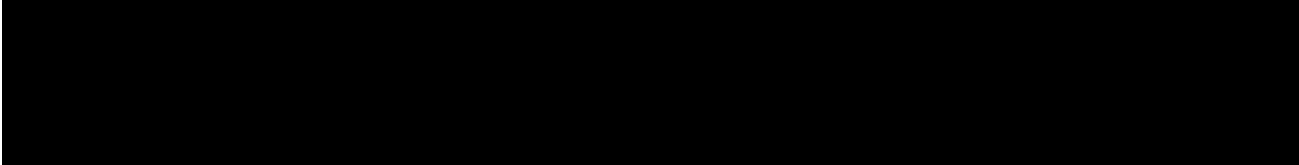


 A site-adjusted power curve listing the elevation, temperature, and air density used is provided as **Attachment 4.4-1**.



SECTION 5
OPERATIONAL PARAMETERS

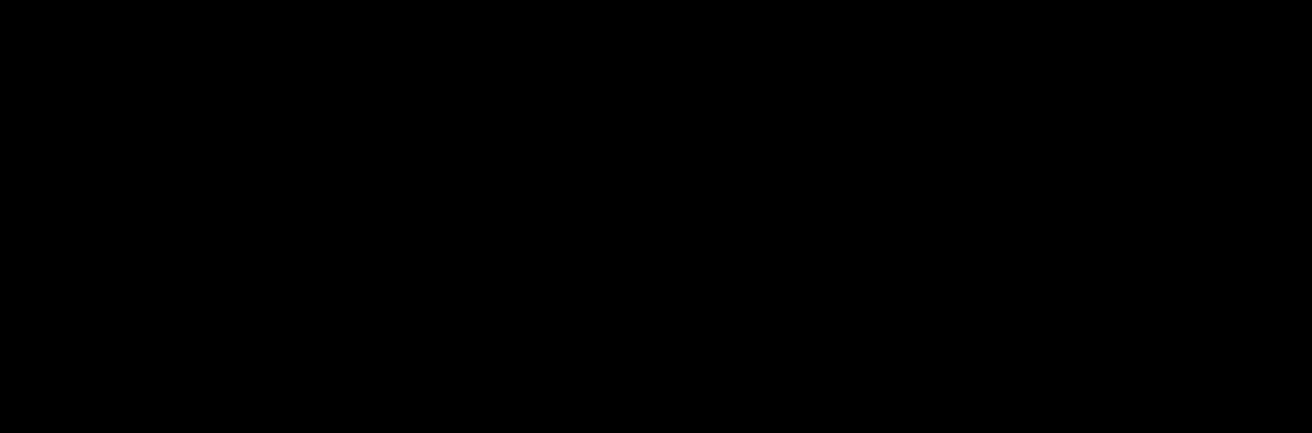
5.1 *Maintenance Outage Requirements – Provide partial and complete planned outage requirements in weeks or days for the Offshore Wind Generation Facility. Also, list the number of months required for the cycle to repeat (e.g., list time interval of minor and major overhauls, and the duration of overhauls).*



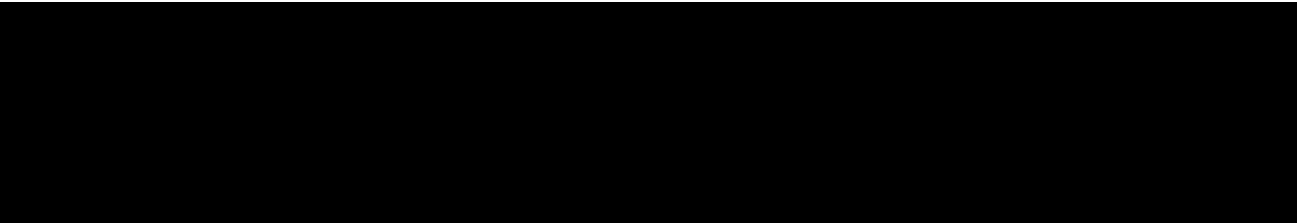
MAINTENANCE OUTAGE REQUIREMENTS



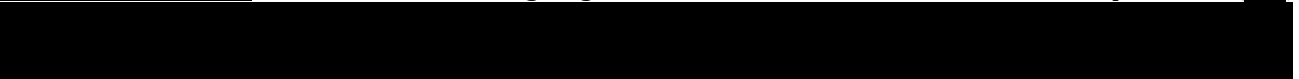
The New York Independent System Operator (NYISO) will be informed of planned maintenance campaigns well in advance to minimize the system impacts of any outages. Maintenance outages for the various Project components are shown in **Table 5.1-1** below.



Wind Turbine Generators



The WTGs not undergoing maintenance would remain online and operational.



Electrical Service Platform



In-depth maintenance is necessary to ensure the safe and reliable operation of the Project, which in turn supports improved stability and reliability. Measures will be taken to optimize the timing of this work, such as aligning it with other outages (e.g., onshore substation outage), in order to reduce the overall production loss. Any required full outage will be planned well in advance and coordinated with NYISO.

Inter-array Cables

During normal operations, scheduled inspections can be carried out on the inter-array cables without the need for an outage. No planned outages are expected for the inter-array cables.

Offshore and Onshore Export Cables

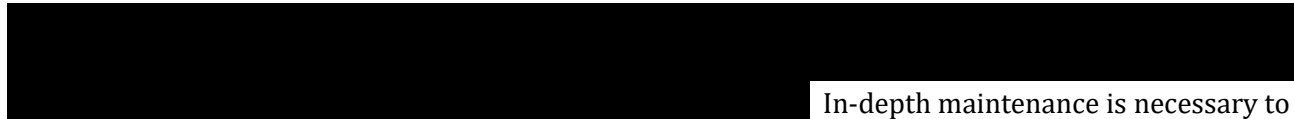
During normal operations, scheduled maintenance can be carried out on export cables without the need for an outage. No planned outages are expected for the export cables.

Onshore Substation

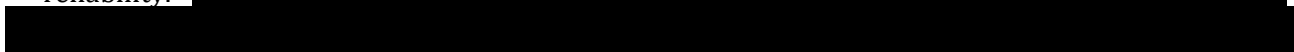
Scheduled maintenance of onshore substation components will take place at predefined intervals, in accordance with the manufacturer’s recommendations and in coordination with NYISO.




Lastly, the work will be planned in collaboration with the NYISO in order to minimize any potential disruption to the grid.



In-depth maintenance is necessary to ensure the safe and reliable operation of the Project, which in turn supports improved stability and reliability.



 Any required full outage will be planned well in advance and coordinated with NYISO.

5.2 *Operating Constraints – Provide all the expected operating constraints and operational restrictions for the Project, the reason for the limitation, and characterize any applicable range of uncertainty.*

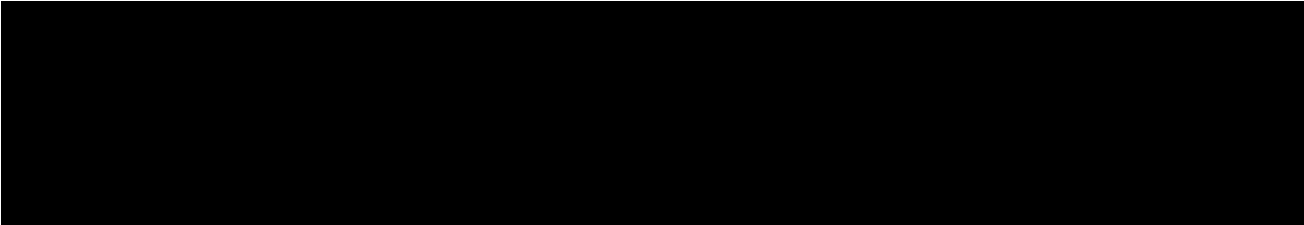


OPERATIONAL LIMITS

The WTGs and related structures are designed to withstand the harsh offshore climate. 

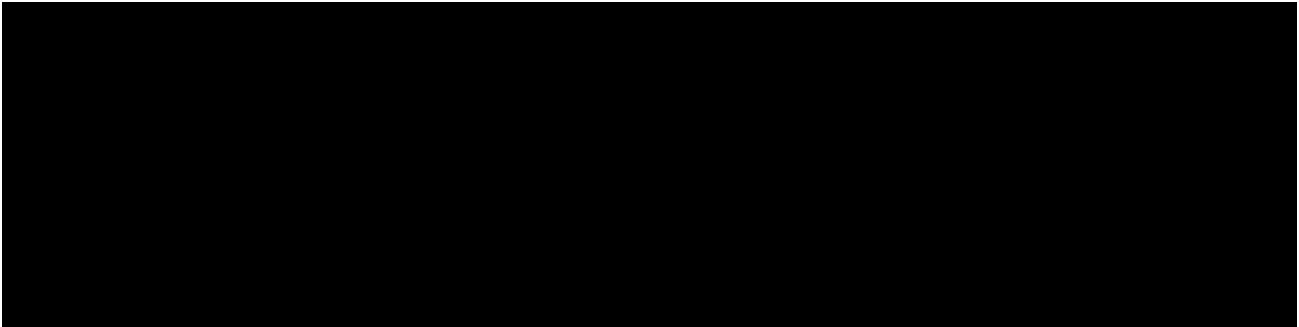


Temperature



These parameters have been taken into account in the WTG availability calculation.

Wind Speeds



These parameters have been taken into account in the WTG availability calculation.

SCHEDULED MAINTENANCE



The WTGs

will be serviced according to the manufacturer’s recommendations and any applicable regulatory requirements. [REDACTED]

UNSCHEDULED MAINTENANCE

Unscheduled maintenance, which includes unscheduled repairs and the replacement of damaged components as well as cable untwisting, automatic system tests, and remote resets, can be planned only to a limited degree and may take place at any time throughout the year. [REDACTED]

Turbine Condition Monitoring

TCM systems measure vibration and acceleration in specific components in the wind turbine, typically including the WTG's Main hub bearing, Main shaft, Gearbox, Generator and Tower.

The vibrations and accelerations are measured and sent to a centralized computer system. When defined levels are exceeded, an alarm is issued. If necessary, the WTG will automatically initiate a forced shut down until the root cause has been identified and mitigating actions has been completed.



Supervisory Control and Data Acquisition

A large number of sensors are connected to the SCADA system in both the WTGs and substations where they gather information, such as temperature, pressure, positions. Collected data is transferred to a centralized computer system where it is used to set up monitoring routines and evaluate the state of the asset. Project components are analyzed continuously by trained technicians to identify early indications of wear, tear, or upcoming breakdown. Should a breakdown occur, SCADA data is analyzed to identify the root cause of the breakdown.

Liberty Wind's preventive maintenance strategy will reduce the need for unscheduled maintenance and maintain a high availability of the Project.



LIBERTY WIND

SECTION 6 - BUSINESS ENTITY AND FINANCING PLAN

Proposal for New York State Energy Research and Development Authority in response to Request For Proposals for Purchase of Offshore Wind Renewable Energy Certificates



Photo: Veja Mate offshore wind farm

SECTION 6 BUSINESS ENTITY AND FINANCING PLAN

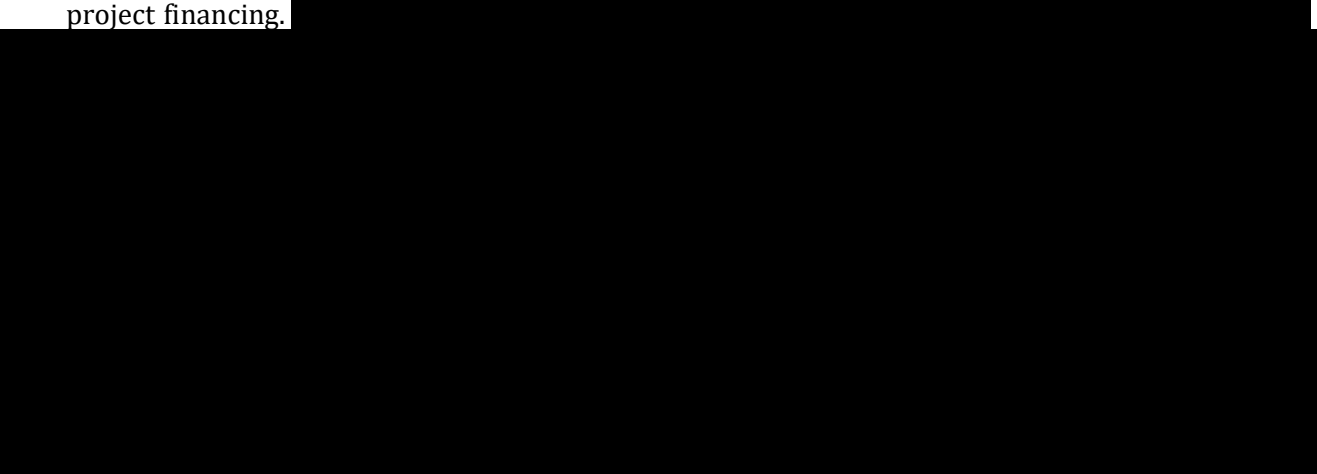
Proposers are required to demonstrate the financial viability of their proposed Project. Proposers should provide the following information:

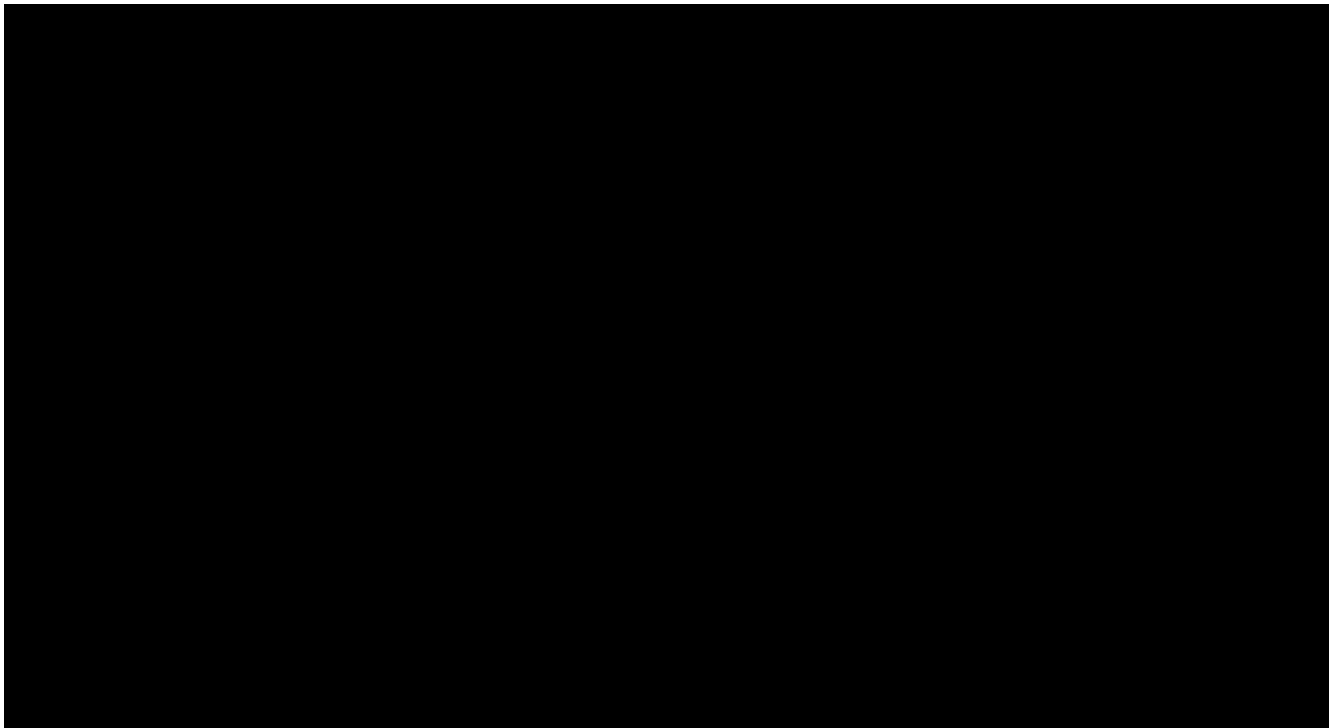
- 6.1 Submit information and documentation that demonstrates that a long-term contract resulting from this RFP process would either permit Proposers to finance Proposals that would otherwise not be financeable or assist Proposers in obtaining financing of its Proposal.*
-

FINANCIAL VIABILITY OF THE PROPOSERS

Vineyard Wind LLC (Vineyard Wind) is owned by two funds managed by Copenhagen Infrastructure Partners P/S (CIP) and Avangrid Renewables LLC (Avangrid Renewables) (together the “parent companies”). Both companies contribute considerable financial strength to Liberty Wind (the “Project”) and a stellar track record developing, constructing and operating renewable energy and offshore wind projects across the globe. Vineyard Wind’s parent companies’ commitment to provide the equity investments needed to finance the Project is predicated on executing long-term contracts for the Project’s Offshore Renewable Energy Credits (ORECs), provided that certain additional conditions are met as described in the letters included as **Attachments 6.1-1** and **6.1-2**. This requirement is consistent with the parent companies’ prior business practices in other large power development projects in the US and internationally.

A long-term contract for the Project’s ORECs will make it possible for Vineyard Wind to obtain financing by guaranteeing a purchaser for the ORECs and providing certainty with respect to the price that will be paid for these attributes for a large part of a Project’s economic life. This removes one of the largest economic uncertainties in estimating the future income of an offshore wind project, thus lowering the risk to investors and lenders, and, ultimately, ratepayers. Project development on a non-contracted basis, even for renewable energy credits, can be extremely challenging and, in the view of the parent companies, is not possible for the Project. The banks and financial advisors consulting with Vineyard Wind have confirmed the importance of long-term contracts to secure project financing.





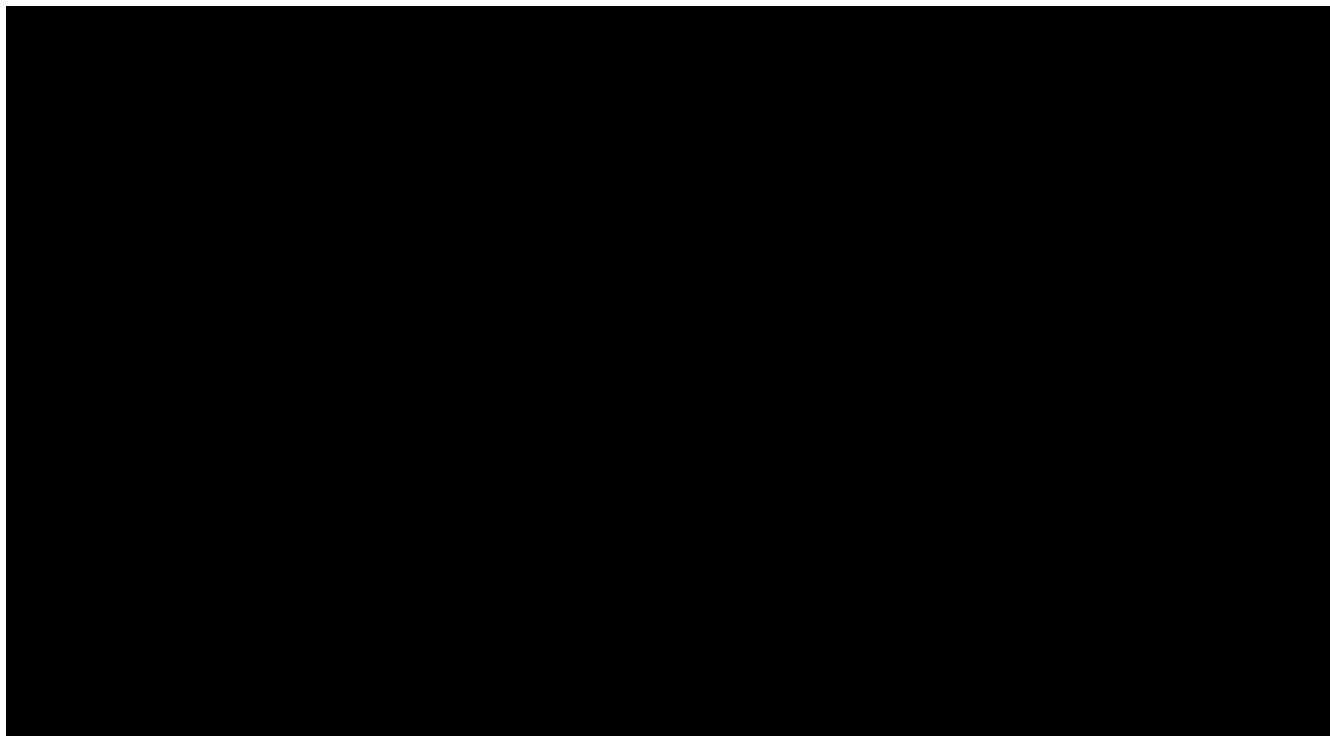
6.2 *Describe the business entity structure of Proposers' organization from a financial and legal perspective, including all general and limited partners, officers, directors, managers, members and shareholders, and involvement of any subsidiaries supporting the Project. Provide an organization chart showing the relationship among the different Project participants. For joint ventures, identify all owners and their respective interests, and document Proposers' right to submit a binding Proposal.*

BUSINESS ENTITY STRUCTURE

Liberty Wind will be developed by Vineyard Wind in collaboration with ADP. The business entity structure for Vineyard Wind and ADP, in relation to the Project, is illustrated in **Figure 6.2-1** and explained below.

Vineyard Wind, a Delaware limited liability company registered in Massachusetts, is indirectly owned by two investment funds, each of which own 25% of the company that are managed by CIP. The remaining 50% of Vineyard Wind is owned by Avangrid Renewables (see **Figure 6.2-1**). Collectively, Vineyard Wind's three investors are referred to as the parent companies.



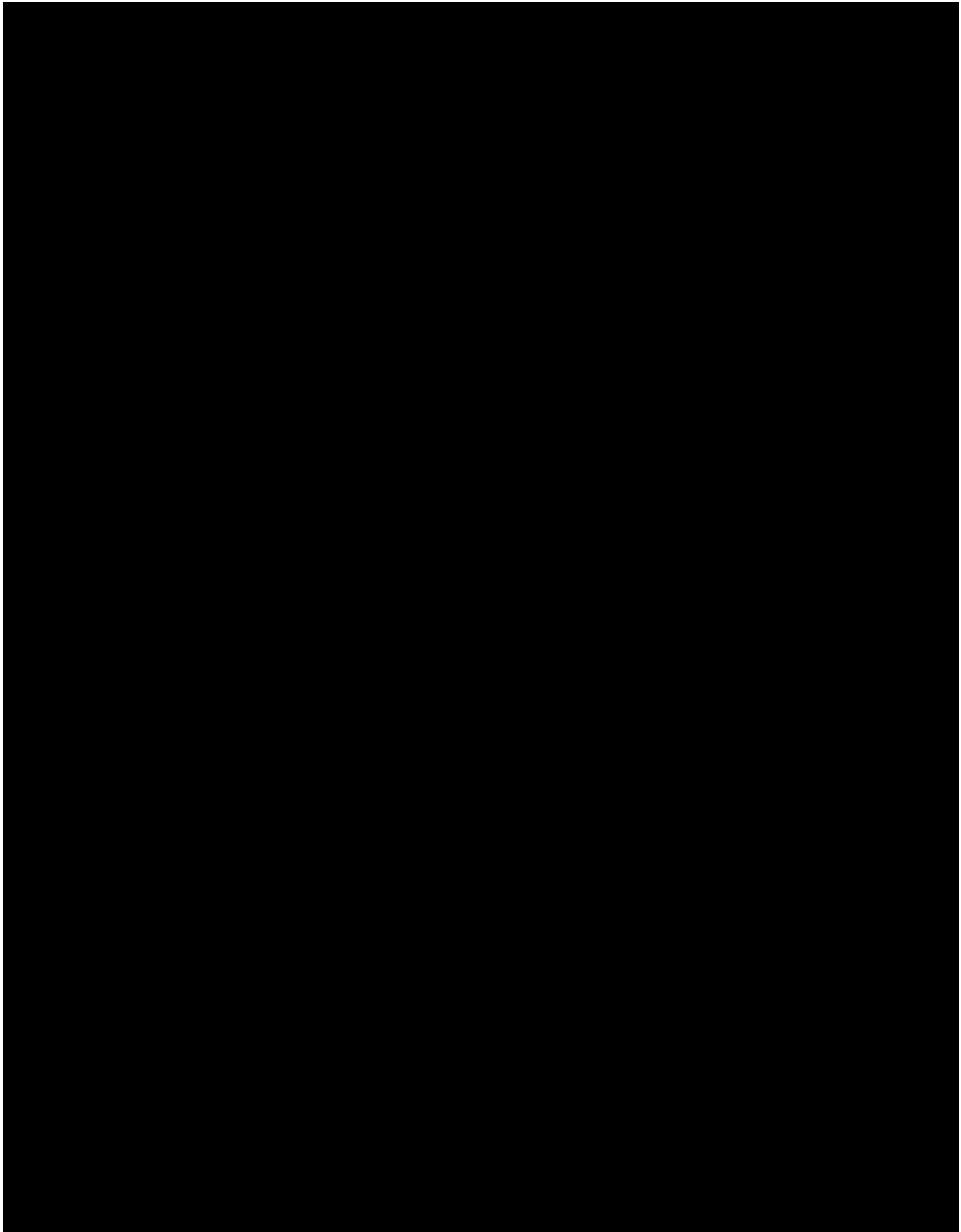


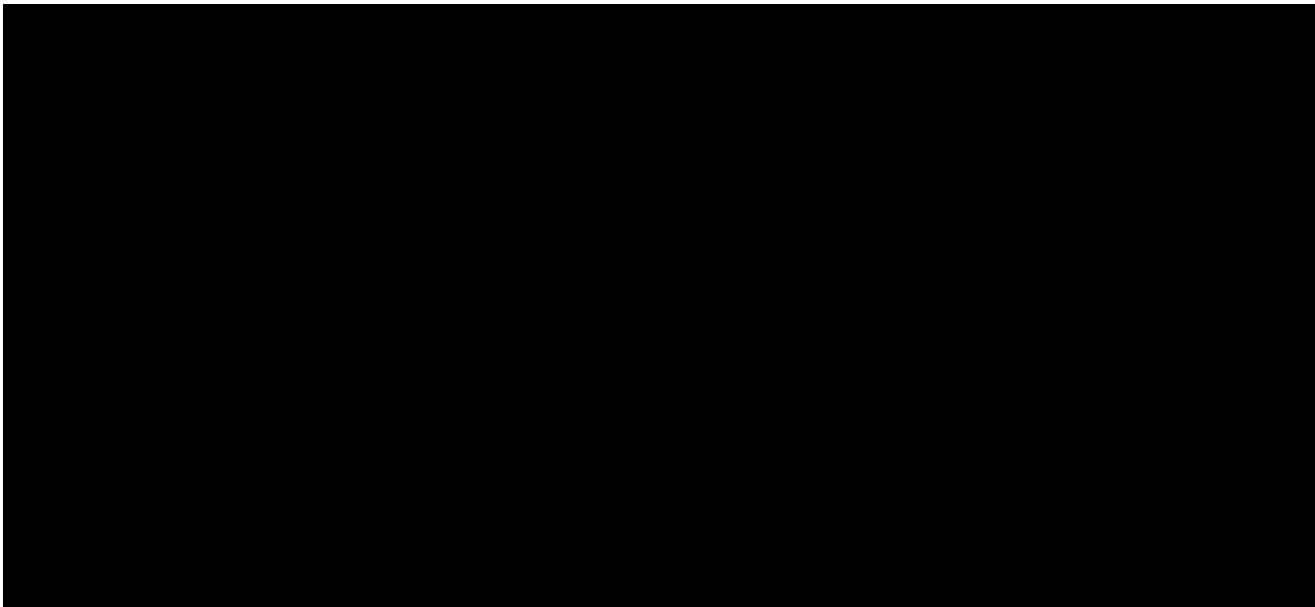
Vineyard Wind believes this joint approach serves as a model for how an offshore wind generator and an independent transmission developer, with separate ownership of their respective project components, can partner to successfully develop and deliver cost-effective offshore wind projects. This approach also respects the longstanding policy of unbundled ownership of generation and transmission assets in deregulated electricity markets and will facilitate further development of this approach in NYSERDA's future offshore wind solicitations.

VINEYARD WIND LLC

Vineyard Wind's governance structure is comprised of experienced teams that have been involved in the successful construction and operation of many offshore wind projects. The company's ultimate governance body is the Board of Managers, with operational matters directed by an Executive Committee, and day-to-day matters controlled by Vineyard Wind's officers. An organizational chart showing all officers and members of the Executive Committee and the Board of Managers is provided in **Figure 6.2-2**.

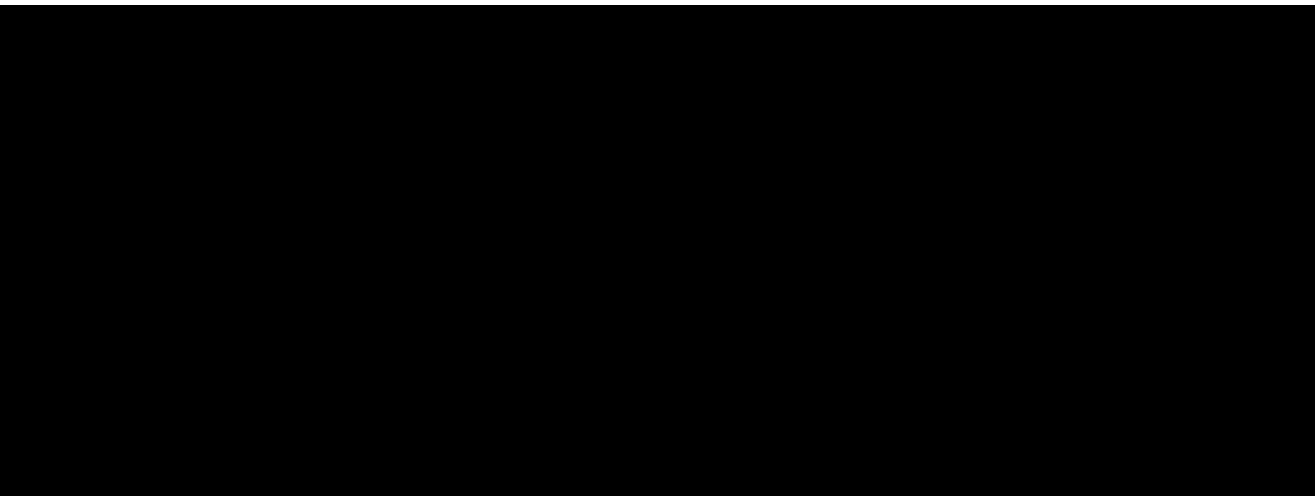
Biography highlights of managers, executives, officers, and directors are provided below. Additional detail, including resumes, is provided in **Section 2**.







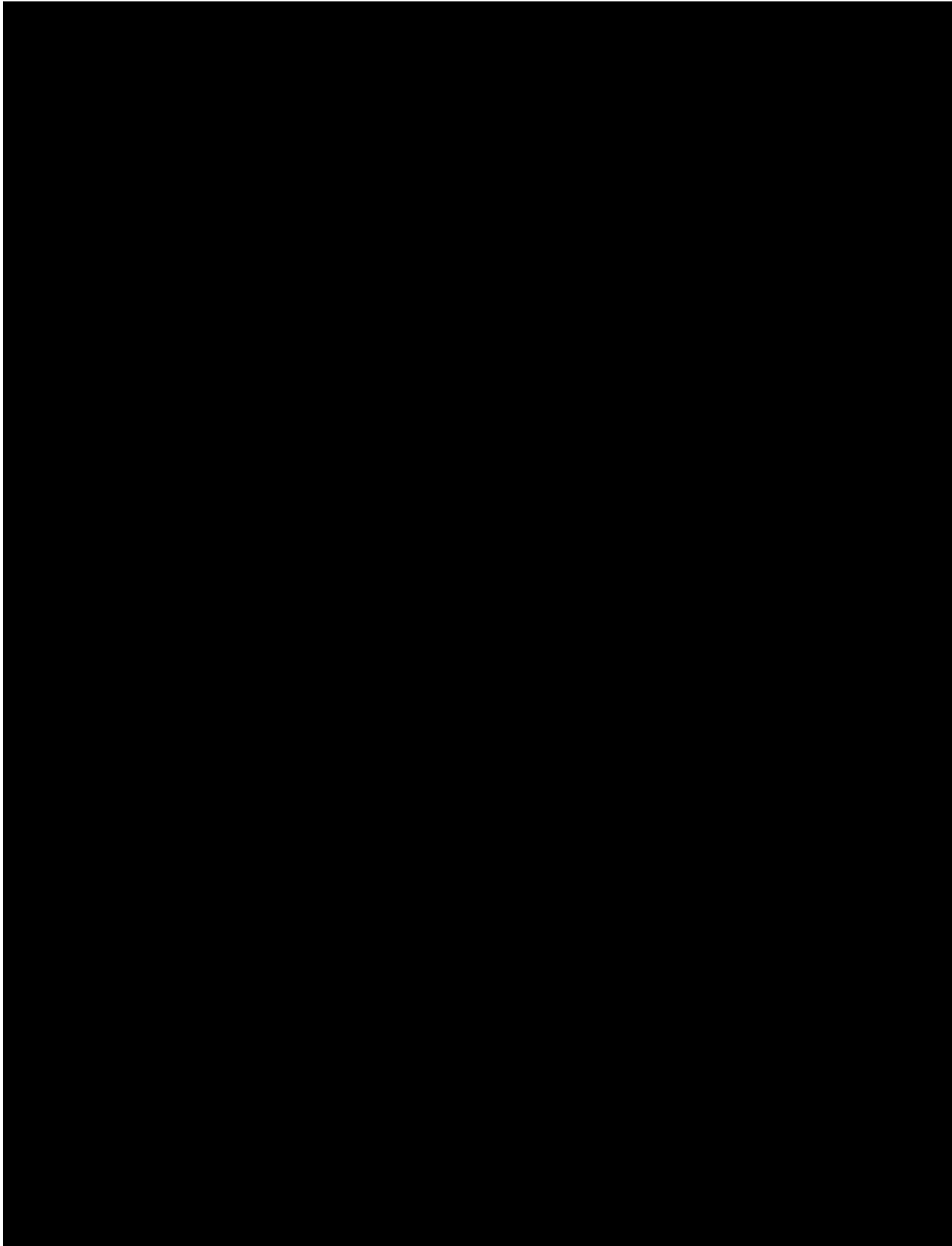
As counterparty to a proposed contract with NYSERDA, Vineyard Wind has the authority from its parent companies to submit this proposal for Liberty Wind, as evidenced by the letters of authorization provided as **Attachments 6.1-1** and **6.1-2**.

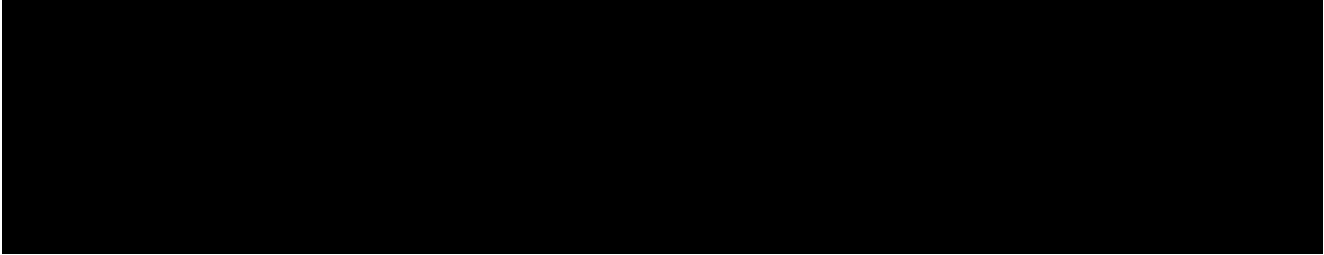
ANBARIC DEVELOPMENT PARTNERS LLC





ADP has a five-person Board of Directors 
 In addition to carrying out its normal fiduciary responsibility, ADP's Board of Directors must approve all development and capital investments. ADP's Management Committee is responsible for the day-to-day operations of the company, including seeking budget approval from the Board of Directors. An organizational chart showing ADP's Board of Directors and Management Committee is provided in **Figure 6.2-3**.

Biography highlights of managers, executives, officers, and directors are provided below. Additional detail, including resumes, is provided in **Section 2**.



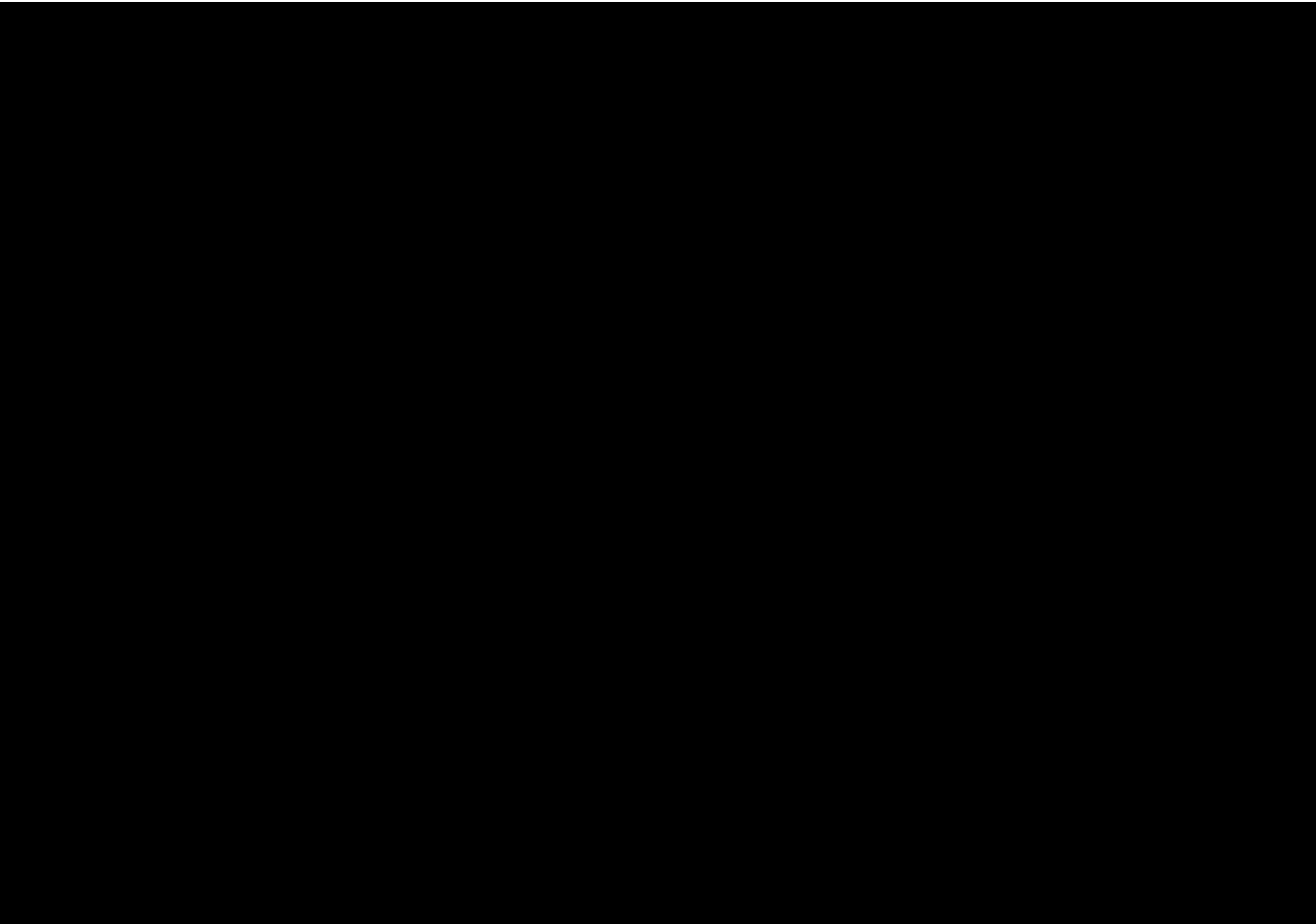


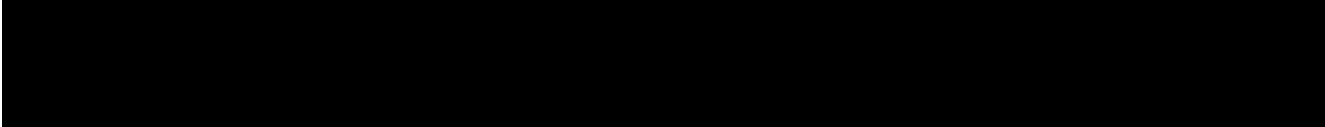
SHAREHOLDERS, SUBSIDIARIES, AND PARTNERS SUPPORTING THE PROJECT

The information presented below highlights Vineyard Wind’s parent companies’   financing capabilities, and the roles and responsibilities of affiliates in Liberty Wind.

COPENHAGEN INFRASTRUCTURE PARTNERS

CIP is a fund management company specializing in investments in the energy infrastructure sector. CIP was established in October 2012 by four senior executives from the energy industry and PensionDanmark, one of the largest labor market pension funds in Denmark. Since its establishment, CIP has raised four infrastructure funds to support renewable technologies with total equity of \$7.5 billion provided by more than 40 Danish and international investors. CIP holds a 50% equity interest in Vineyard Wind through the funds CI II and CI III. **Figure 6.2-4** illustrates CIP’s business entity structure and respective interests in Vineyard Wind.





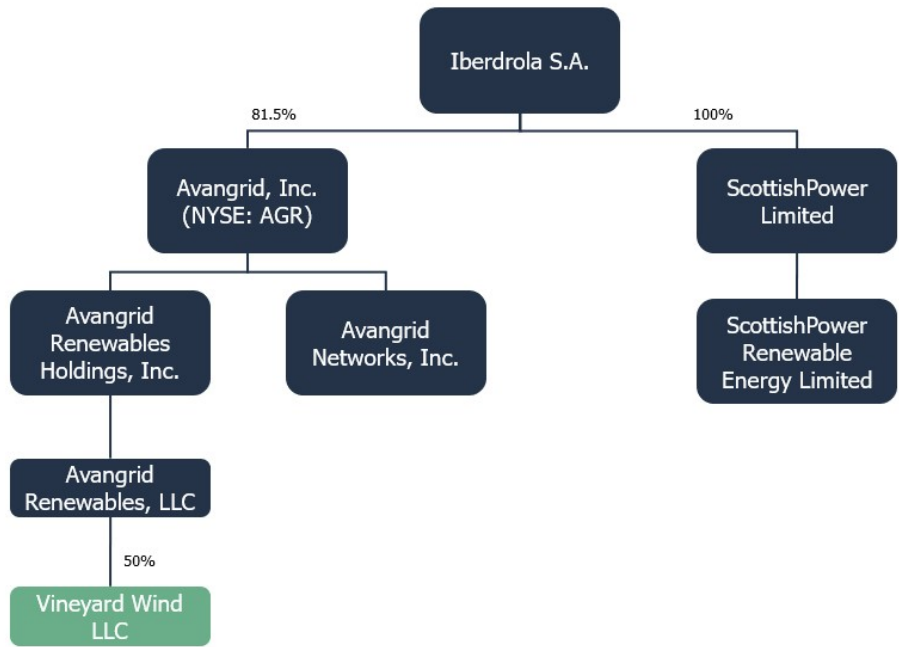
To-date CIP has secured financing for 12 projects, including the following offshore wind projects:

- **Veja Mate, Germany** – 402 MW project completed in May 2017;
- **Dolwin 3, Germany** – 900 MW HVDC offshore wind transmission system completed in September 2018; and
- **Beatrice, United Kingdom** – 588 MW project, first power was exported in July 2018.

AVANGRID RENEWABLES

Avangrid Renewables is the third largest renewable energy developer in the US and has more than \$10 billion worth of operating assets and 7,100 MW of owned and controlled generation capacity, primarily wind and solar facilities, in 22 states across the US. **Figure 6.2-5** illustrates Avangrid Renewables’ corporate structure, including its ultimate parent company, Iberdrola, in addition to the affiliates who will support Avangrid Renewables in the development and construction of the Project.

Figure 6.2-5 Avangrid’s Corporate Structure (including Vineyard Wind)



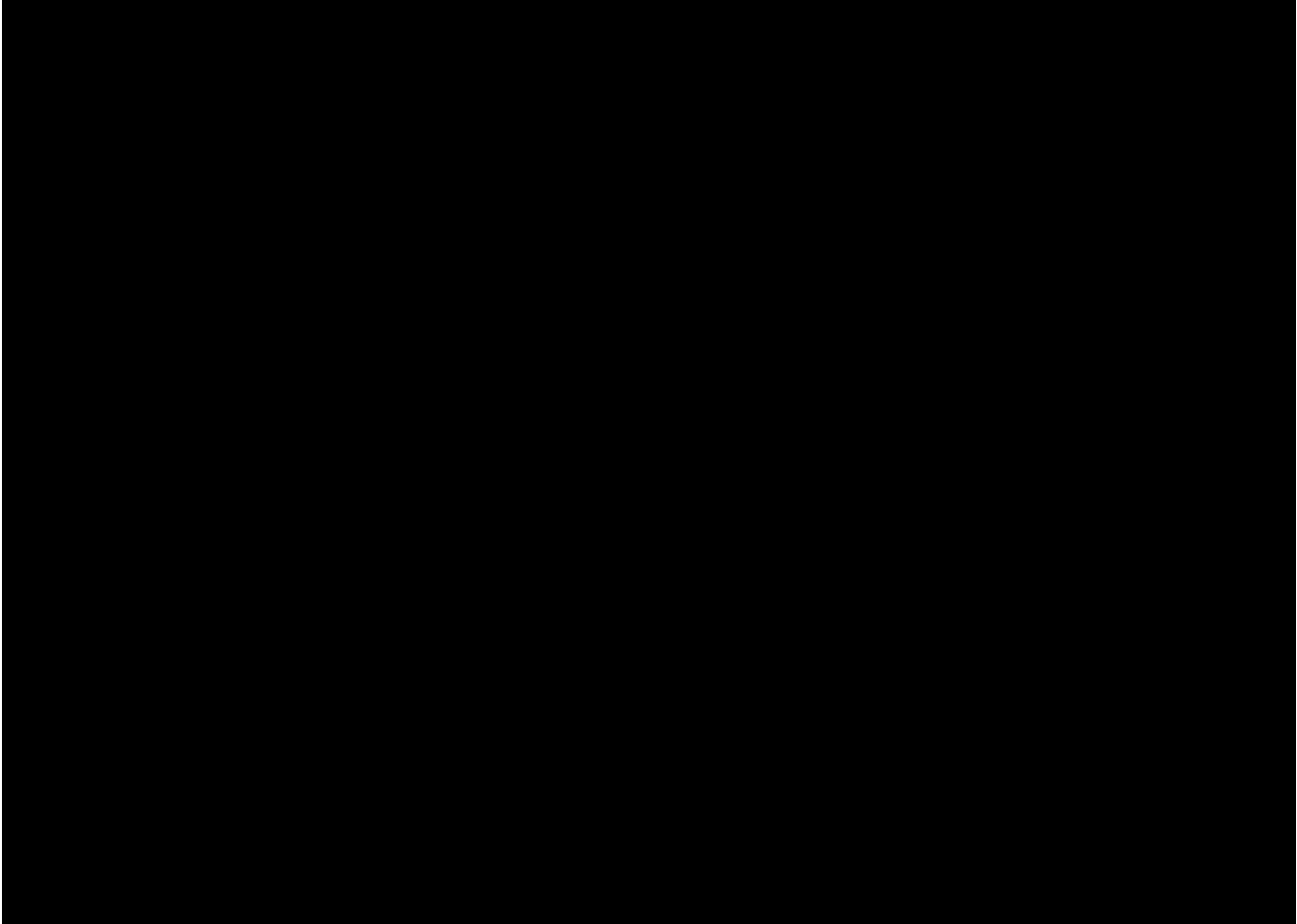
AVANGRID INC.

Avangrid Renewables is owned by Avangrid Inc. (Avangrid), which has more than \$31 billion in assets and operations in 24 states, and access to public debt and equity markets through its listing on the New York Stock Exchange (NYSE: AGR).

Avangrid is 81.5% owned by Iberdrola, one of the world’s largest wind developers, with more than 15,000 MW of installed wind capacity, and 29,592 MW of renewable energy capacity. Vineyard Wind will also be supported by personnel from Iberdrola’s subsidiary ScottishPower Renewables, which is responsible for Iberdrola’s offshore wind projects outside of the US and has considerable experience in the development, construction, and operation of offshore wind farms.

ANBARIC DEVELOPMENT PARTNERS

 **Figure 6.2-6** illustrates ADP’s corporate structure. 



-
- 6.3 *Provide a description of the financing plan for the Project, including construction and term financing. The financing plan should address the following:*
- a. *Who will finance the Project (or are being considered to finance the Project) and the related financing mechanism or mechanisms that will be used (i.e., convertible debenture, equity or other) including repayment schedules and conversion features*
-

FINANCING PLAN FOR THE PROJECT

The Project's pre-construction phase will be financed 100% through parent company and investor equity.

[REDACTED]

[REDACTED] It is useful to review the Project's financing process across the different project phases: pre-construction, construction, and operations.

Pre-construction: This phase would focus on preparing for the Project's construction including design, permitting, execution of P&SA(s) and [REDACTED], arrangement of construction supply agreements, financing arrangements, etc. [REDACTED]

[REDACTED]

The pre-construction phase typically ends at financial close, when agreements formalizing the Project's financing are executed by the parties, [REDACTED]

Construction Phase: The Project's construction phase commences with a Notice to Proceed to all parties involved. [REDACTED]

[REDACTED]

[REDACTED] The construction phase ends when the Project achieves commercial operation.

Operations Phase: The operations phase begins on the Project’s commercial operation date (COD). At COD, construction loans are “taken out” with permanent debt financing. This take-out was pre-arranged in the pre-construction phase, and is a condition imposed by construction lenders. Often times, the construction loan take-out is simply a conversion of construction loan balances into amortizing bank term loans.

Capital Structure: In project finance, capital structure is most typically expressed in terms of a coverage ratio called debt-service coverage ratio (DSCR) rather than in terms of leverage ratio (i.e., debt-to-capital). DSCR is defined as cash flow available for debt service divided by interest plus principle payments. The amortizing loans are sculpted based on a forecast of project cash flows to provide a stable DSCR over the life of the loans. A project typically targets a DSCR that corresponds to a particular credit rating [REDACTED]

Alternative sources of capital: The description above covers a fairly typical approach to capital structure. There are, however, a very large number of different sources of capital and structures that could be employed, particularly in the operations phase of the Project. The parent company affiliates are considering all of these potential sources for financing the first 800 MW project. Below is a brief description of the most common alternative capital sources.

Tax Equity: Under current law, production and investment tax credits (PTC and ITC, respectively) for wind are phasing out [REDACTED]

[REDACTED] Tax equity financing exchanges an upfront payment to a project (i.e., a source of financing) in exchange for the allocation of the PTC or ITC, a percentage of the tax income, and some cash. Tax equity funds at COD and is pre-arranged as part of the construction finance take-out. [REDACTED]

Project bonds: Project bonds are a non-bank provided debt product. The largest providers of these products are typically insurance companies but include many of the same investors that buy utility bonds. This market can be accessed either through a private-style execution (Section 4(2)) or public-style (Rule 144A) execution. This form of capital is increasingly used for financing European offshore wind projects. These bonds would typically be used to refinance bank term loans that are the “permanent” financing put in place at COD. Bond investors tend to have an appetite for longer tenors (i.e., investment periods) than banks and therefore the use of bonds can reduce refinancing risk over the life of a project.

Mezzanine financing: This is a “catch-all” for financing instruments that would sit between senior debt and parent company equity in the capital structure and typically take the form of subordinated debt or preferred equity. These instruments are normally used to refinance a portion of the “permanent” bank term loans put in place at COD. Pension funds and infrastructure focused investment funds are often the source of capital for these financing instruments.

b. The Project's existing initial financial structure and projected financial structure

Vineyard Wind and ADP each have no debt and their development activities in connection with the Project, including lease and property rights acquisition, physical research, bidding, permitting, and contracting will be funded [REDACTED]

[REDACTED]

c. Expected sources of debt and equity financing

Vineyard Wind is considering multiple sources of debt and equity financing. [REDACTED]

[REDACTED]

d. Describe how any such agreements would differ, contingency on NYSERDA's selecting either the Fixed OREC or Index OREC form of pricing

e. Estimated construction costs


Construction costs for the Project are estimated to be [REDACTED] and are expected to be financed by [REDACTED]

[REDACTED]

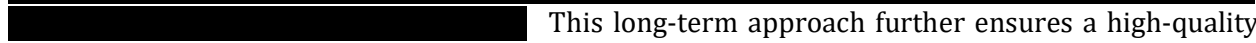
[REDACTED] See Table 6.4-1, Table 6.4-2 and Table 6.4-3 below.

f. The projected capital structure

g. Describe any agreements, both pre and post Commercial Operation Date, entered into with respect to equity ownership in the proposed Project and any other financing arrangement

In each phase of the Project, equity will be provided by CI II, CI III, and Avangrid 

The considerable financial resources available to these organizations are described in response to **Question 6.5**.

 This long-term approach further ensures a high-quality Project that will provide excellent value to New York ratepayers.

- 6.4. *Provide documentation illustrating the experience of Proposer in securing financing for projects of similar size and technology. For each project previously financed provide the following information:*
- a. Project name and location*
 - b. Project type and size*
 - c. Date of construction and permanent financing*
 - d. Form of debt and equity financing*
 - e. Current status of the project*
-

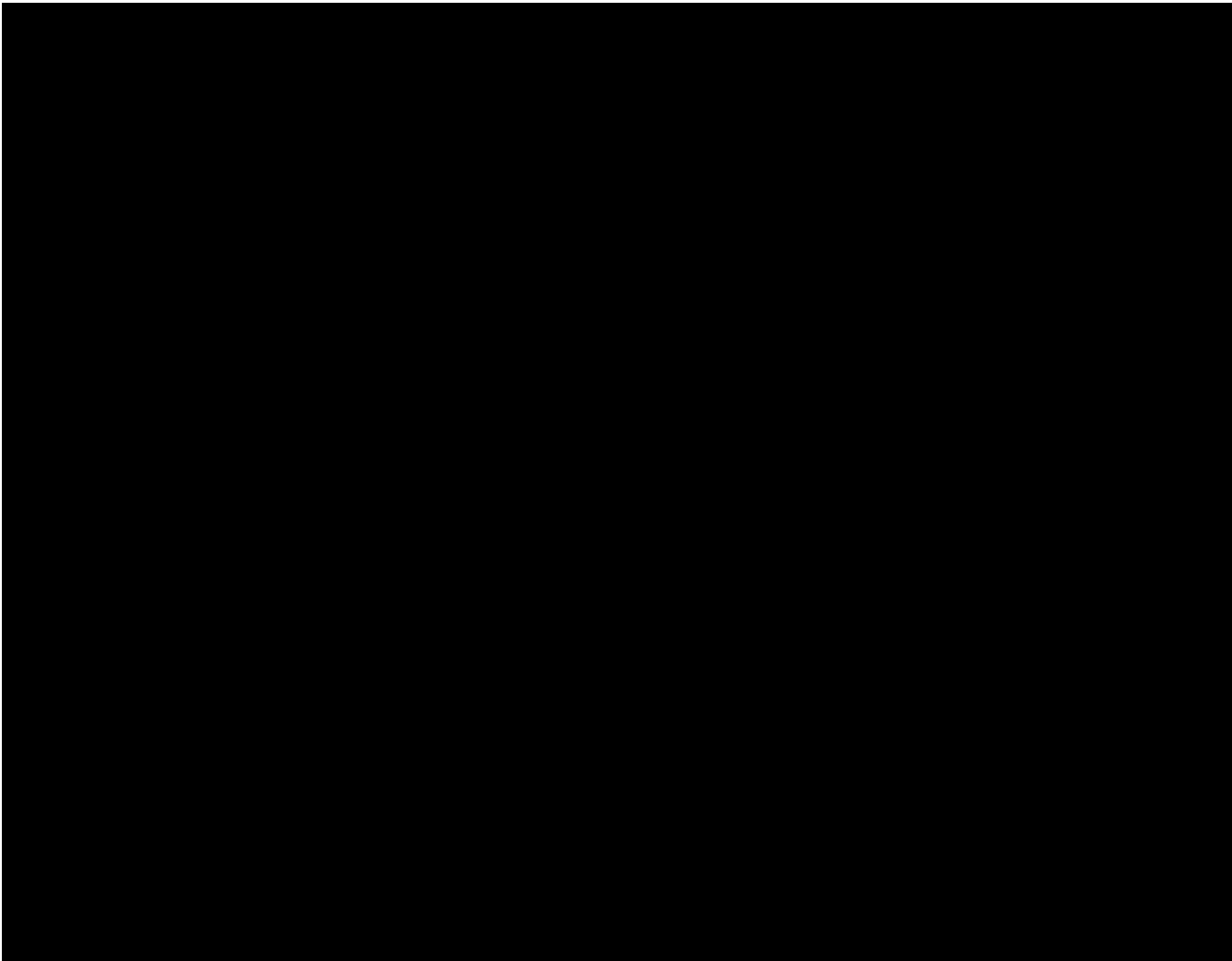
FINANCING EXPERIENCE

Vineyard Wind's parent companies and affiliates have significant experience financing offshore wind projects of similar size and technology, as detailed below.

COPENHAGEN INFRASTRUCTURE PARTNERS

The CIP team has a unique combination of hands-on experience and execution skills covering all aspects of energy infrastructure investments from sourcing, structuring, financing, and negotiations to project development, construction, and operations management, as well as general management.

Table 6.4-1 provides a list of selected projects financed by way of CIP-managed funds that are either operating or under construction.

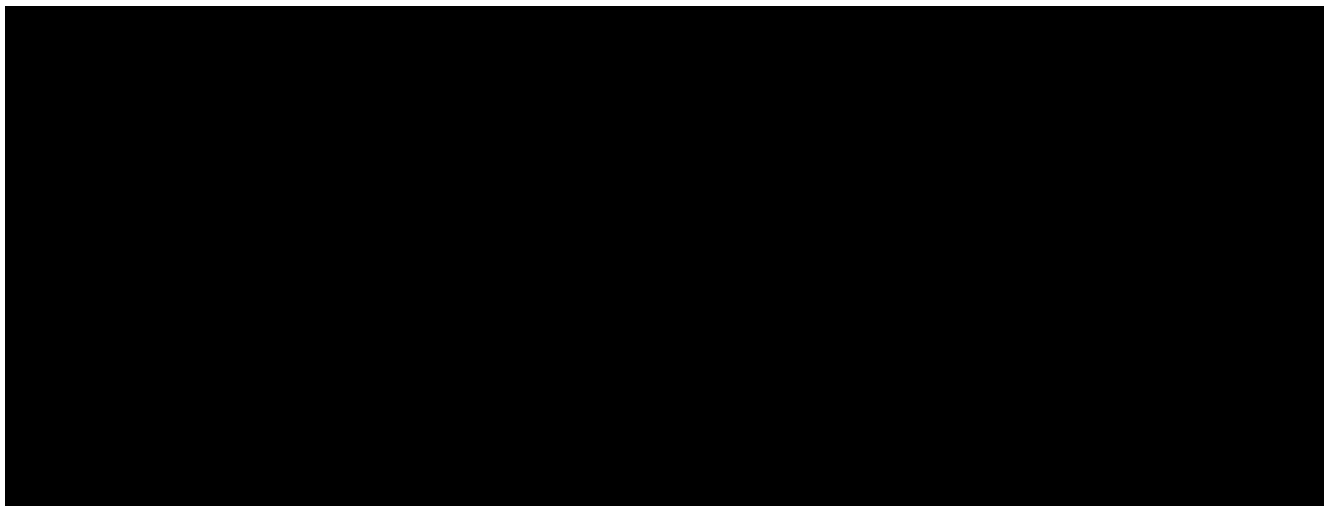


AVANGRID RENEWABLES


Substantially all Avangrid Renewables' wind and solar projects are unencumbered by debt, having been funded by equity contributions from its parent company. Between 2006 and 2008, Avangrid Renewables also raised tax equity financing totaling \$1.6 billion and tax equity of \$0.2 billion was raised in 2018.

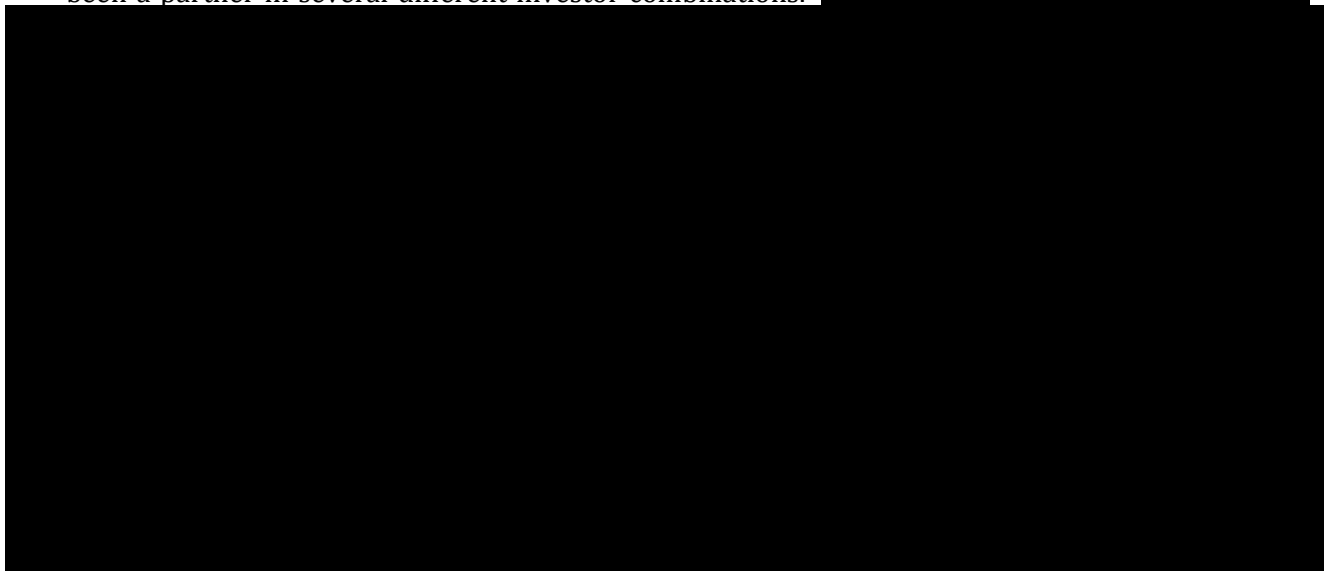
IBERDROLA

Avangrid Renewable's ultimate parent company, Iberdrola, has committed funding for the construction of more than \$6 billion of offshore wind projects in Europe. **Table 6.4-2** below lists selected Iberdrola projects that are either operating or under construction.




ANBARIC LLC

Anbaric is an experienced developer of transmission projects in New York and New Jersey and has been a partner in several different investor combinations. 



6.5 Provide evidence that Proposer has the financial resources and financial strength to complete and operate the Project as planned

FINANCIAL STRENGTH OF THE PROPOSERS

Vineyard Wind parent companies and ADP's investors are financially-sound organizations, providing the resources and financial strength to complete and operate the Project as planned. The strong financial condition of Vineyard Wind's parent companies  is evidenced by its financial reports and available credit ratings, as set forth below and in response to **Question 6.7**.

COPENHAGEN INFRASTRUCTURE PARTNERS

CIP is a fund management company that currently has four funds and more than \$7.5 billion under management. The company has the ability to deploy funds in line with its investment governance processes. Credit ratings are not provided for infrastructure funds and are therefore not available. CIP fund investors are large institutional investors, such as large pension funds (e.g., PensionDanmark, PFA, European Investment Bank, Lærernes [teachers] Pension, and Oslo Pensjonforsikring). CIP funds invested in Vineyard Wind are from CI II and CI III, which are joint funds of more than \$5.5 billion. The commitments made by the limited partners to CI II and CI III are governed by limited partner agreements, which stipulate that a limited partner may not withdraw its commitment. Each of the limited partners' commitments has been verified by the leading Danish law firm, Bruun Hjejle.

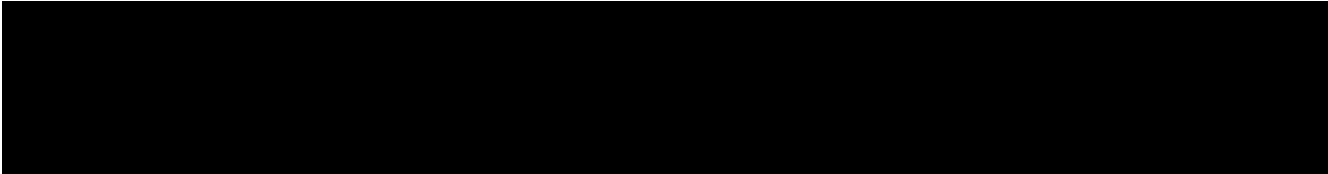
AVANGRID RENEWABLES

Avangrid Renewables is supported by its parent company Avangrid, a public company with an equity market capitalization of approximately \$15 billion. It has credit ratings of BBB+ / Baa1 / BBB+ from S&P and Moody's and Fitch, respectively. Avangrid has the ability to raise equity capital from its majority owner, Iberdrola, or from US public equity markets. Avangrid also has access to the investment grade debt capital markets and, in November 2017, raised \$600 million through the issuance of a seven-year green bond. In addition, Avangrid's utilities access the debt capital markets directly and have over \$5.2 billion of long-term debt outstanding. The company also has a committed \$2.5 billion revolving credit facility and an active \$2 billion commercial paper program.

Iberdrola is listed on the stock exchanges in Madrid (Ibex-35), Barcelona, Bilbao, and Valencia. In New York, the company is listed in the form of an American Depositary Receipt (ADR). At the end of September 2018, Iberdrola had a market capitalization of \$48 billion with 48,985 MW of installed generation capacity. Of this capacity, 29,592 MW is renewable resources. More than half (i.e., 16,000 MW) of Iberdrola's renewable energy capacity is wind; the remainder is hydropower and other renewable technologies.

6.6 Describe the role of the Federal Production Tax Credit or Investment Tax Credit (or other incentives) on the financing of the Project, including presumed qualification year and percentage. The Proposal may not be contingent on receipt of the Production Tax Credit or Investment Tax Credit.

ROLE OF TAX INCENTIVES



6.7 Provide complete copies of the most recent audited financial statement and annual report for each Proposer for each of the past three years; including affiliates of Proposer (if audited statements are not available, reviewed or compiled statements are to be provided). Also, provide the credit ratings from Standard & Poor’s and Moody’s (the senior unsecured long-term debt rating or if not available, the corporate rating) of Proposer and any affiliates and partners.

FINANCIAL REPORTS OF PROPOSERS

VINEYARD WIND

As a private company, Vineyard Wind does not have any credit ratings.

COPENHAGEN INFRASTRUCTURE PARTNERS

Credit ratings are not provided for infrastructure funds and are therefore not available for CIP-managed funds. Annual reports for CIP’s affiliates are found in **Attachment 6.7-1** (CI II Annual Report 2017), **Attachment 6.7-2** (CI-II US AIV Non-QFPF Annual Report 2017), **Attachment 6.7-3** (CI-II US AIV QFPF Annual Report 2017), and **Attachment 6.7-4** (CI-III Annual Report 2016-2017).

AVANGRID RENEWABLES

Avangrid Renewables’ parent company, Avangrid, is a NYSE traded entity and its credit rating as of June 2018, is provided in **Table 6.7-1** below. Avangrid Renewables’ audited annual accounts are provided in **Attachment 6.7-5** (2017), **Attachment 6.7-6** (2016), and **Attachment 6.7-7** (2015).

Table 6.7-1 Credit Ratings for Avangrid Inc. (January 2019)

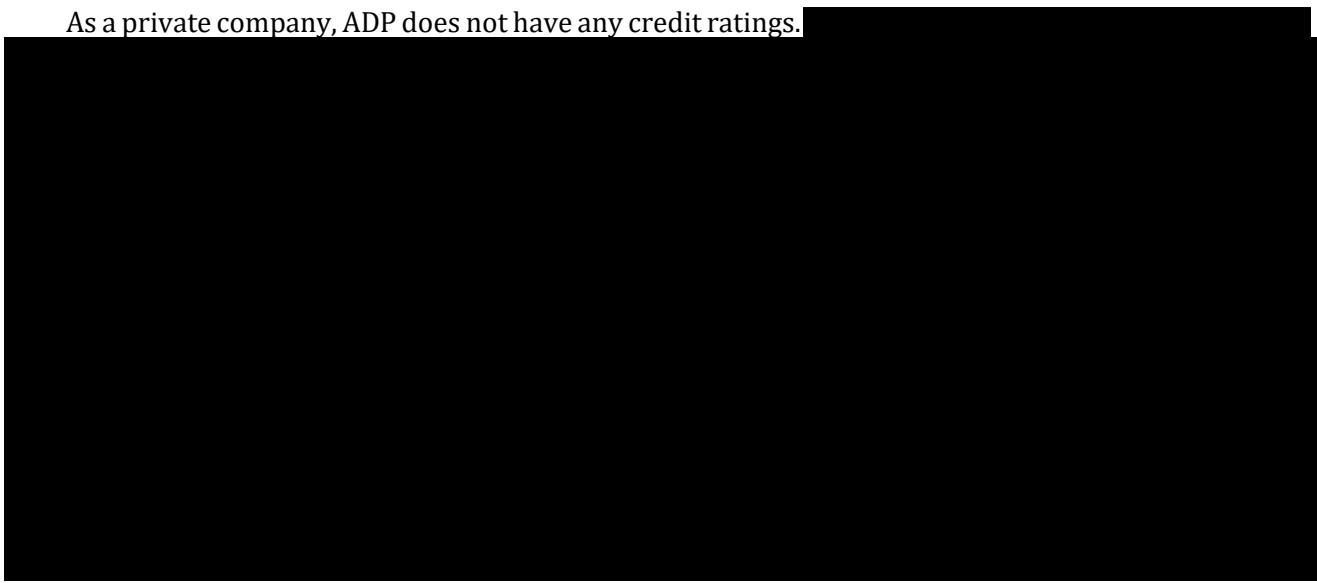
Sponsor	Standard & Poor	Moody’s
Avangrid Inc.	BBB+ (Stable)	Baa1 (Stable)

Avangrid Renewables ultimate parent company, Iberdrola, is listed on the stock exchanges in Madrid (Ibex-35), Barcelona, Bilbao, and Valencia. In New York, the company is listed in the form of an ADR.

Annual reports for Iberdrola can be found in **Attachment 6.7-8** (2017), **Attachment 6.7-9** (2016), and **Attachment 6.7-10** (2015).

ANBARIC DEVELOPMENT PARTNERS

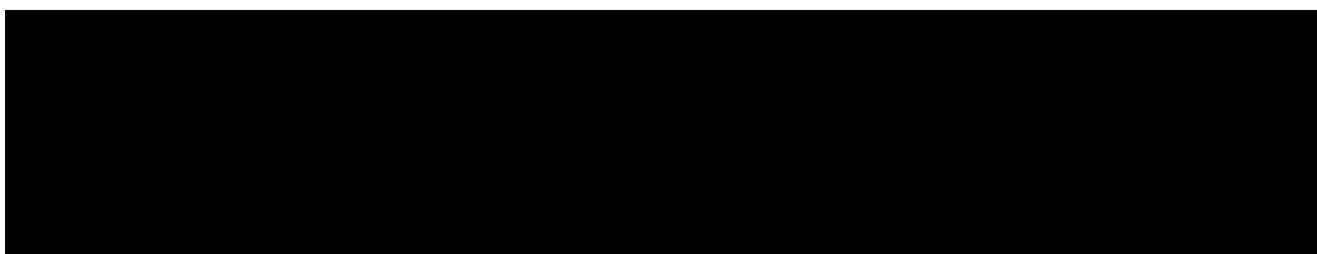
As a private company, ADP does not have any credit ratings.



6.8 List the board of directors, officers and trustees for the past three years and any persons who Proposer knows will become officers, board members or trustees

VINEYARD WIND OFFICERS AND BOARD MEMBERS

A list of Vineyard Wind's current officers and board members, and their year of appointment, are provided in response to **Question 2**.



Vineyard Wind has the ability to draw upon the considerable management resources of its shareholders in making any future board or officer appointments, however no such appointments are planned at this time.

ANBARIC DEVELOPMENT PARTNERS OFFICERS AND BOARD MEMBERS

ADP's board of directors and members of the management committee are provided in response to **Question 2**.

6.9 *Demonstrate Proposer's ability (and/or the ability of its credit support provider) to provide the required security, including its plan for doing so.*

ABILITY TO PROVIDE SECURITY

Vineyard Wind will provide the required security by way of parent guaranty, bank letters of credit, or cash-on-hand security provided by the parent companies in the form of equity capital, as referenced in **Attachment 6.1-1** and **Attachment 6.1-2**. The security value provided will be equal to \$15,000 per MW of the OREC P&SA's maximum value.

6.10 *Provide a description of any current or recent credit issues/ credit rating downgrade events regarding Proposer or affiliate entities raised by rating agencies, banks, or accounting firms.*

There are no recent credit issues or credit rating downgrade events regarding Vineyard Wind, ADP, or affiliate entities raised by rating agencies, banks, or accounting firms to report.

6.11 *Disclose any pending (currently or in the past three years) litigation or disputes related to projects planned, developed, owned or managed by Proposer or any of its affiliates in the United States, or related to any energy product sale agreement.*

Vineyard Wind is not currently involved in and has not been involved in over the last three years, any litigation or disputes related to projects developed, owned, or managed by Vineyard Wind.

To the best of CIP's knowledge as a fund management company, no current, past, or potential future material litigation, arbitration, or regulatory action, exists against any of CIP's investment professionals regarding professional matters, the General Partner, any partnership managed by CIP or an affiliate, CIP itself, or any affiliate of CIP.

Avangrid Renewables is part of a large corporate entity and, consequently, its affiliates are involved in litigation and disputes from time to time in the ordinary course of business. Information regarding any material litigation and disputes involving affiliates of Avangrid Renewables over the past three years can be found in the annual reports and related financial information referenced in the response to **Question 7** and in publicly filed periodic reports by Avangrid.

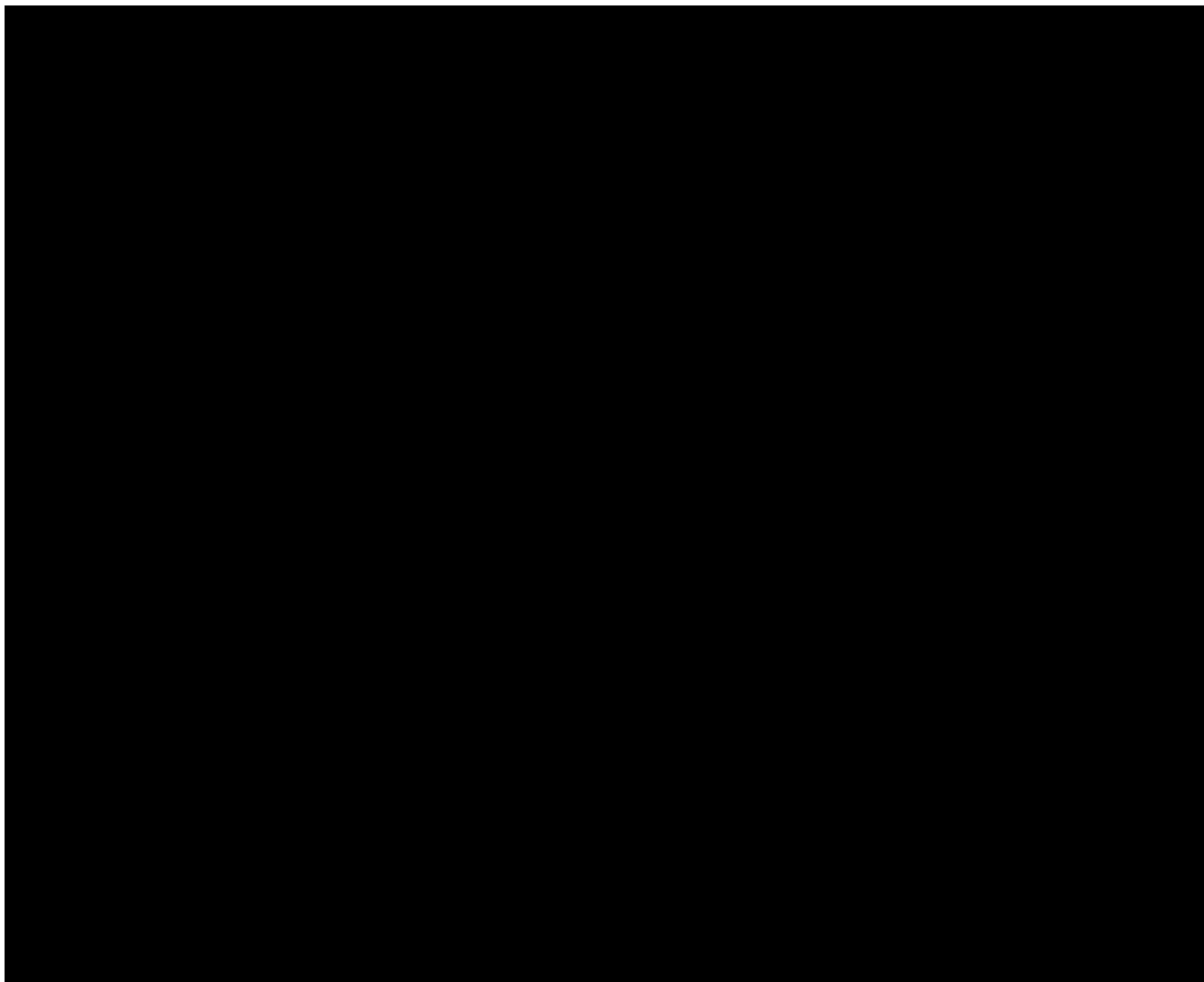
ADP is not currently involved in and has not been involved in over the last three years, any litigation or disputes related to projects developed, owned, or managed by ADP.

6.12 Provide the expected operating life of the proposed Project and the depreciation period for all substantial physical aspects of the offer, including generation facilities, generator lead lines to move power to the grid, and transmission system upgrades.

All major components of the Project have useful lives in excess of the term of the OREC P&SA.

6.13 List all of Proposers' affiliated entities and joint ventures transacting business in the energy sector.

Vineyard Wind's parent companies and their affiliates, including those described in response to **Question 2**, regularly conduct business in the energy sector. **Attachment 6.13-1** provides details for all of CI II affiliate companies; **Attachment 6.13-2** provides details for all of CI III affiliate companies; **Attachment 6.13-3** provides details for all of Avangrid Renewables affiliate companies; and **Attachment 6.13-4** provides details for all of Iberdrola's subsidiary companies.



6.14 Describe any litigation, disputes, claims or complaints, or events of default or other failure to satisfy contract obligations, or failure to deliver products, involving Proposer or an affiliate, and relating to the purchase or sale of energy, capacity or RECs or other electricity products.

Vineyard Wind, its parent companies, and affiliates have not been implicated in any material litigation, disputes, claims, complaints, events of default, or other material failure to satisfy contract obligations, or material failure to deliver products involving and relating to the purchase or sale of energy, capacity or RECs or other electricity products.

ADP, its owners, and affiliates have not been implicated in any material litigation, disputes, claims, complaints, events of default, or other material failure to satisfy contract obligations, or material failure to deliver products involving and relating to the purchase or sale of energy, capacity or RECs or other electricity products.

6.15 Confirm that Proposer, and the directors, employees and agents of Proposer and any affiliate of Proposer are not currently under investigation by any governmental agency and have not in the last four years been convicted or found liable for any act prohibited by State or Federal law in any jurisdiction involving conspiracy, collusion or other impropriety with respect to offering on any contract, or have been the subject of any debarment action (detail any exceptions).

Neither Vineyard Wind, nor any of its directors, employees, agents, or affiliates have been investigated by any governmental agency and have not in the last four years been convicted or found liable for any act prohibited by state or federal law in any jurisdiction involving conspiracy, collusion, or other impropriety with respect to offering on any contract and have not been the subject of any debarment action.

Neither CIP, its directors and employees, nor funds managed by CIP, have been investigated by any governmental agency and have not in the last four years been convicted or found liable for any act prohibited by state or federal law in any jurisdiction involving conspiracy, collusion or other impropriety with respect to offering on any contract, or have been the subject of any debarment action.

Avangrid Renewables is part of a large corporate entity and, consequently, the parent company and their directors, employees, agents, and respective affiliates, have been involved in regulatory investigations by governmental authorities from time to time in the ordinary course of business. Any such regulatory investigations will not have a material effect on that parent company's ability to perform on the contracts described in this proposal. The parent company, nor any of their directors, employees, agents, or affiliates have been convicted or found liable for any act prohibited by state or federal law in any jurisdiction involving conspiracy, collusion, or other impropriety with respect to offering on any contract, nor been the subject of any debarment action in the last four years.

Neither ADP, nor any of its directors, employees, agents, or affiliates have been investigated by any governmental agency and have not in the last four years been convicted or found liable for any act prohibited by state or federal law in any jurisdiction involving conspiracy, collusion, or other impropriety with respect to offering on any contract and have not been the subject of any debarment action.



LIBERTY WIND

SECTION 7 - INTERCONNECTION AND DELIVERABILITY


Proposal for New York State Energy Research and Development Authority in response to Request For Proposals for Purchase of Offshore Wind Renewable Energy Certificates

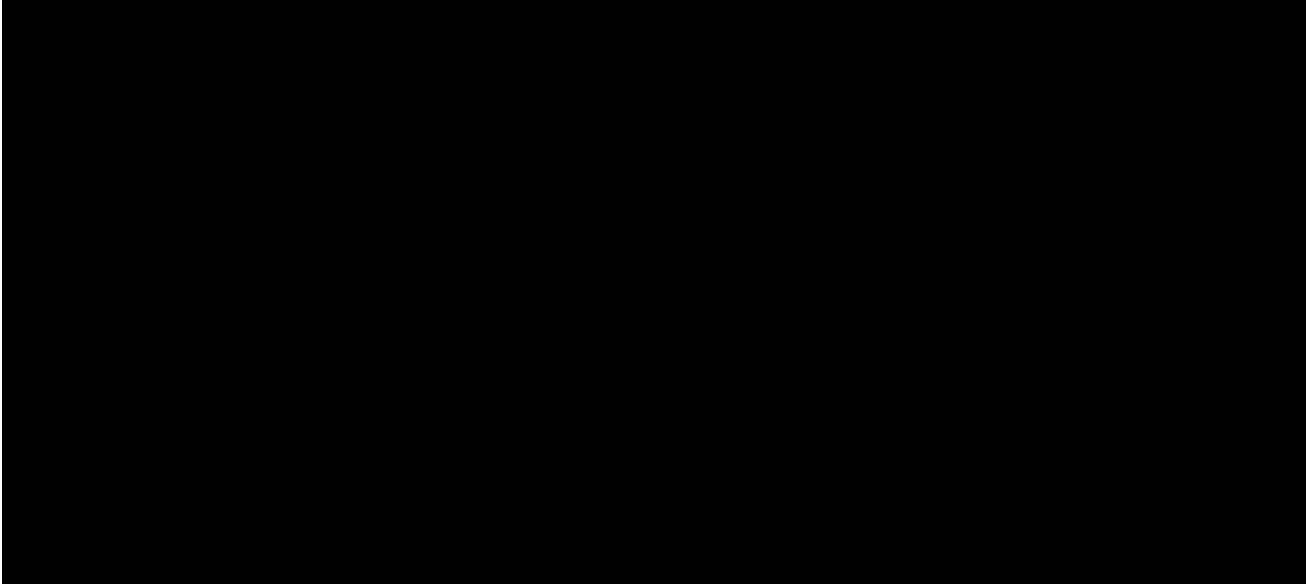



Photo: Veja Mate offshore wind farm


SECTION 7 INTERCONNECTION AND DELIVERABILITY

OVERVIEW

Vineyard Wind is proposing to construct Liberty Wind 



 Multiple interconnection solutions and scenarios have been evaluated in designing the most robust and cost-efficient interconnection solution for New York - including interconnecting the Project to the New England Control Area. Under such a scenario Liberty Wind would export the power through ISO New England (ISO-NE) over the New York-New England AC ties (“the ties”) to NYCA. This option was dismissed, following considerable internal analysis and consultations with market experts at NYISO and ISO-NE as the long-term risks for **both** the developer and NYSERDA (and New Yorkers) under such an approach are *prohibitively high*. The generator would be exposed to substantial price and revenue risk on the ties, as the generator would have to transact as a price taker on the ties or otherwise risk stranding generation in New England and losing OREC revenue. For NYSERDA, there is no guarantee that a generator can successfully clear and export all of its production to NYCA over the ties, especially over a span of 20 years or more, which means New York would not receive the offshore wind energy it procured and New York ratepayers and residents would not realize the direct benefits of offshore wind.

For this reason, and many others discussed throughout the Proposal, Liberty Wind will interconnect directly to 



 Additional technical detail is provided in **Section 9**.

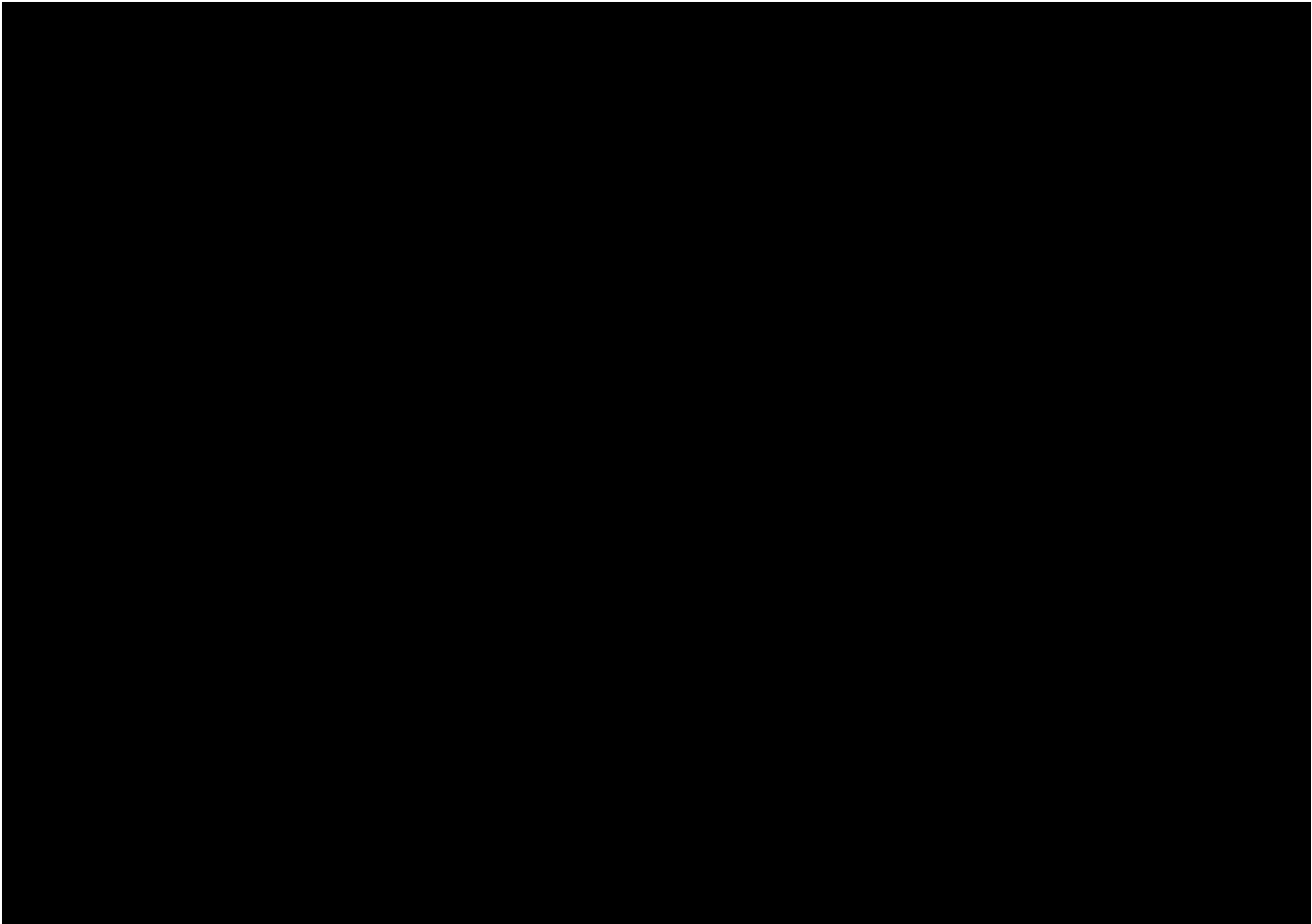
This section describes the interconnection and deliverability details [REDACTED]. A description of the interconnection requests and associated queue positions are described below and summarized in **Table 7.1-1**. As this section clearly shows, the Project will readily meet interconnection and deliverability requirements, and substantially benefits from Vineyard Wind’s offshore wind development expertise as well as Anbaric’s bulk power transmission experience and existing interconnection requests.

7.1 Provide documentation to show evidence of the interconnection request to NYISO or any neighboring control areas for Capacity Resource Interconnection Service (CRIS) or for Energy Resources Interconnection Service (ERIS), or similar interconnection standards in neighboring control areas. For Proposals where capacity is to be delivered to the New York Control Area (NYCA), Proposers should describe any required transmission system upgrades and provide an estimate of the required transmission system upgrade costs under NYISO CRIS to meet deliverability requirements in NYISO. Evidence that Proposer has a pending, valid interconnection request is sufficient. Describe the status of any planned interconnection to the grid. Any interconnection studies undertaken by the applicable control area or third parties on behalf of Proposer must be provided.

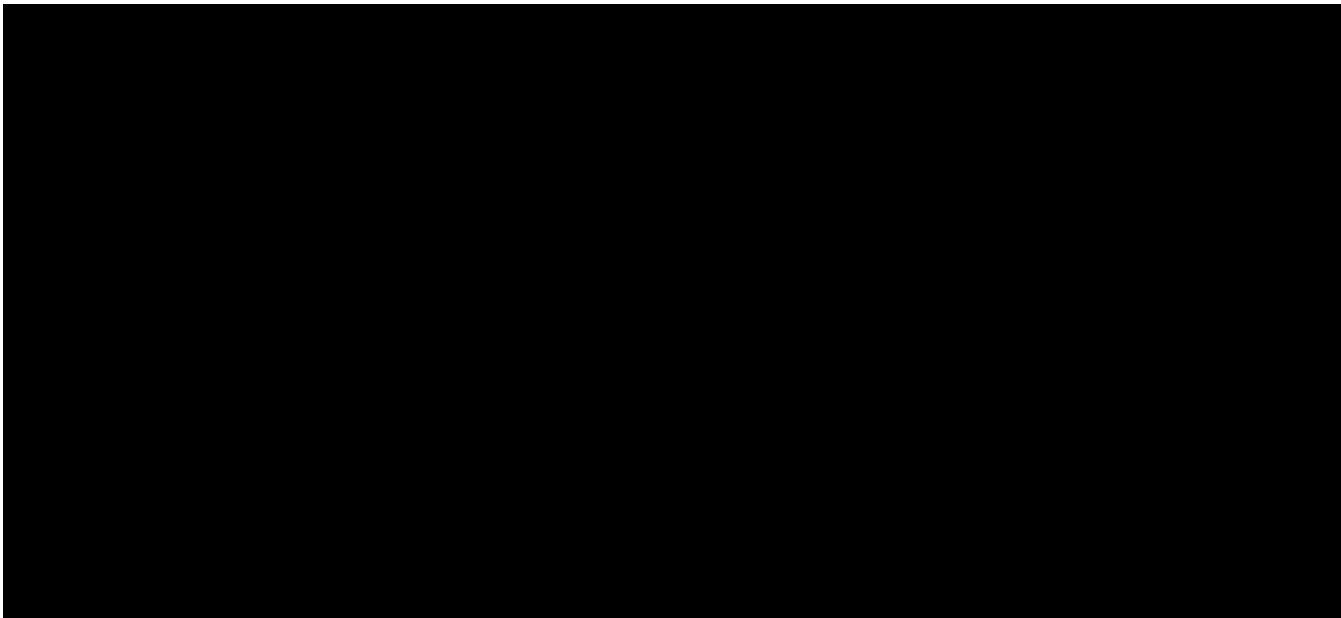
NYISO INTERCONNECTION REQUESTS

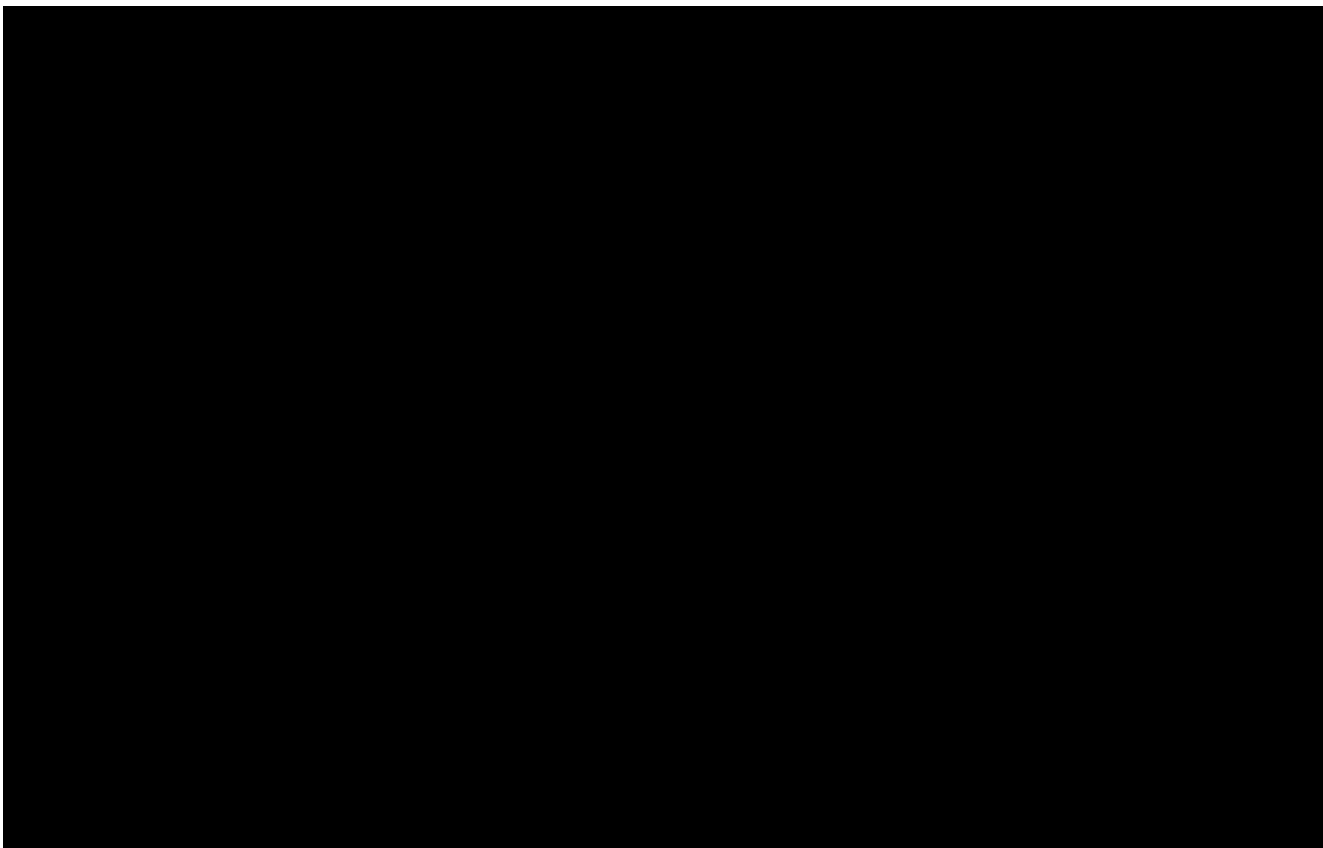
The Project will deliver [REDACTED] of offshore wind energy and capacity via pending, valid Large Facility Interconnection Requests (LFIR) with NYISO. [REDACTED]

[REDACTED]

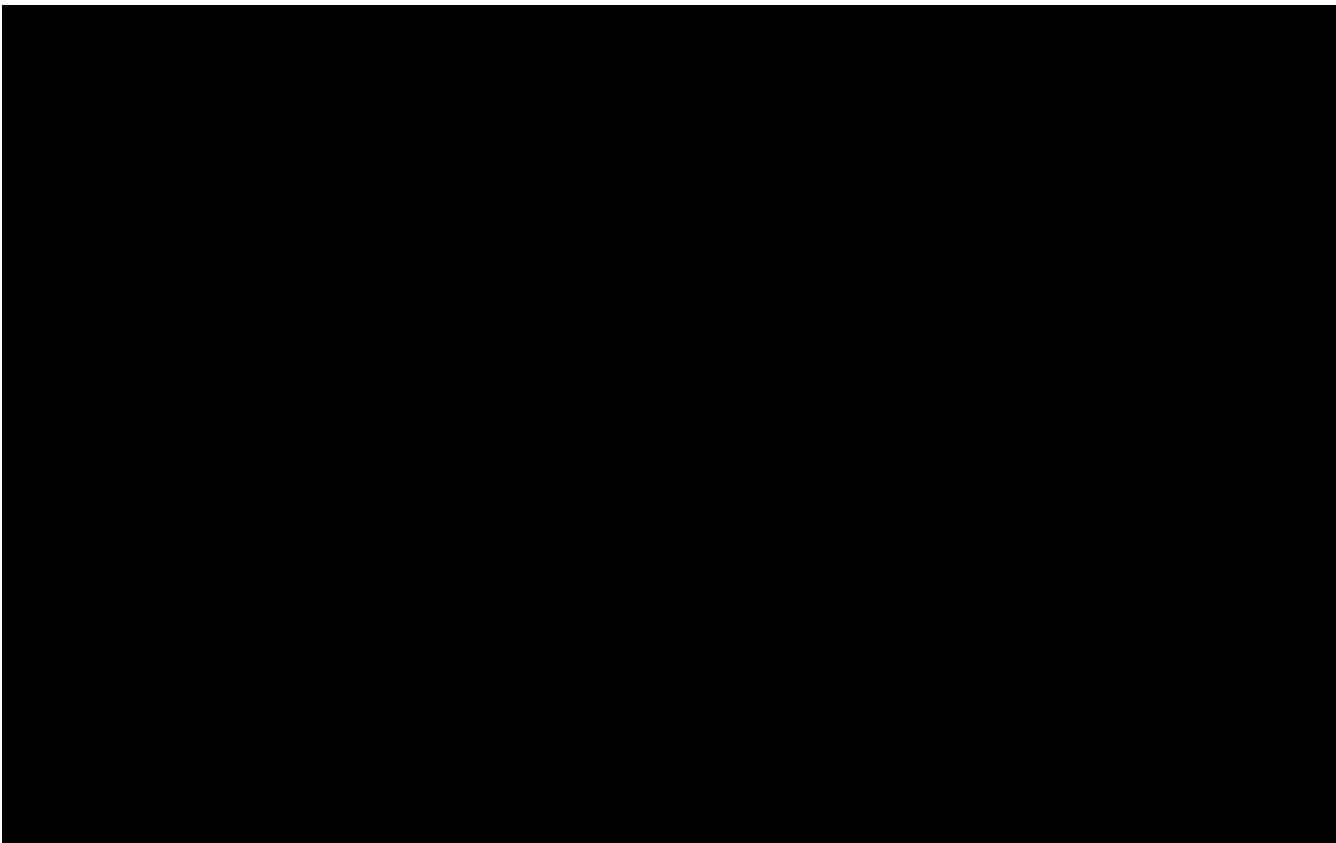


Other large substations in New York were considered as potential POIs [REDACTED] based on their location within the [REDACTED] grid, accessibility through a viable and constructible transmission route, and ability to deliver large-scale offshore wind power. [REDACTED]





Utilization of Interconnection Requests for the Project

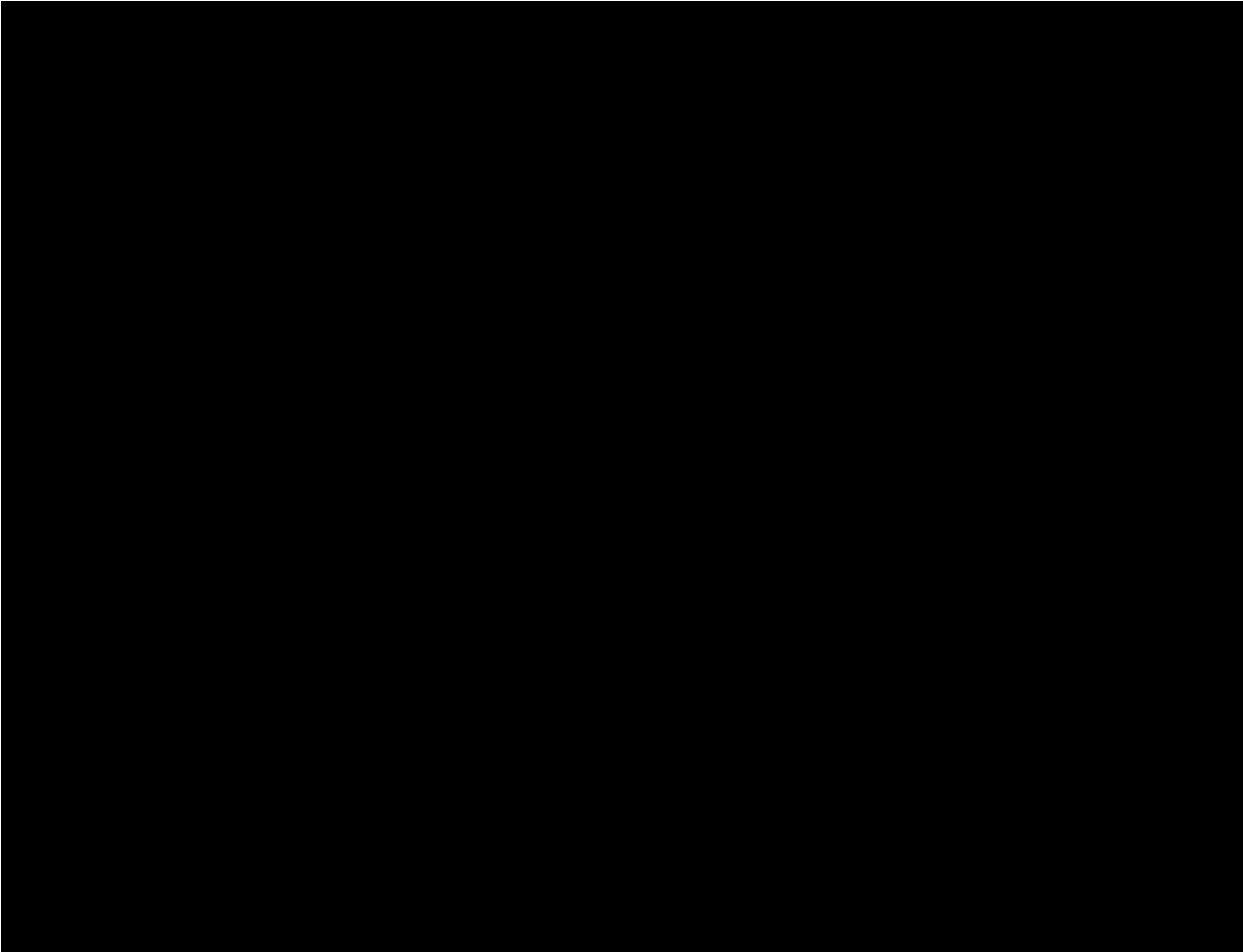


INTERCONNECTION STUDIES

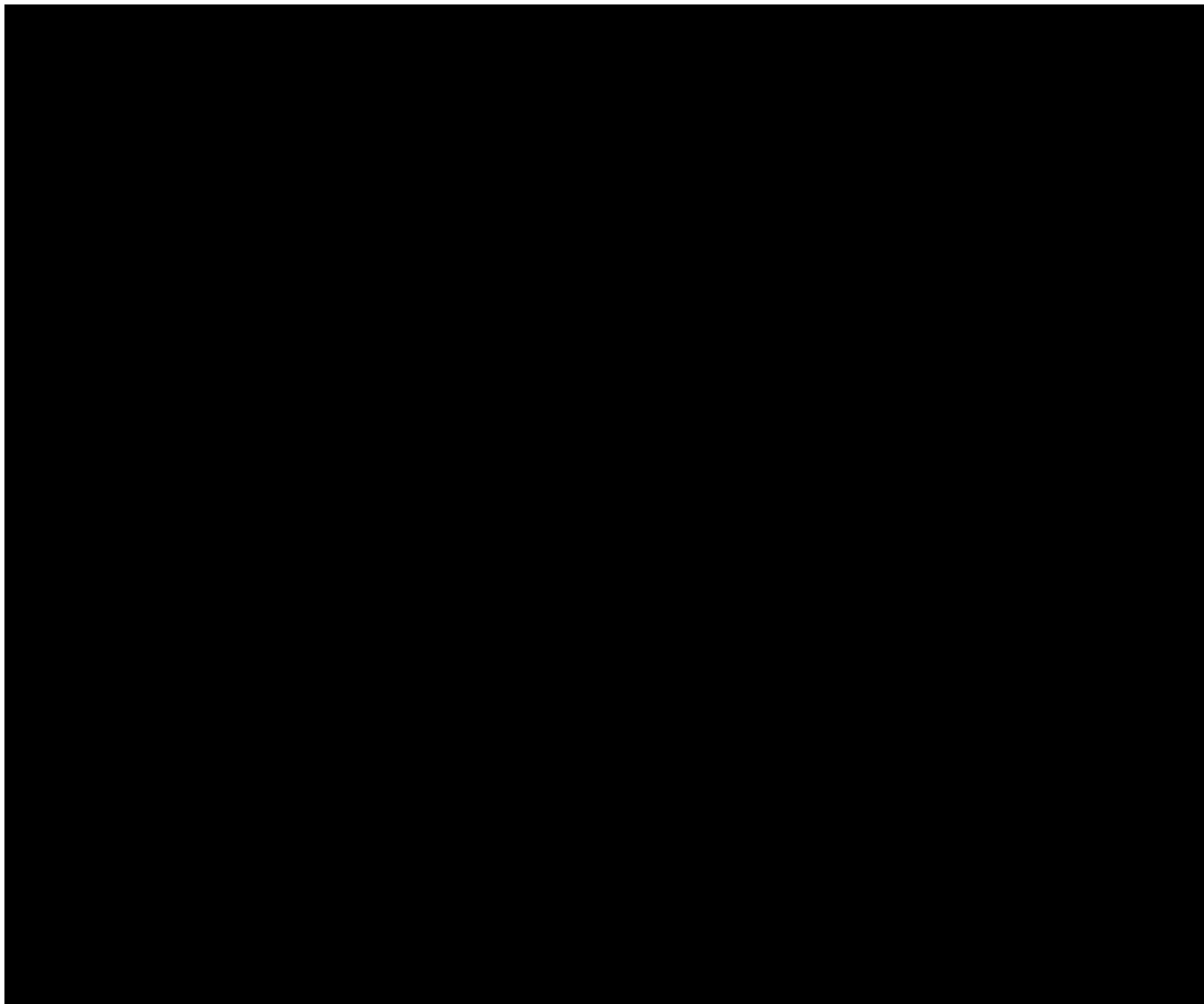
Vineyard Wind commissioned an interconnection study to evaluate the Project [REDACTED]
[REDACTED]
[REDACTED]
[REDACTED] A copy of the study is included as **Attachment 7.1-8** and its conclusions regarding anticipated system upgrades and costs are detailed below. [REDACTED]
[REDACTED]
[REDACTED]

7.2 Provide a copy of an electrical one-line diagram showing the interconnection facilities and the relevant facilities of the transmission provider.

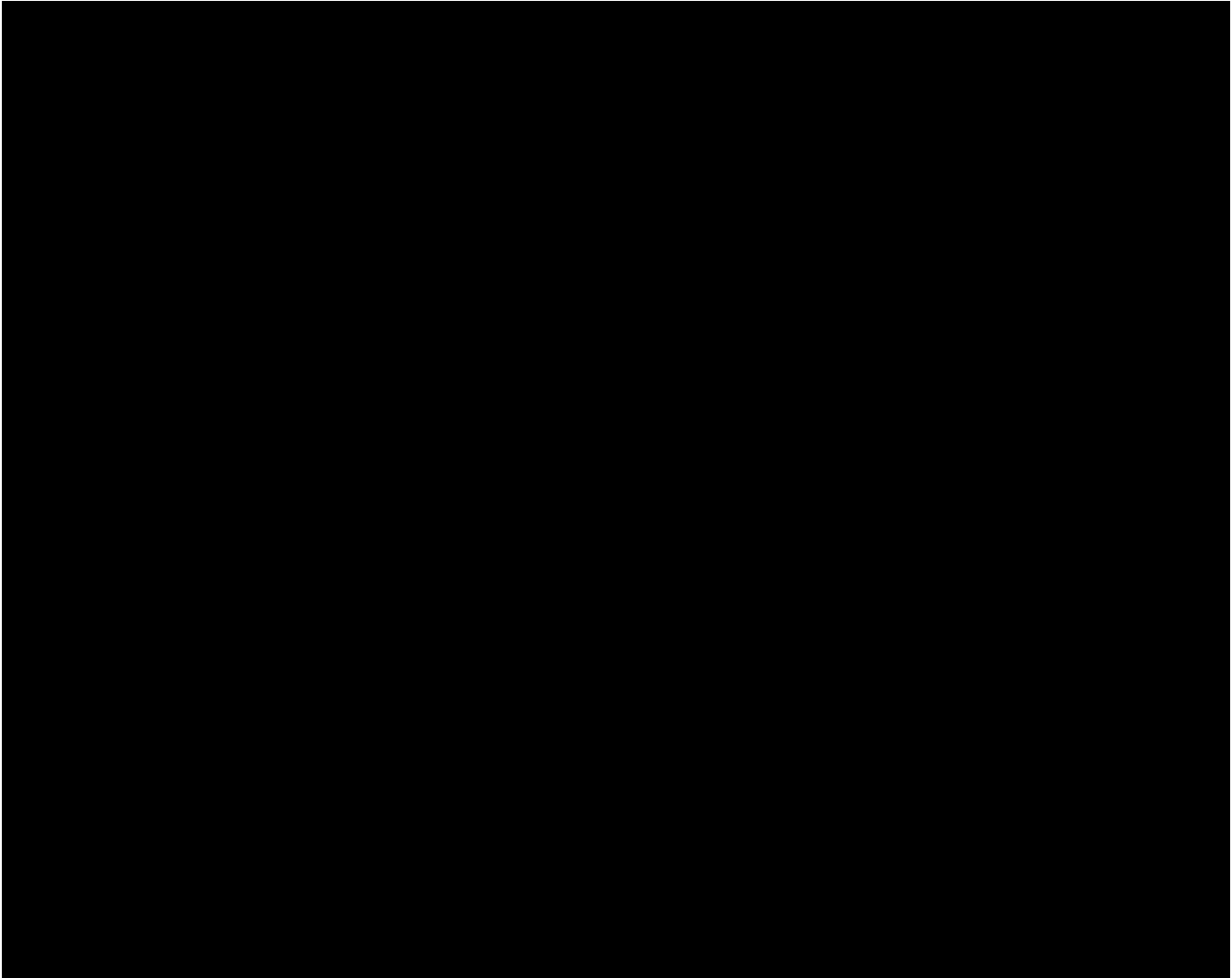
The electrical one-line diagram showing the interconnection and relevant facilities of the transmission provider area for the Project [REDACTED] is shown in **Figure 7.2-1**.



The electrical one-line diagram showing the interconnection and relevant facilities of the transmission provider area for Project [REDACTED] is shown in **Figure 7.2-2**.



The electrical one-line diagram showing the interconnection facilities and relevant facilities of the transmission provider area for Project Three [REDACTED] is shown in **Figure 7.2-3**.

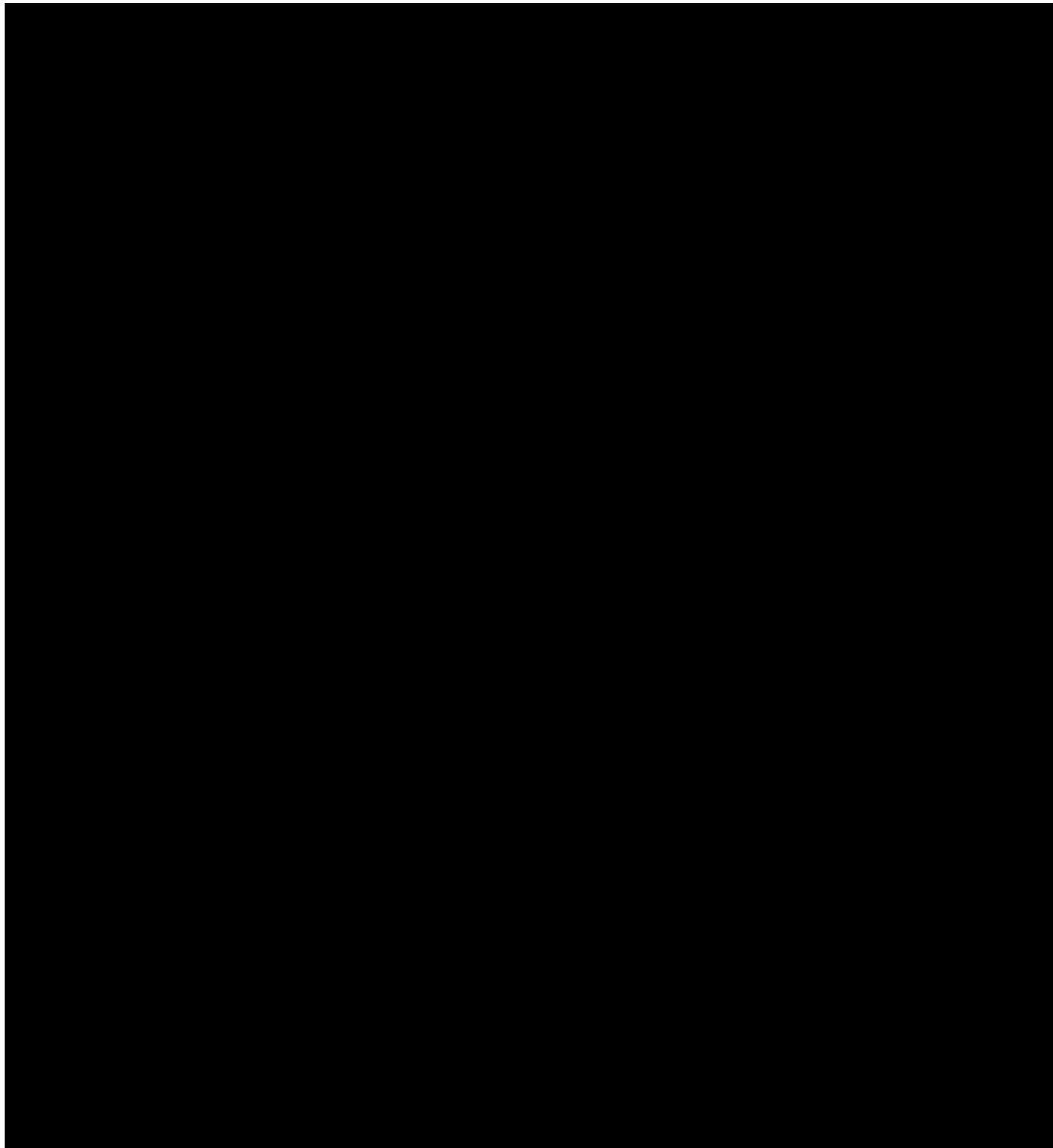


7.3 Identify and provide an estimate of cost, supported by an independent third party, for all proposed or anticipated interconnection and transmission upgrades, including any transmission upgrades beyond the point of interconnection that are needed to ensure delivery of energy from the Offshore Wind Generation Facility into NYCA. Describe measures to identify and control the regulatory and operational risks related to the delivery of energy from the Offshore Wind Generation Facility.

Detailed cost estimates of SDU and SUF [REDACTED] are provided for [REDACTED] in the following documents: [REDACTED]

[REDACTED] A summary of the cost estimates is provided in **Tables 7.3-1** and **7.3-2**, below.

The potential required upgrades [REDACTED]
[REDACTED] are included in **Figure 7.3-1** and **Figure 7.3-2**.
[REDACTED]
[REDACTED]



The additional internal study [REDACTED]
[REDACTED] is included as **Attachment 7.3-1**. [REDACTED]



[REDACTED]

The range in costs and methodologies between [REDACTED] reports is typical for studies at this stage of the process, and the final upgrades and costs will be determined through the NYISO study and interconnection process. The conclusions of this study have also been incorporated into the Project's cost analysis and pricing.

7.4 Demonstrate that energy and associated ORECs generated by the facility can be delivered into the NYCA. For an Offshore Wind Generation Facility interconnecting in an adjacent Control Area, describe how Proposer intends to fulfill the External Project Delivery Requirement.

[REDACTED]

[REDACTED] CRIS, under the Large Facility Interconnection Procedures for interconnection, must be in compliance with NYISO's Deliverability Interconnection Standard.

[REDACTED]

[REDACTED] To meet the NYISO Deliverability Interconnection Standard, the Developer must fund or commit to fund any System Deliverability Upgrades identified for its project in the Class Year Deliverability Study.

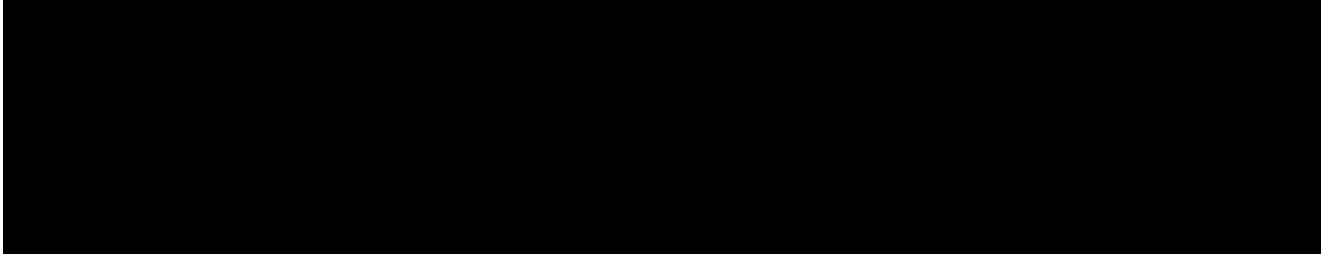
When a Developer elects CRIS, NYISO will evaluate the deliverability of the Large Facility by applying the test methodology described in Section 25.7 of Attachment S to NYISO's OATT. NYISO will apply this test methodology to identify the System Deliverability Upgrades, if any, needed to make the Large Facility deliverable, per OATT 30.3.2.7 Attachment X - Standard Large Facility Interconnection. These standards insure that the ORECs generated by the Offshore Wind Generation Facility can be delivered into NYCA.

To insure reliable operation the New York Bulk Power System, Operating Reserves are needed to respond to generation and transmission contingency events. Operating reserves can be converted to energy in the event of a real-time power system need. Generation contingencies require a combination of 10-minute reserve (spinning and non-spinning) products to replace lost capacity, and 30-minute reserve products to be able to restore the 10-minute products to prepare for other potential events.

The NYISO determines Operating Reserves based on New York State Reliability Council reliability rules, North American Electric Reliability Corporation requirements and Northeast Power Coordinating Council requirements. These studies will be completed by the NYISO at a date to be determined pursuant to its tariff provisions and will address the impact [REDACTED] of Offshore Wind injection into the Bulk Power System.

Security Constrained Unit Commitment (SCUC) is utilized by the NYISO to dispatch generation with consideration of bid cost, forecasted load, generation constraints, transmission constraints, local reliability rules and reserve requirements. SCUC will insure the lowest cost supply is dispatched with considered for all other parameters to insure the safe and reliable operation of the grid and delivery of OREC's.

7.5 Provide detail regarding the available capacity, at the time of submission, of the proposed Injection Point.





LIBERTY WIND

SECTION 8 - ENVIRONMENTAL ASSESSMENT AND PERMIT ACQUISITION PLAN

Proposal for New York State Energy Research and Development Authority in response to
Request For Proposals for Purchase of Offshore Wind Renewable Energy Certificates



Photo: Veja Mate offshore wind farm


PUBLIC



SECTION 8 ENVIRONMENTAL ASSESSMENT AND PERMIT ACQUISITION PLAN

OVERVIEW

Vineyard Wind remains the company with the most offshore wind permitting knowledge and most successful permitting experience in the US. In 2017, Vineyard Wind became the first offshore wind company to submit a Construction and Operations Plan (COP) to the Bureau of Ocean and Energy Management (BOEM) and is on track to complete federal permitting for the nation's first commercial-scale offshore wind project in 2019.





8.1 Provide a comprehensive list of all the permits, licenses, and environmental assessments and/or environmental impact statements required to construct and operate the Project. Along with this list, identify the governmental agencies that are responsible for issuing approval of all the permits, licenses, and environmental assessments and/or environmental impact statements. If a Proposer has secured any permit or has applied for a permit, please indicate this in the response.

Liberty Wind is comprised of several major elements that determine the scope of federal, state, regional, and local permitting requirements. Project elements located offshore and beyond state territorial waters (i.e., beyond three nautical miles seaward of the low water mark of the shore) are exclusively within federal jurisdiction. These Project elements include the wind turbine generator (WTG) array, inter-array cabling, offshore electrical service platform (ESP), and offshore export cables.

The following sections present more detail regarding the federal, state, county, and local permits and reviews assumed to be required for the Project. A summary of all the permits, licenses, and environmental assessments or statements for the Project is provided in **Tables 8.1-1, 8.1-2, and 8.1-3.**



LIST OF FEDERAL PERMITS OR APPROVALS REQUIRED

As described in more detail below, the principal federal authorizations and permits required to construct and operate the Project include:

- BOEM's Office of Renewable Energy Programs' approval of Vineyard Wind's COP, along with submission of a Facilities Design Report (FDR) and Fabrication & Installation Report (FIR);
- A permit to construct structures in navigable waters under Section 10 of the Rivers and Harbors Act of 1899, issued by the US Army Corps of Engineers (ACOE);
- A Clean Water Act (CWA) Section 404 permit to discharge dredge or fill into waters of the United States, issued by the ACOE;
- A Clean Air Act (CAA) Outer Continental Shelf (OCS) permit for emissions from vessels and equipment used during construction and operation of the Project, issued by the US Environmental Protection Agency (EPA);
- An Incidental Harassment Authorization (IHA) or Letter of Authorization (LOA) under the Marine Mammal Protection Act (MMPA) for construction-related noise associated with pile driving, issued by the US National Marine Fisheries Service (NMFS);
- US Coast Guard (USCG) issuance of Private Aids to Navigation; and
- Federal Aviation Administration (FAA) determinations of "no hazard," for any structures within FAA jurisdiction (including construction).

Other required permits that do not involve environmental or other reviews before issuance include:

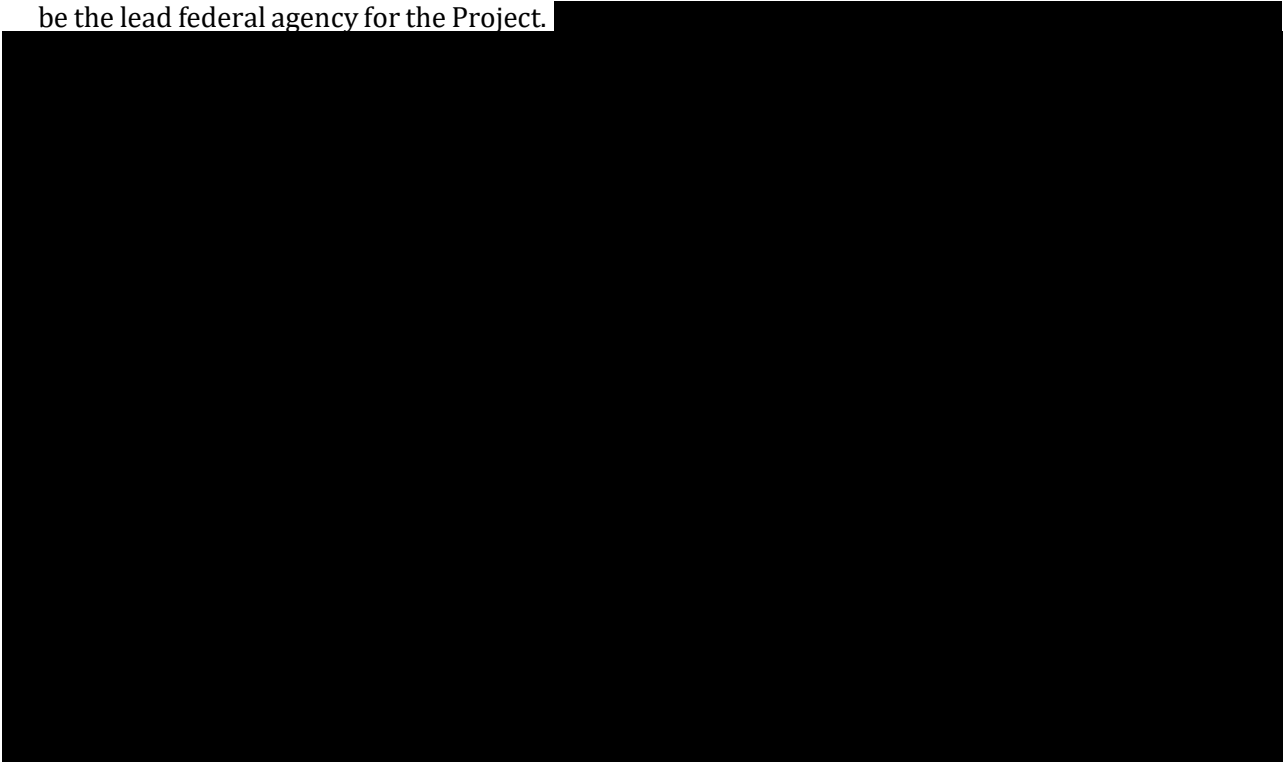
- A National Pollutant Discharge Elimination System (NPDES) General Permit for Stormwater; and
- A Notification for Notice to Mariners and information to be shared with the National Ocean Survey for updates to nautical charts (for the portion in navigable waters).

Note that the list above does not include required reviews by other agencies with which the lead permitting agency consults, as described below.



FEDERAL PERMITTING PROCESS AND APPROVALS

Bureau of Ocean Energy Management: BOEM has jurisdiction under the Outer Continental Shelf Lands Act to issue leases, easements, and rights-of-way (ROWs) for the development of renewable energy on the OCS and to ensure that activities conducted on the OCS are carried out in a manner that adequately addresses environmental protection, safety, protection of US national security, and protection of the rights of others to use the OCS and its resources. BOEM authorizes development on the OCS through its review and approval of a project's Site Assessment Plan (SAP) and COP and will be the lead federal agency for the Project.



Army Corps of Engineers: Section 10 of the Rivers and Harbors Act of 1899 prohibits the unauthorized obstruction or alteration of any navigable water. A Section 10 permit from the US Army Corps of Engineers (ACOE) is needed for the installation of the WTGs and the ESP, the installation of the offshore cable systems, and the cable landfall structures. Section 404 of the CWA prohibits discharges of dredge or fill material into waters of the US (i.e., waters beyond the three nautical mile limit for state territorial waters). A Section 404 permit from the ACOE is needed because construction will involve dredging and potentially backfilling portions of the seabed associated with the installation of the offshore export cable. Like BOEM, the ACOE must comply with its obligations under NEPA, NHPA, MSFCMA, MBTA, and ESA. However, to avoid duplication of effort, the ACOE will likely be a cooperating agency with BOEM through the NEPA process.

Environmental Protection Agency: A CAA permit is required for emissions from vessels and equipment used during construction and operation of the Project on the OCS. OCS sources subject to the permit include any equipment or activity that has the potential to emit any air pollutant. A vessel itself is not considered an OCS source unless it attaches to the seabed, but vessel emissions associated with an OCS source are included in the permit. The EPA will coordinate with BOEM to satisfy its obligations under the ESA and other relevant statutes.



National Marine Fisheries Service: An IHA or LOA under the MMPA is necessary for construction, principally because of the potential noise impacts to marine mammals associated with pile driving. Under the MMPA, the noise levels associated with construction have the potential to “harass” marine mammals and, therefore, an authorization is required. In addition, Vineyard Wind will consult with NMFS under the MMPA regarding pre-construction geophysical and geotechnical surveys.

Federal Aviation Administration: The FAA requires a public notice of the proposed construction of a structure that is more than 200 feet (ft) above ground level or which is within certain distances of airports. Even though the WTGs for the Project are outside of the FAA’s jurisdiction, Vineyard Wind will likely consult with the FAA on the Project’s construction and the movement of any structures that exceed 200 ft. Vineyard Wind will also consult with the US Department of Defense Siting Clearing House with respect to military air traffic.

Coastal Zone Management and Coastal Resources Management Council: The CZMA gives states the authority to review federal actions that impact their coastal uses and/or resources to ensure that such actions are consistent with a state’s federally approved coastal management program and policies. The New York State Department of State (NYS DOS) Office of Planning and Development is responsible for implementing the federal consistency review process, pursuant to the CZMA (16 U.S.C. § 1456).

Table 8.1-1 lists the expected federal permits required for the Project. The schedule for filings and approvals is illustrated in **Section 8.4** below.

Table 8.1-1 Expected Federal Permits for Liberty Wind ¹

Agency/Regulatory Authority	Permit/Approval
Bureau of Ocean Energy Management ²	Survey Plan Site Assessment Plan approval Construction and Operations Plan approval National Environmental Policy Act review National Historic Preservation Act Section 106 Review
US Environmental Protection Agency	National Pollutant Discharge Elimination System General Permit for Construction Activities Outer Continental Shelf Air Permit
US Army Corps of Engineers	Individual Clean Water Act Section 404 (Required for side-casting of dredged material and placement of foundations, scour protection, and cable protection) Rivers and Harbors Act of 1899 Section 10 Permit (Required for all offshore structures and dredging activities) Section 103 of the Marine Protection, Research, and Sanctuaries Act of 1972; 33 CFR Part 325



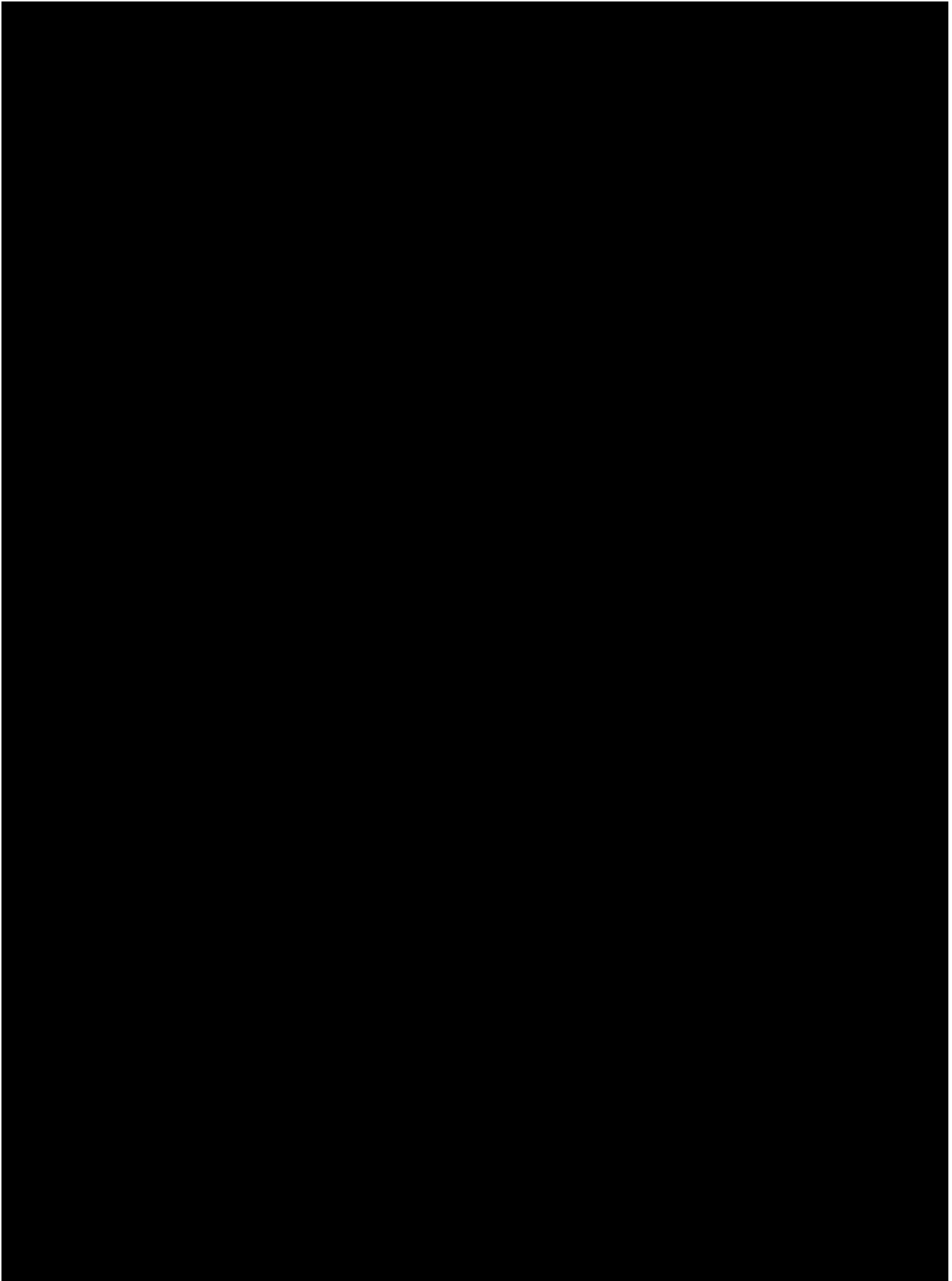
Table 8.1-1 Expected Federal Permits for Liberty Wind ¹ (Continued)

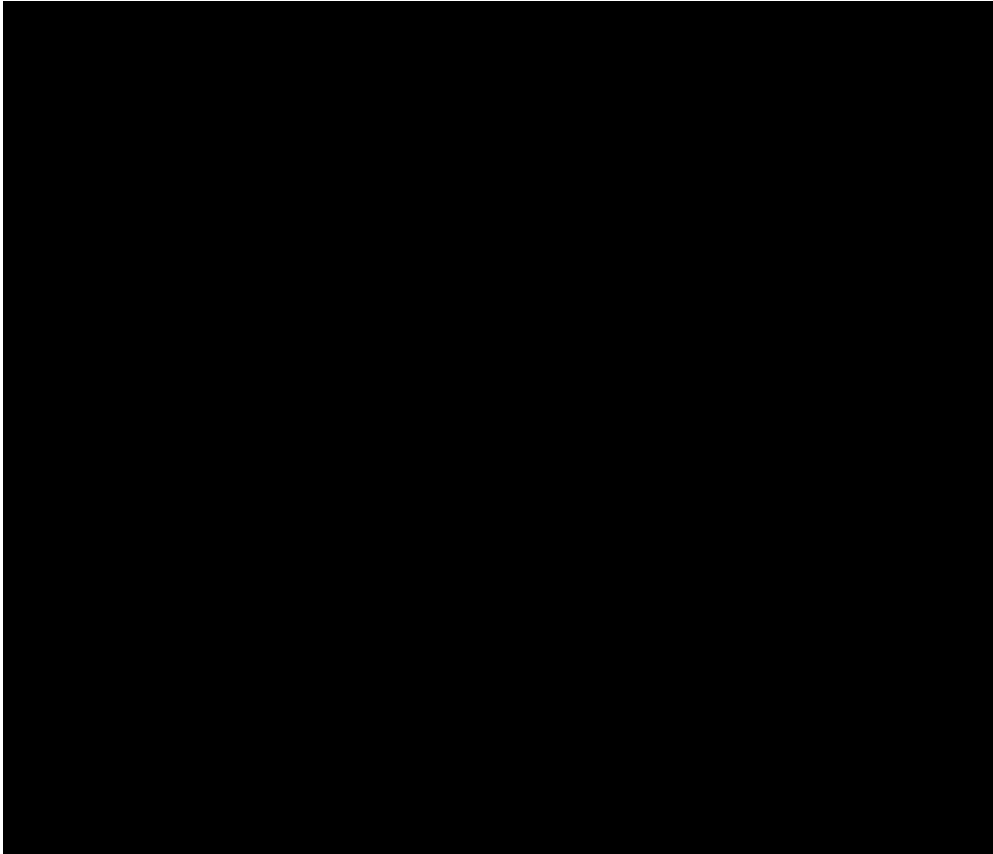
Agency/Regulatory Authority	Permit/Approval
US National Marine Fisheries Service	Incidental Harassment Authorization or Letter of Authorization
US Coast Guard	Private Aids to Navigation authorization
US Fish and Wildlife Service (USFWS) and NOAA Fisheries	Section 7 – Federal Endangered Species Act Consultation Process
NOAA Fisheries/Office of Ocean and Coastal Resource Management	Coastal Consistency Determination Interagency consultation between NOAA and BOEM Essential Fish Habitat Assessment
USFWS	Migratory Bird Treaty Act review
Federal Aviation Administration	No Hazard Determination Notice of Proposed Construction or Alteration
National Park Service (NPS)	Right-of-Way for utilities to pass over, across or through a National Park System, which includes areas of land and water administered by NPS

STATE PERMITTING PROCESS AND APPROVALS

Vineyard Wind will follow the process administered by the NY PSC that permits the Project pursuant to Article VII of the New York State Public Service Law and associated NY PSC regulations. Article VII and the cited regulations require the submission of detailed information on all aspects of the proposed transmission line and appurtenant facilities located within state, county, and local jurisdictions. The Article VII process is designed to avoid conflicting mandates that could result if numerous permits were required at the state, county, and local levels for the siting of a “major utility transmission facility” such as the Project.

ARTICLE VII





OTHER EASEMENTS AND RIGHTS

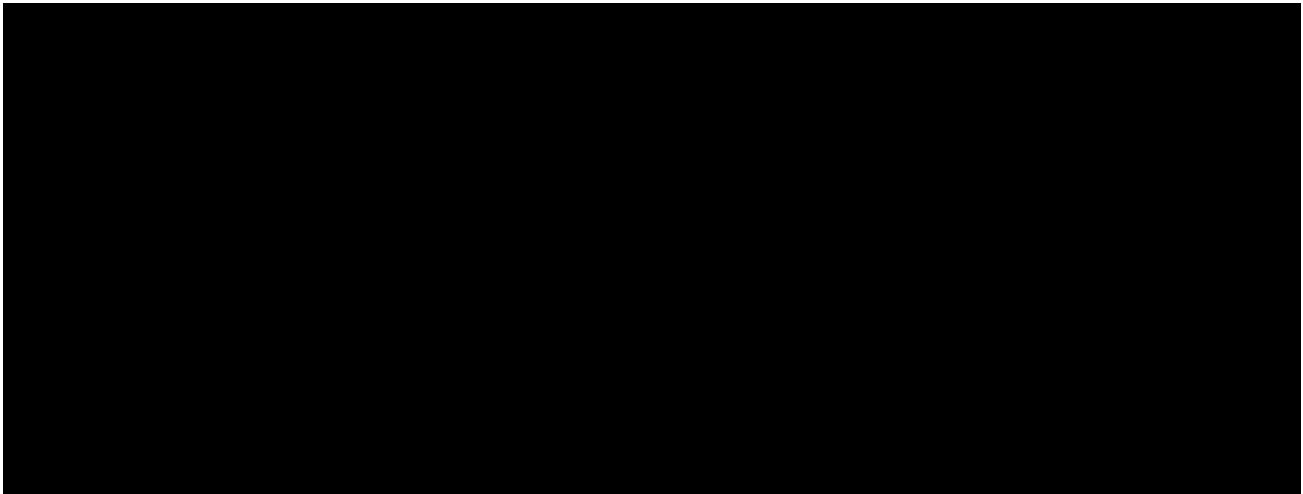
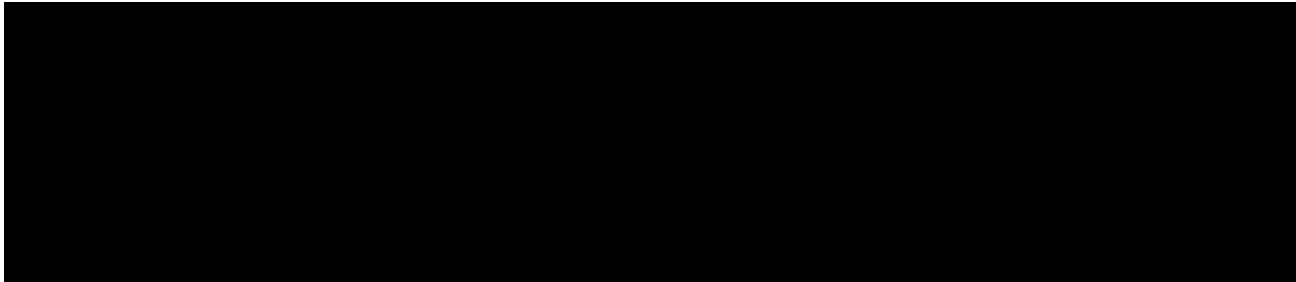


Table 8.1-2 lists the expected New York State permits required for the Project.



Table 8.1-2 Expected New York State Permits for Liberty Wind

Agency/Regulatory Authority	Permit/Approval
New York State Department of Public Service ¹	Certificate of Environmental Compatibility and Public Need under Article VII and Clean Water Act Water Quality Certificate
New York Office of General Services	State Submerged Lands easement
New York State Department of Environmental Conservation	State Pollutant Discharge Elimination System permit
New York State Department of Transportation	Highway Work permit
New York State Department of Transportation	Highway Use and Occupancy permits
New York State Department of Motor Vehicles	Vessel registration



COUNTY AND LOCAL PERMITTING PROCESS AND APPROVAL

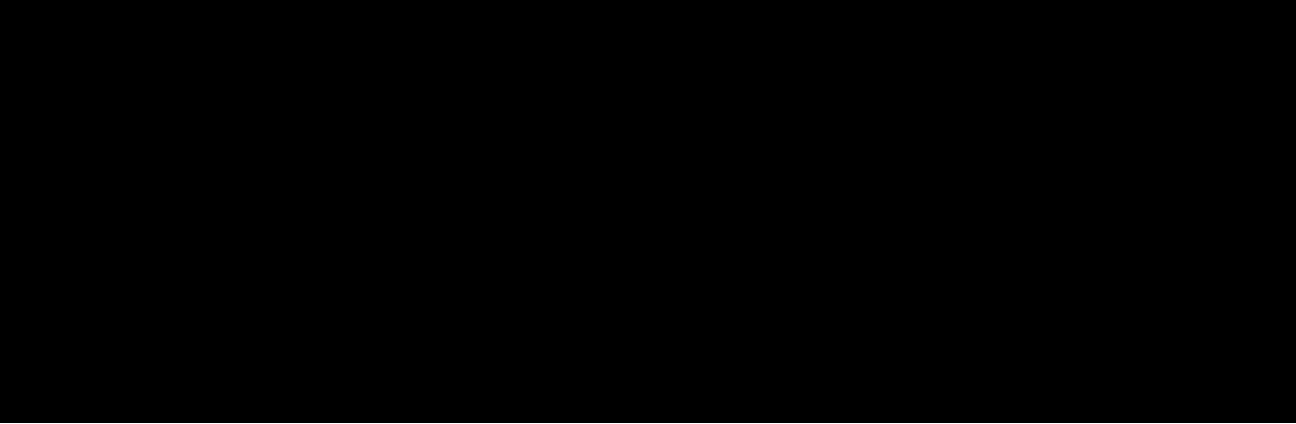
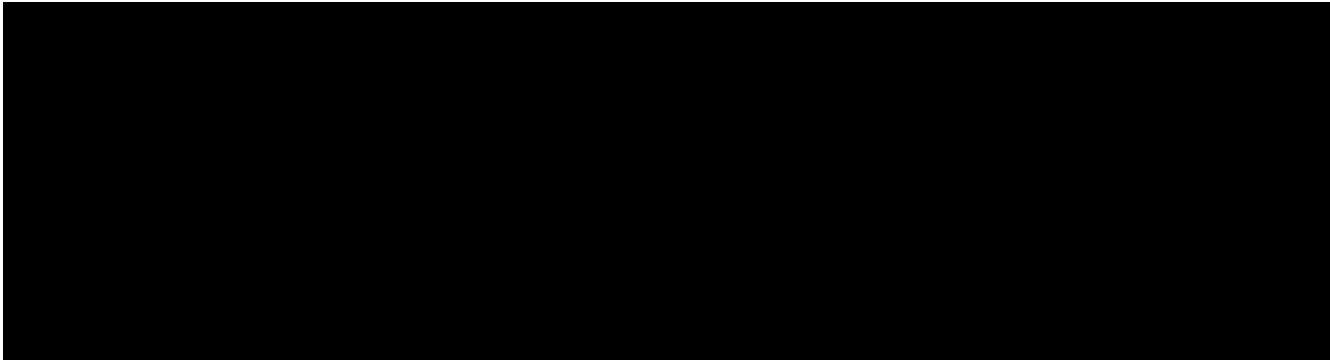
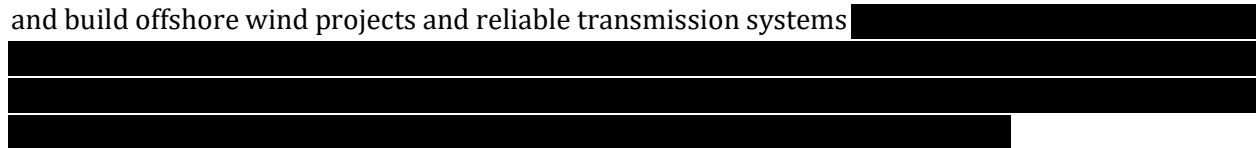


Table 8.1-3 lists the expected regional and local level reviews and permits required for the Project.



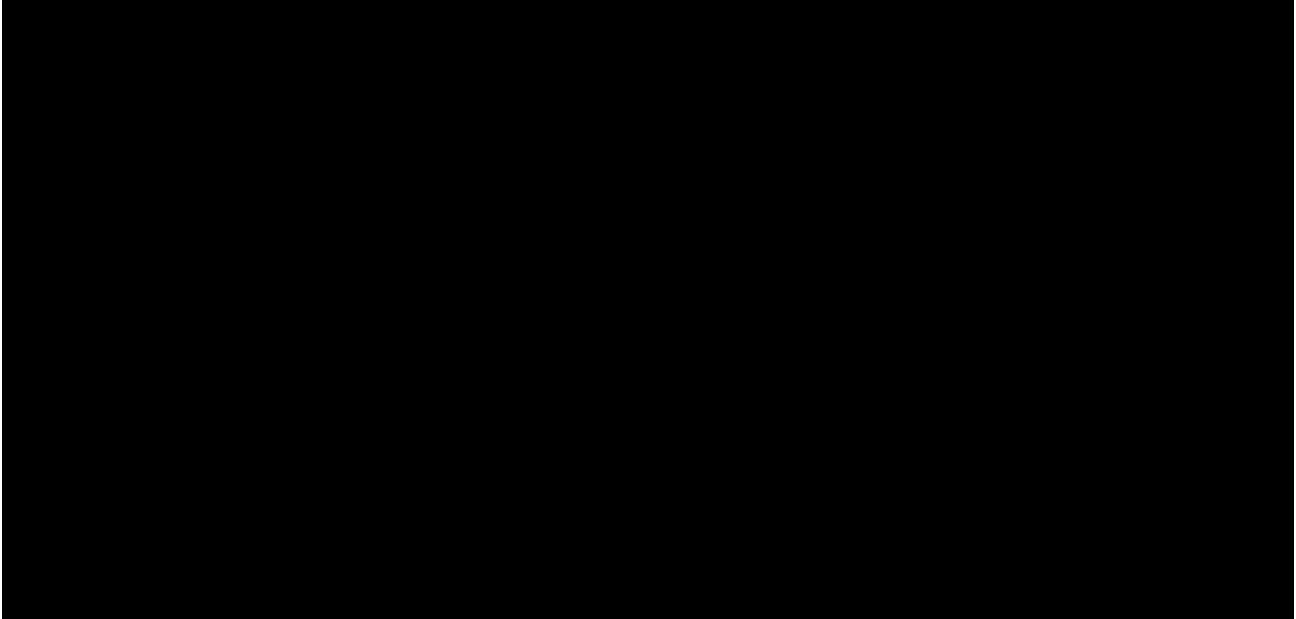
A WORLD CLASS PERMITTING TEAM WILL ENSURE THE SUCCESS OF THE PROJECT

Liberty Wind is well-positioned to successfully and efficiently complete the permitting process because it is backed by a Project team with an almost an incomparable expertise to design, permit, and build offshore wind projects and reliable transmission systems

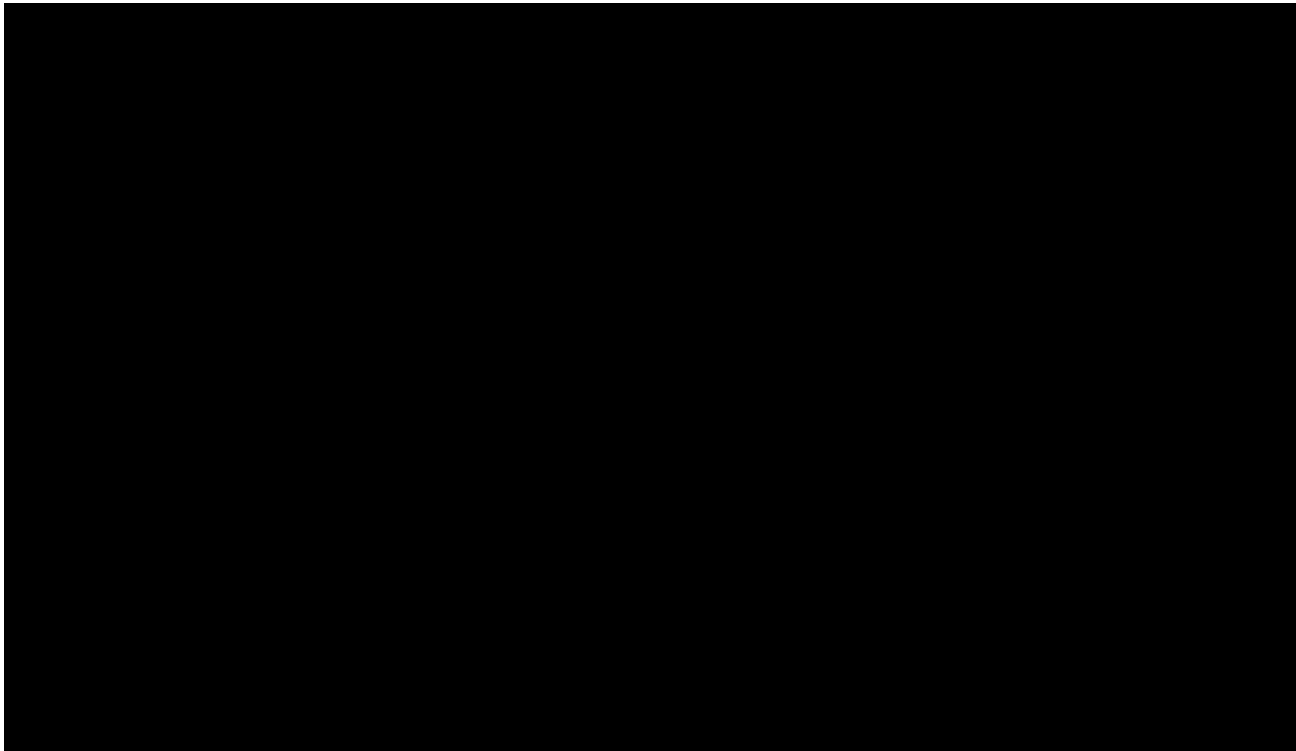


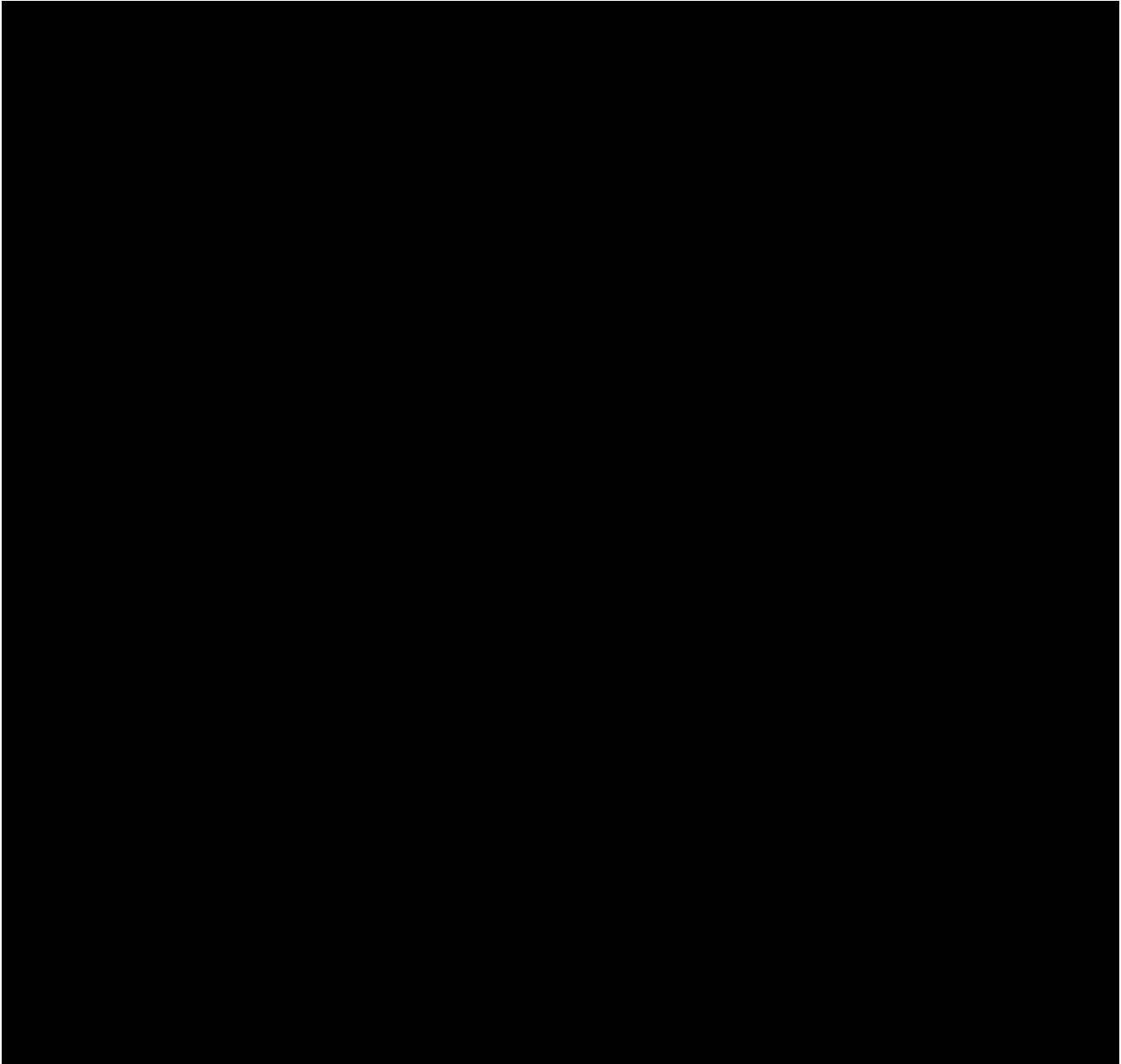
Vineyard Wind's permitting team includes global and national leaders in offshore wind and energy infrastructure permitting.



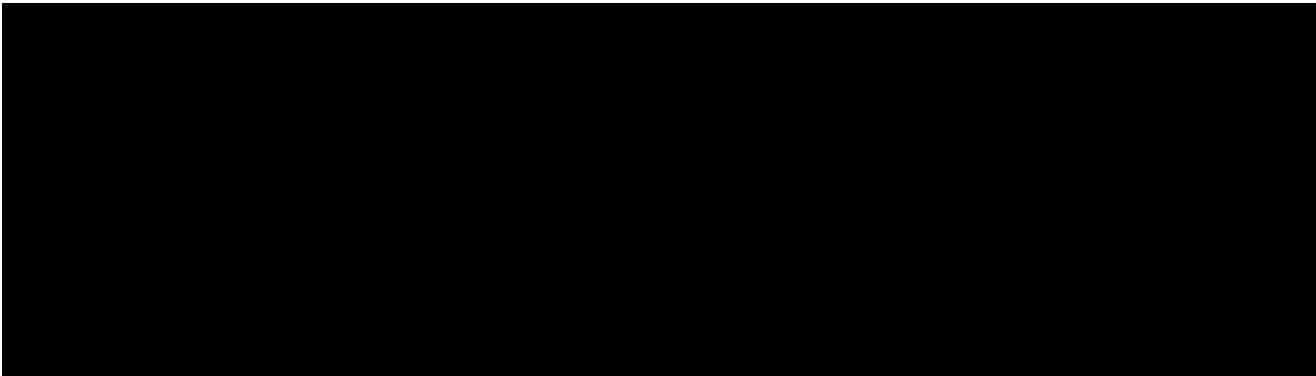


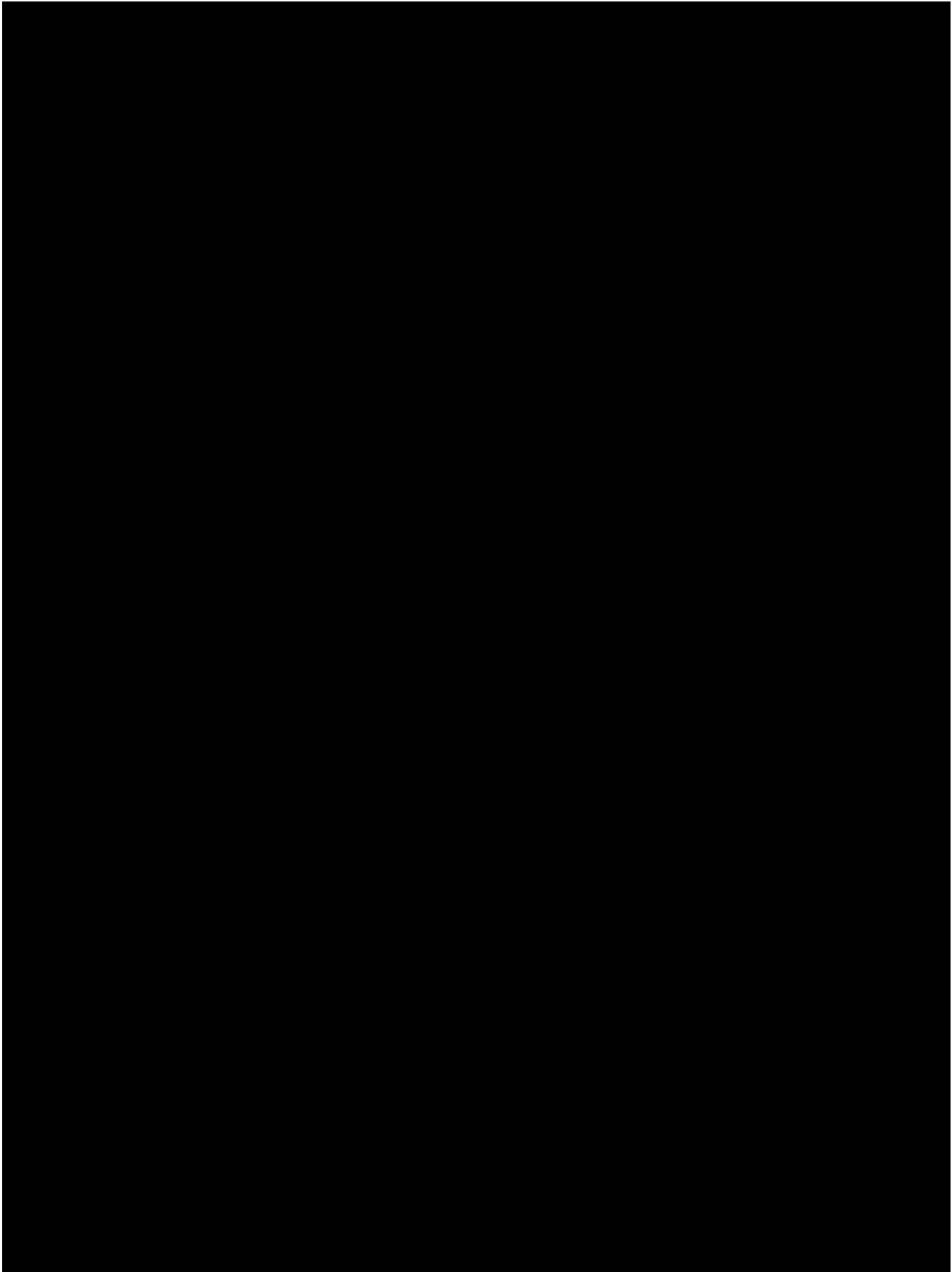
8.2 Provide the anticipated timeline for seeking and receiving the required permits, licenses, and environmental assessments and/or environmental impact statements. Include a project approval assessment which describes, in narrative form, each segment of the process, the required permit or approval, the status of the request or application and the basis for projection of success by the milestone date. All requirements should be included on the project schedule in Section 12.

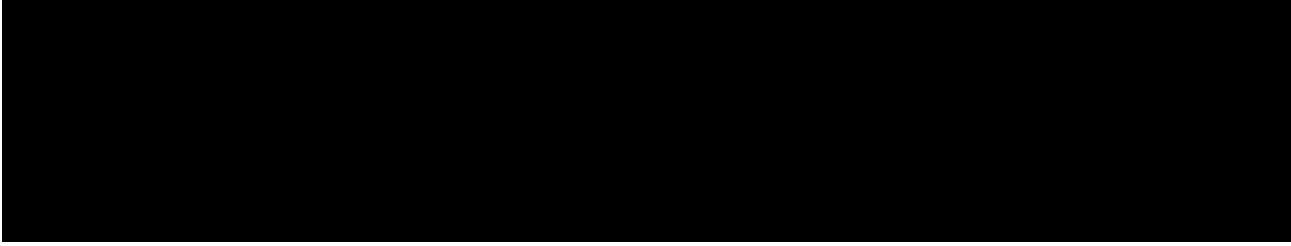




FEDERAL PERMITTING TIMELINE





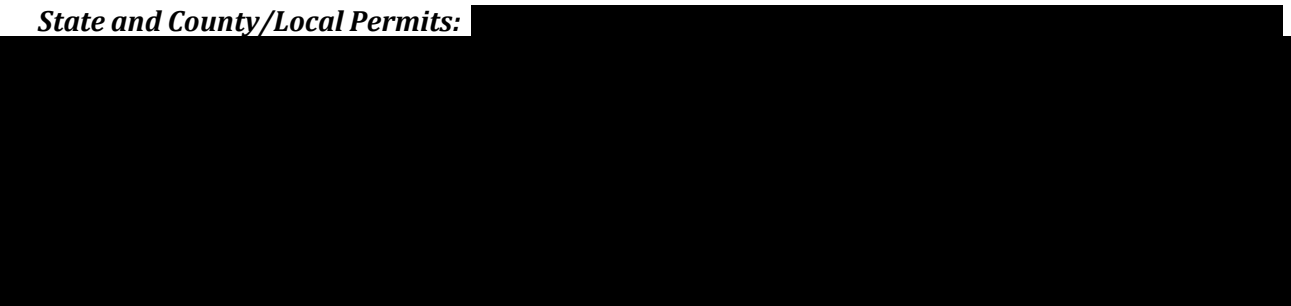


NEW YORK/ COUNTY / LOCAL PERMITTING TIMELINES

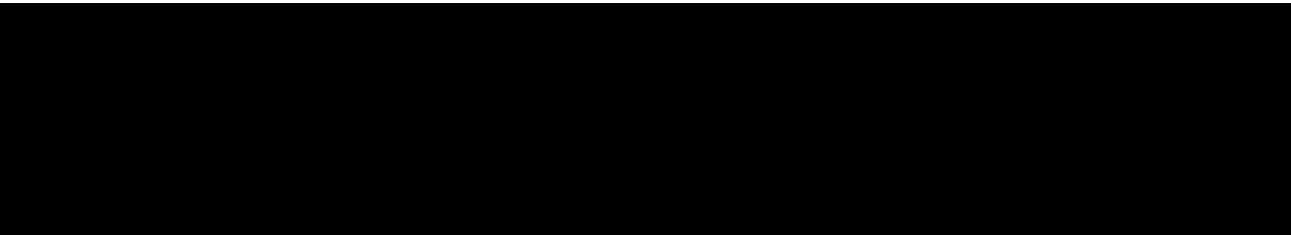
New York Public Service Commission Article VII Certificate:



State and County/Local Permits:



8.3 Provide the SAP and COP, if completed. If the SAP and/or COP are not completed, provide the status of development of these plans and a proposed plan and timeline for completion.





LIBERTY WIND

SECTION 9 - ENGINEERING AND TECHNOLOGY

Proposal for New York State Energy Research and Development Authority in response to Request For Proposals for Purchase of Offshore Wind Renewable Energy Certificates




Photo: Veja Mate offshore wind farm





SECTION 9 ENGINEERING AND TECHNOLOGY




OVERVIEW


The engineering and construction concept for Liberty Wind (the “Project”) uses commercially available and highly reliable technology, and is based on Vineyard Wind’s and the parent companies’ (i.e., Copenhagen Infrastructure Partners [CIP] and Avangrid Renewables) experience delivering some of the most modern and leading offshore wind and transmission projects worldwide, as previously described in **Section 2**.








The Project is also distinguished by a sound construction and logistics concept with considerable resources already invested in analyzing and performing simulations of the various contractors' vessels spread and operational capabilities. 



Although Vineyard Wind has not yet made any final decisions regarding manufacturers for the Project, the company has already completed extensive engineering assessments and investigations of supply chain capabilities and options in New York, the US, and abroad (see response to **Questions 9.1.f and 9.1.i.**) 



Vineyard Wind will continue to promote and pursue opportunities for using the growing New York-based and US supply chain as the Project moves forward. **Figure 9.1-9** shows a list of the different supply packages for the Project as well as the relevant potential component manufacturers and supply chain partners that Vineyard Wind is has engaged with.

Vineyard Wind's procurement strategy, including a timeline for selecting equipment manufacturers, is described in more detail in response to **Question 9.1.i** and a detailed timeline is illustrated in **Figure 9.1-11**. The procurement timeline has been developed to support the Project schedule described in **Section 10**.

-
- 9.1 *Provide a preliminary engineering plan which includes at least the following enumerated information. If specific information is not known, identify manufacturers, vendors, and equipment that will be considered.:*
- a. Type of foundation, Offer Capacity, and generator lead line transmission technology*
 - b. Major equipment components to be used, including nacelle, hub, blade, tower, foundation, transmission structures and platforms, electrical equipment and cable)*
 - c. Manufacturer of each of the equipment components as well as the location of where each component will be manufactured*
 - d. Status of acquisition of the equipment components*
 - e. Status of any contracts for the equipment Proposer has or Proposer's plan for securing equipment and the status of any pertinent commercial arrangements*
 - f. Equipment vendors selected/considered*
 - g. Track record of equipment operations*
 - h. Design considerations (technology selection, layout) for climate adaptation and resiliency such as sea level rise, potential impacts from increased frequency and severity of storms (i.e. superstorms, hurricanes), seismic activity, etc.*
 - i. In the event the equipment manufacturer has not yet been selected, identify in the equipment procurement strategy the factors under consideration for selecting the preferred equipment as well as the anticipated timing associated with the selection of the equipment manufacturer, including the timing for binding commercial agreement(s).*
-

Each of above topics will be addressed individually and sequentially in the following sections.

PRELIMINARY ENGINEERING PLAN

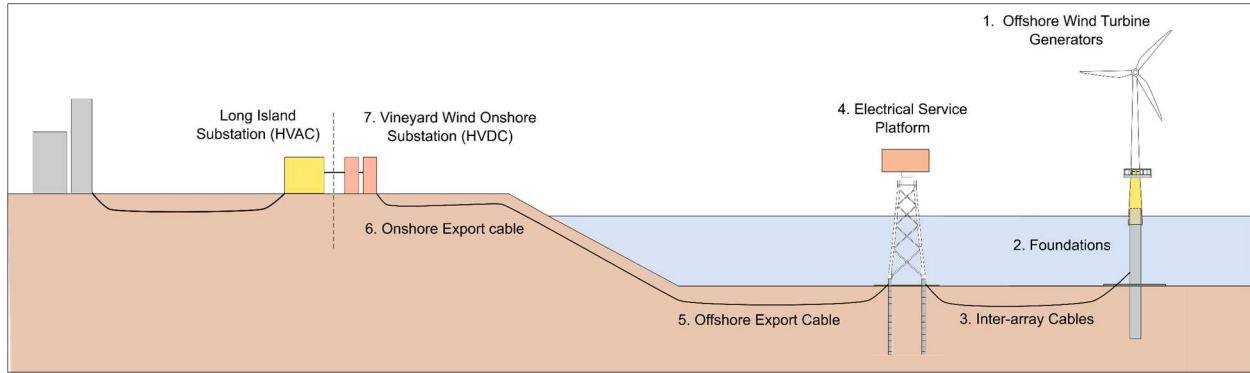
The following section will provide information in relation to:

-
- a. Type of foundation, Offer Capacity, and generator lead line transmission technology*
 - b. Major equipment components to be used, including nacelle, hub, blade, tower, foundation, transmission structures and platforms, electrical equipment and cable*
-

The major equipment components to be used are shown in the figure 9.1-1.



Figure 9.1-1 Offshore Wind Generation and Transmission System



1. **Offshore Wind Turbine Generators:** [REDACTED]

2. **Foundations:** The WTGs will be erected in the Lease Area on foundations consisting of a monopile support structure with a transition piece (TP). Subject to detailed engineering, the foundations could be based on a jacket concept if the Project moves forward with the largest possible WTGs

Inter-array Cables: [REDACTED]

Electrical Service Platform: [REDACTED]

5. **Offshore Export Cable:** [REDACTED]

6. **Onshore Export Cable:** [REDACTED]

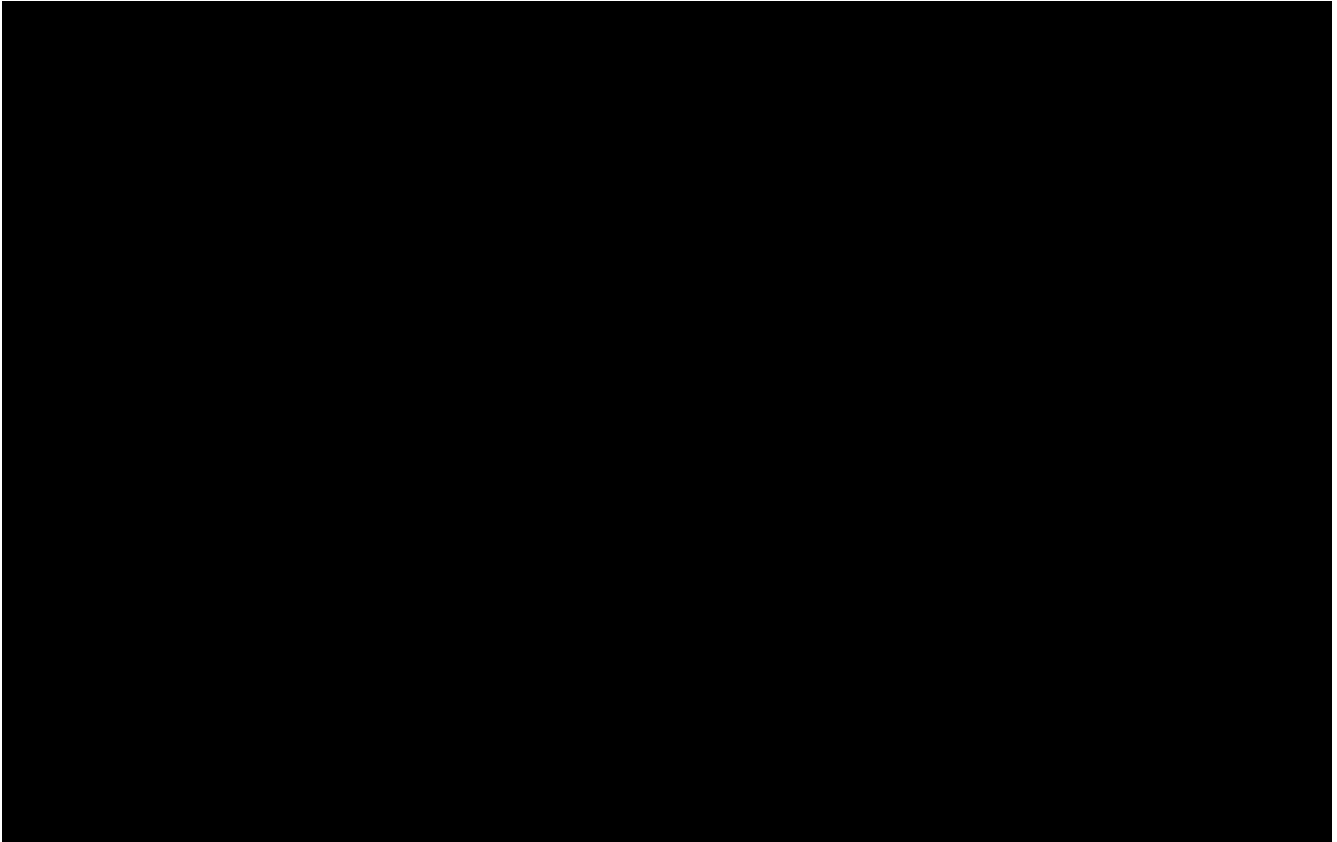
Onshore Substation [REDACTED]

OFFSHORE WIND TURBINE GENERATORS

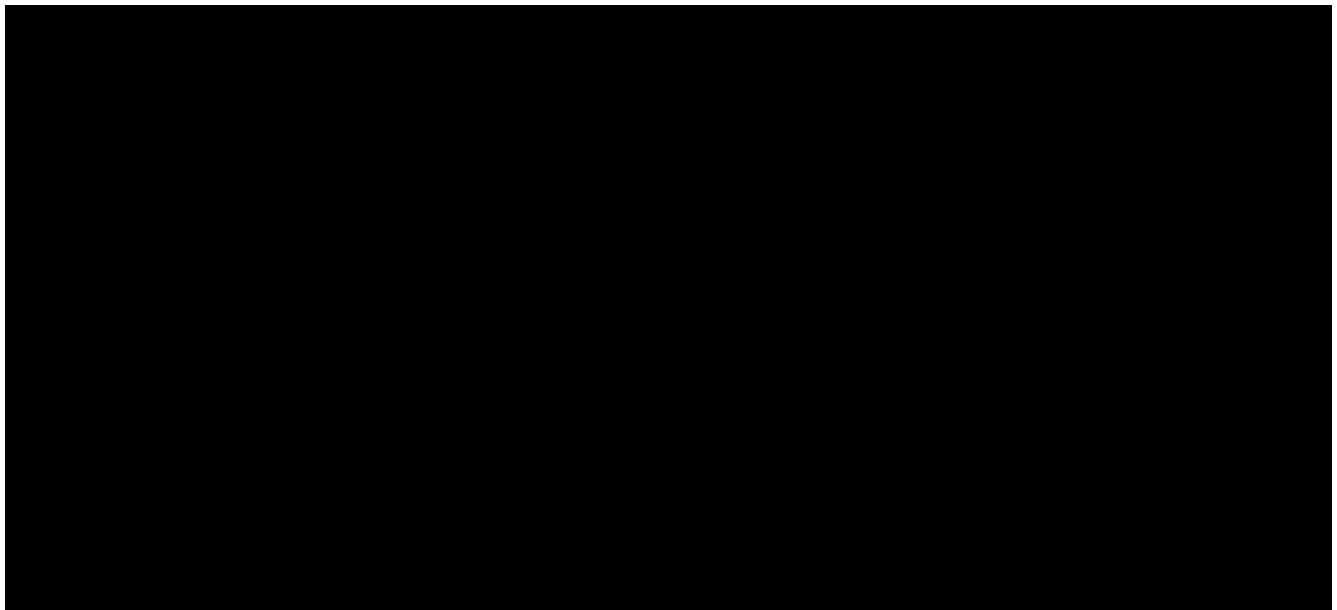
A WTG consists of a steel tower [REDACTED]. On top of the WTG tower is a nacelle (housing) and hub. The nacelle features a driveshaft and gearbox or direct-drive technology (depending on final WTG type selected), as well as the electrical generator and electric motors to yaw the turbine and workspace. [REDACTED]

[REDACTED] The nacelle also contains a full array of instrumentation, controls, fire protection systems and other safety equipment,

ventilation and cooling, and ancillary equipment. Wind sensors mounted on the top of the nacelle are used to control a yaw system, which ensures that the nacelle is facing into the wind, thus maximizing power production. **Figure 9.1-2** provides a schematic overview of a WTG.



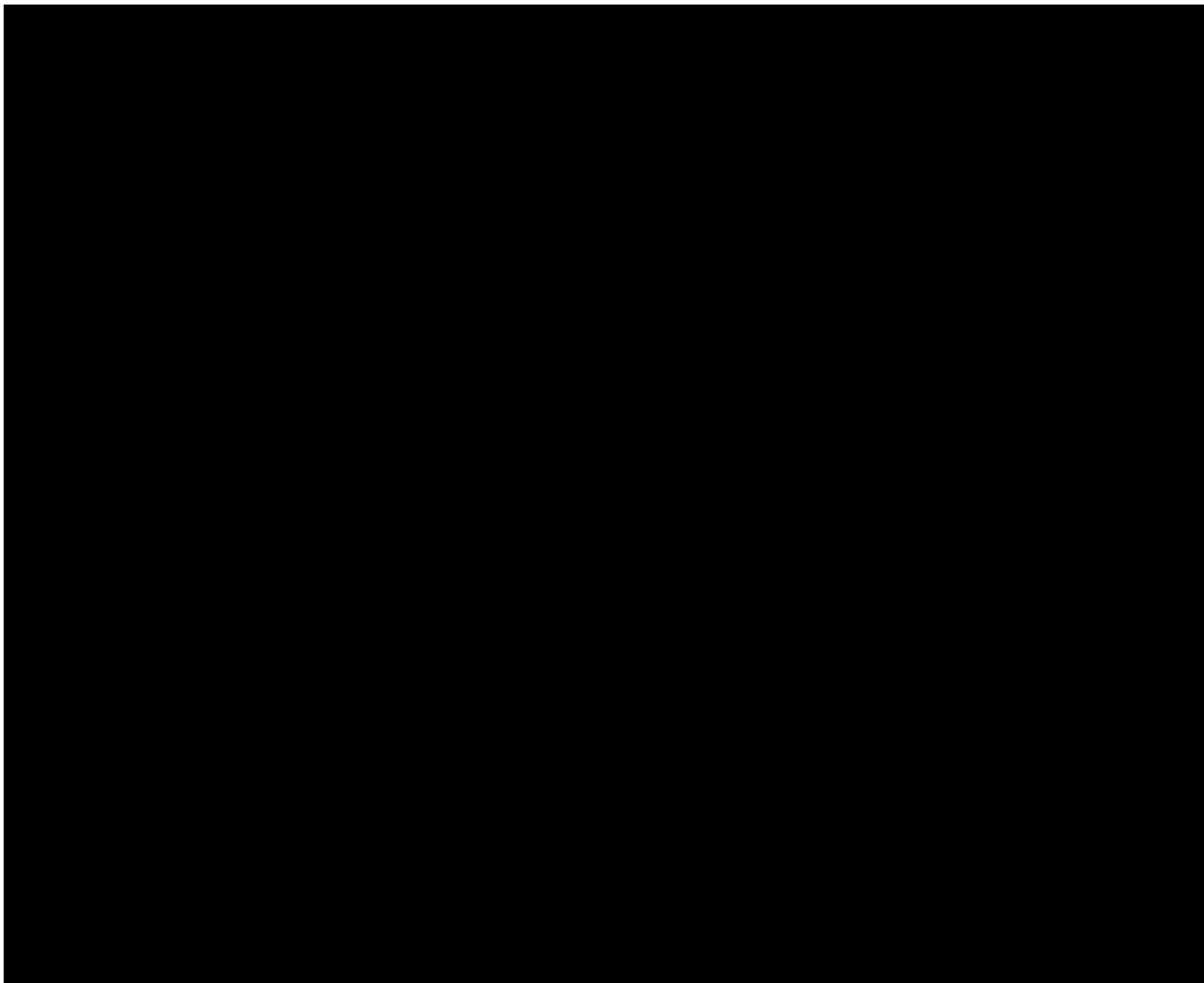
The WTGs currently under consideration for the Project are:



FOUNDATIONS

The Project will use either monopiles or jackets as the support structure for the WTGs.

Monopile Concept: A monopile is a single, hollow cylinder fabricated from steel that is secured to the seabed. The monopile concept is illustrated in **Figure 9.1-3**.



The foundation includes the following: inter-array cable hang-off supports, corrosion protection systems (both internally and externally), a boat landing for accessing each turbine, Davit crane to bring tools and parts up from the service vessel, navigation aids, ID marking and lights, external and internal platforms, various electrical components, and scour protection.

Jacket Concept: The jacket design concept consists of three to four piles, a large lattice jacket structure, and a TP. The jacket concept is illustrated in **Figure 9.1-4** below.



[REDACTED]

The jacket structure is supported and secured by pre-installed driven piles (one per leg). Alternatively, the jacket is secured to the sea floor by way of slender piles, which are driven through “sleeves” or guides mounted to the base of each leg of the jacket structure. The jacket will also contain secondary structures, such as boat landings and cable tubes. The jacket will also be equipped with a corrosion protection system designed in accordance with relevant standards. The jacket is fixed to the piles and a TP is fitted to obtain the turbine loads and transfer them to the jacket structure. The TP will contain secondary structures, such as tower flange for mounting the WTG, internal and external platforms, and various types of electrical equipment needed during installation and operation.

INTER-ARRAY CABLES

[REDACTED] Medium voltage inter-array cables will connect the individual WTGs to the ESP. The total length of the cables will be optimized according to the Project’s layout and model of WTG chosen. Each cable includes three conductors and each conductor is encapsulated in solid cross-linked polyethylene (XLPE) insulation. Water-blocking sheathing is used to prevent water infiltration of the cable. The three insulated conductors are twisted with a solid synthetic filler between the conductors. The twisted or bundled conductors are then wrapped in wire armoring and encased in a tough outer sheath. The conductor material, aluminum or copper, and cross sections are subject for optimization and will be decided at a later stage in the design process and will depend on the final number of turbines per string and cable length. [REDACTED]

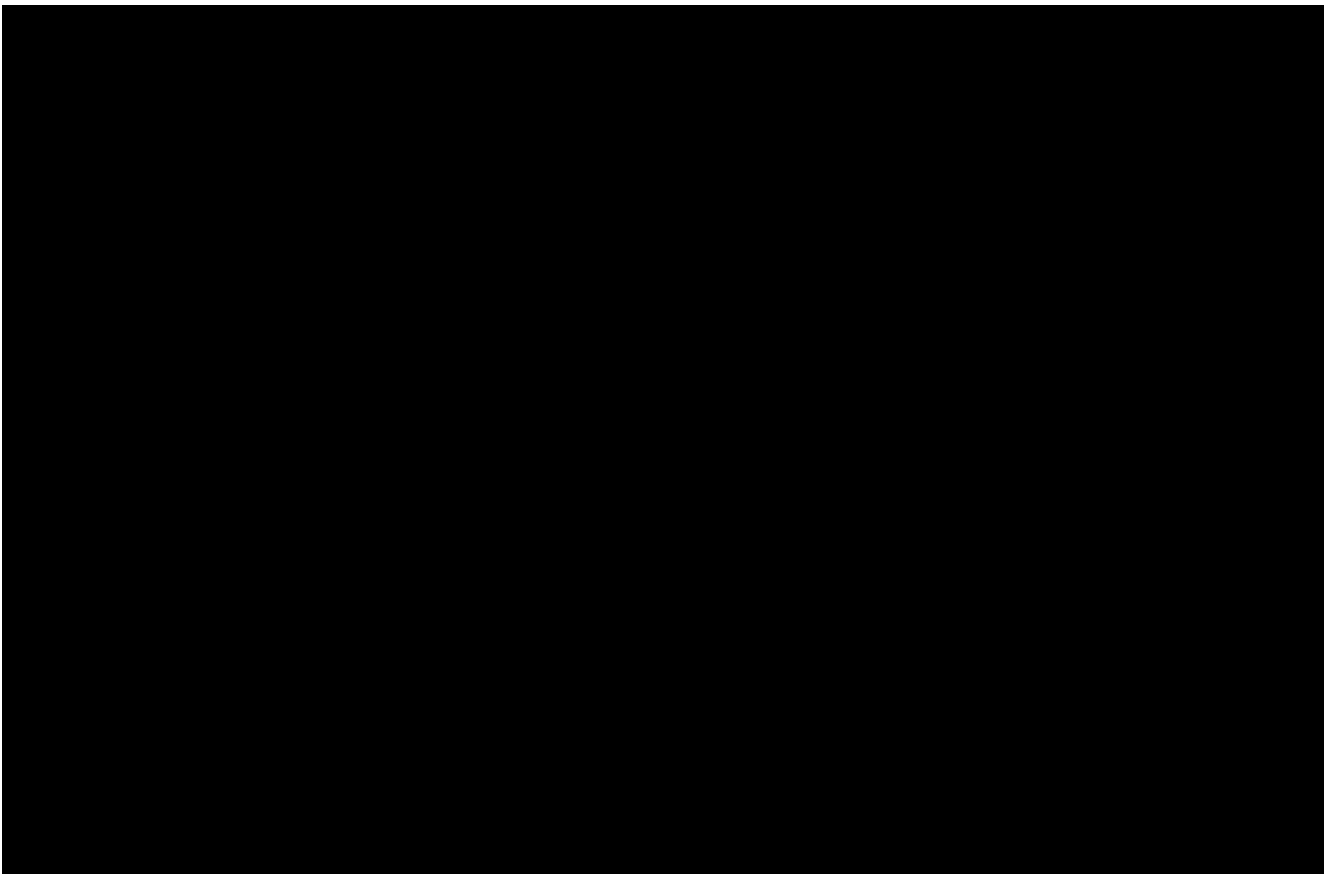


ELECTRICAL SERVICE PLATFORM

The purpose of the ESP is to collect the power generated by the WTGs [REDACTED]

[REDACTED]

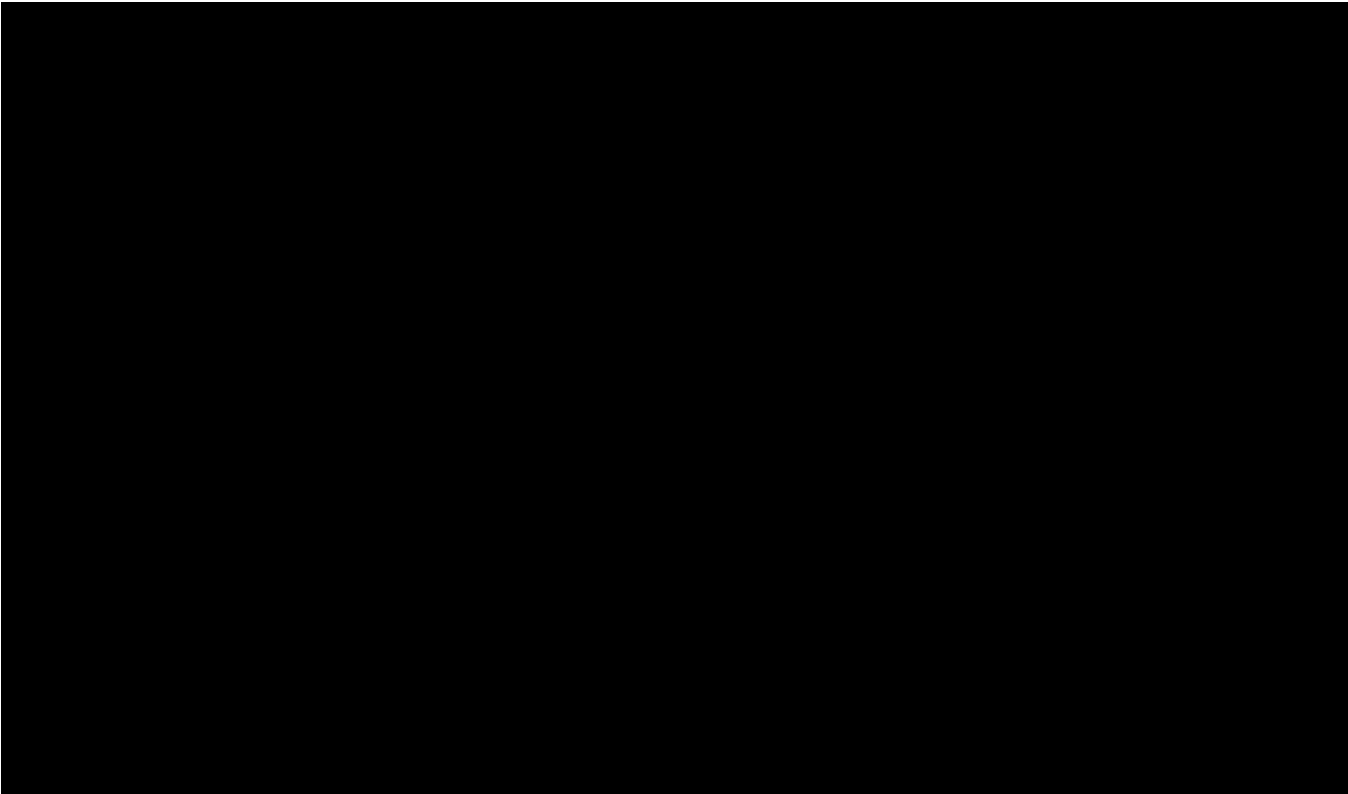
The ESP will be topside (above water) mounted on a jacket foundation, as depicted in **Figure 9.1-5** below.



The jacket foundation for the ESP will be placed at the seabed. Four to six piles will be driven vertically into the seabed, penetrating [REDACTED]

[REDACTED]

The topside will be a conventional steel frame or stretched skin structure with various deck levels, such as the cable deck, main and valve deck, mezzanine or intermediate deck, and roof deck, all designed to house the electrical components. A helideck will likely also be installed to improve operations and maintenance (O&M) workability as well as an escape chute for emergency situations.



The export cables will be protected from external damage using properly engineered burial techniques. Appropriate burial techniques efforts will be evaluated based on potential external damage factors for the cable. These factors include, for example, soil and seabed conditions as well as shipping (i.e. anchoring and fishing) activities taking place in the vicinity of the cable route. Final cable burial techniques and depths burial will be determined based on local conditions, use of the area, and input from local fishermen.

ONSHORE EXPORT CABLE

The offshore export cables will be brought to shore through a buried splice vault located at the landfall site where they will then be connected with the onshore export cable [REDACTED]

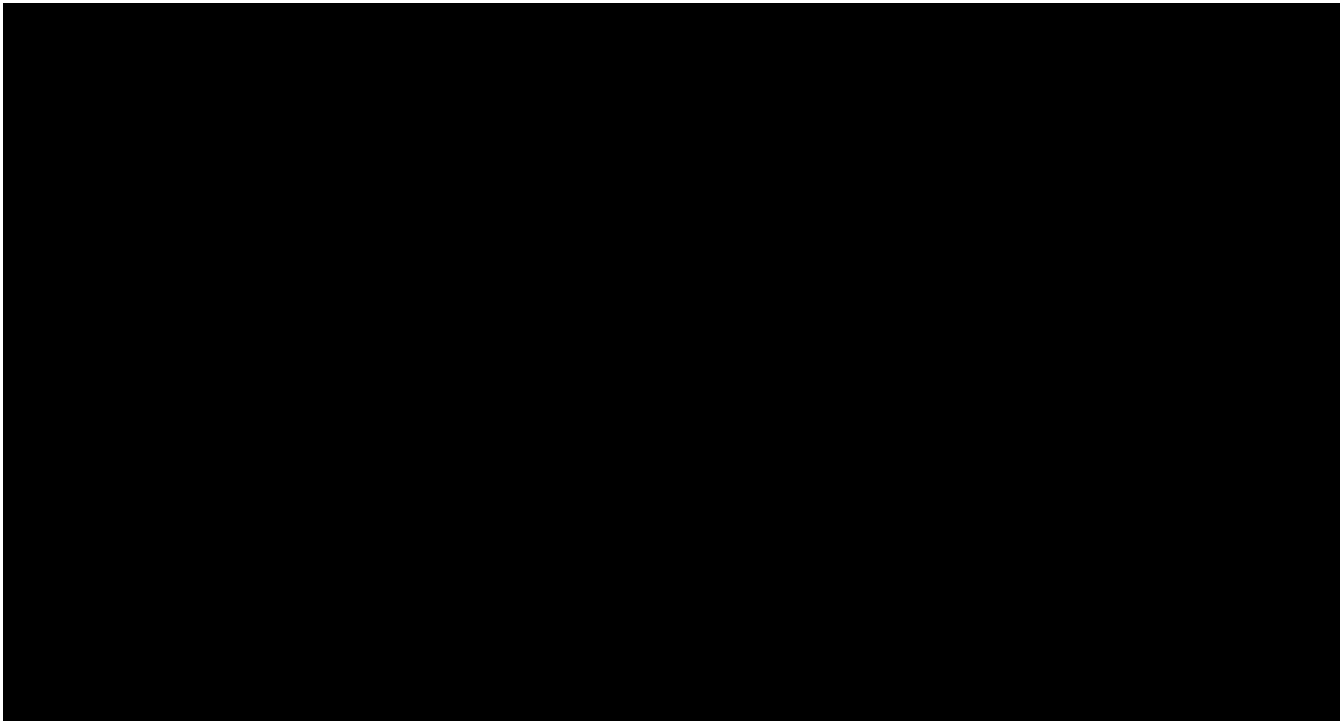
[REDACTED]

[REDACTED]

[REDACTED] The insulation system for the onshore export cable is identical to the insulation system for the offshore export cable. **Figure 9.1-7** illustrates the design [REDACTED]

[REDACTED]

[REDACTED]

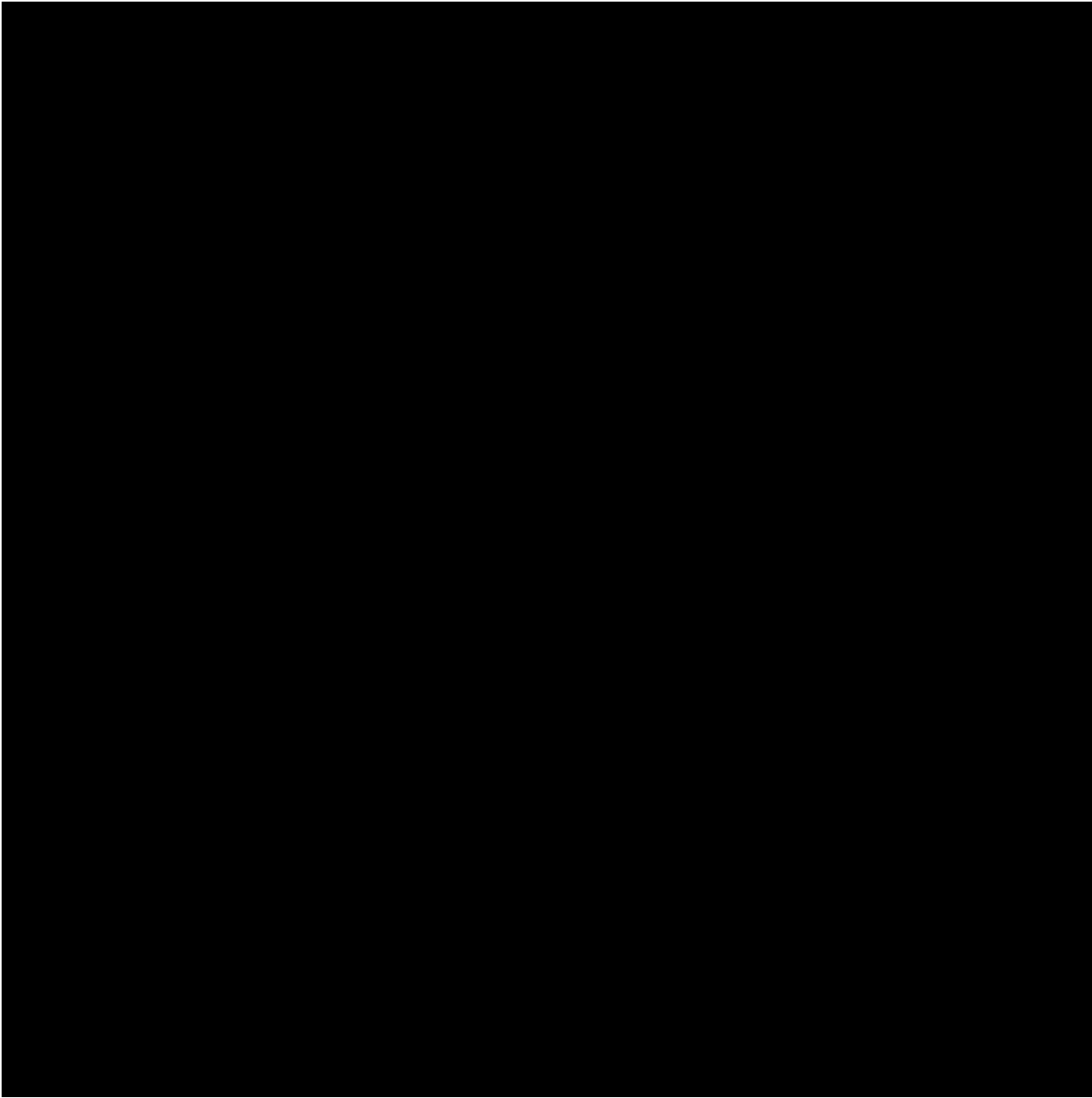


The purpose of the onshore substation is to convert the power received from the onshore export cables [REDACTED]

[REDACTED] Additional measures will be taken with respect to the design of the onshore substation to further minimize any potential acoustic or visual impacts. [REDACTED]

The main electrical components on the onshore substation will be:

- Converter transformers;
- AC switch yard with gas insulated high-voltage switchgear for converter AC-side;
- High frequency AC-side filter;
- AC and DC reactors, DC link capacitors;
- Valve stacks located in a valve hall converting from AC to DC;
- Water to air cooling units for converter water cooling; and
- Service building for protection and control systems.

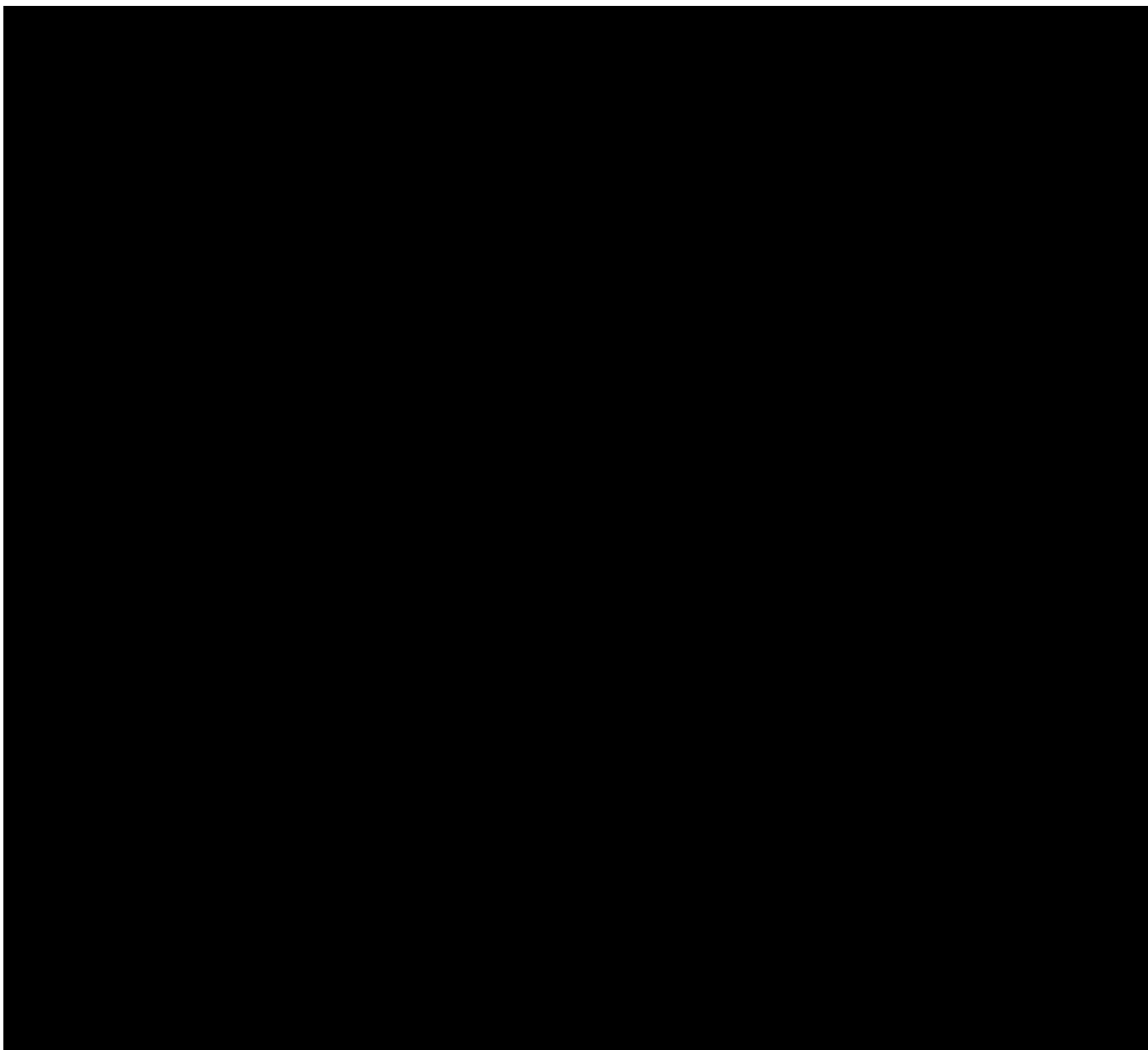


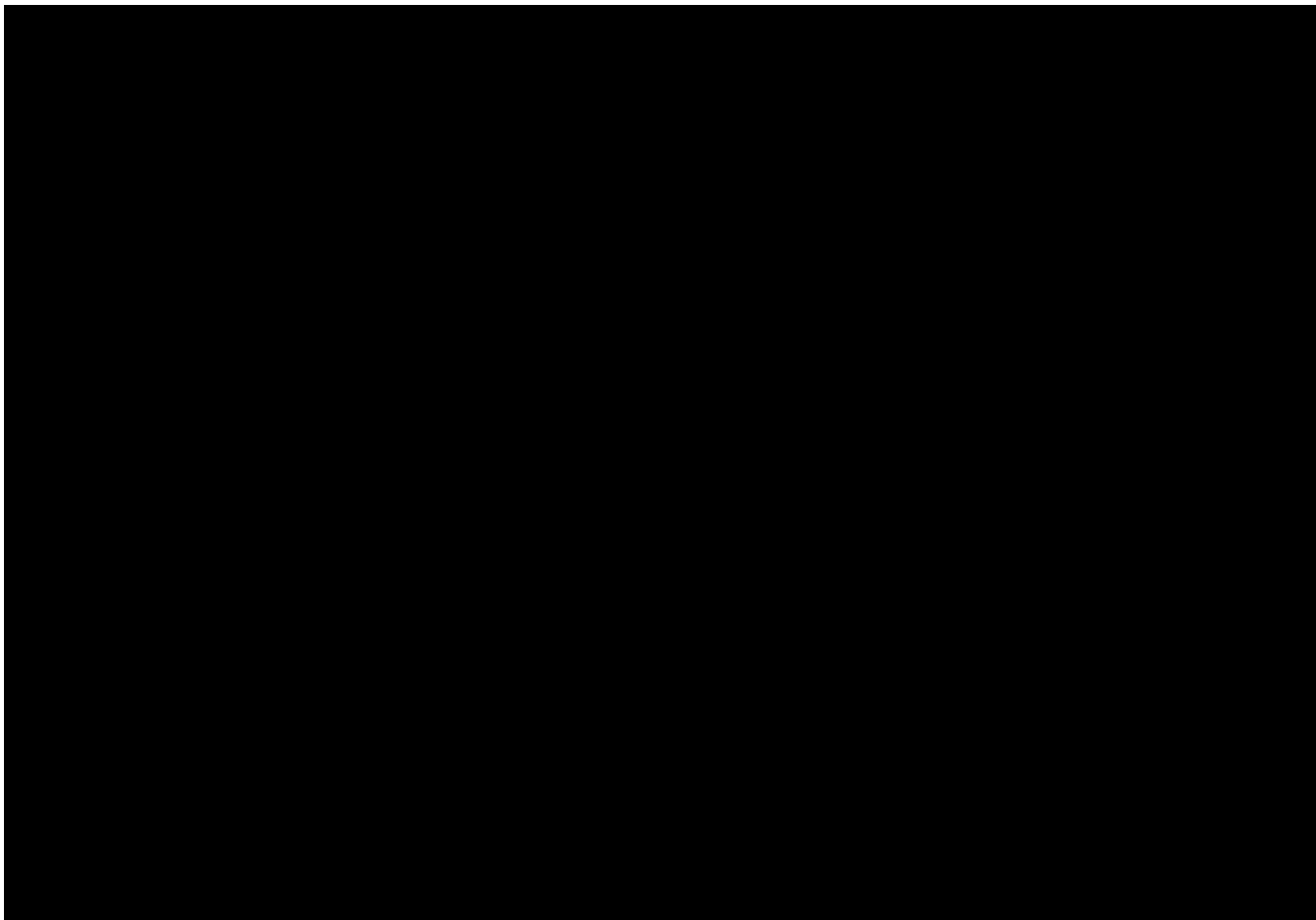
The following section will provide information in relation to:

-
- c. Manufacturer of each of the equipment components as well as the location of where each component will be manufactured*
-

Equipment component manufacturers have not yet been selected for the Project. These manufacturers and their location will be determined as part of the final supplier selection for the Project's individual supply packages.


Table 9.1-1 summarizes potential locations for equipment component manufacturing. It's important to note, however, that this list neither final or exhaustive. As engineering and procurement work for the Project proceeds, additional locations may come into play.






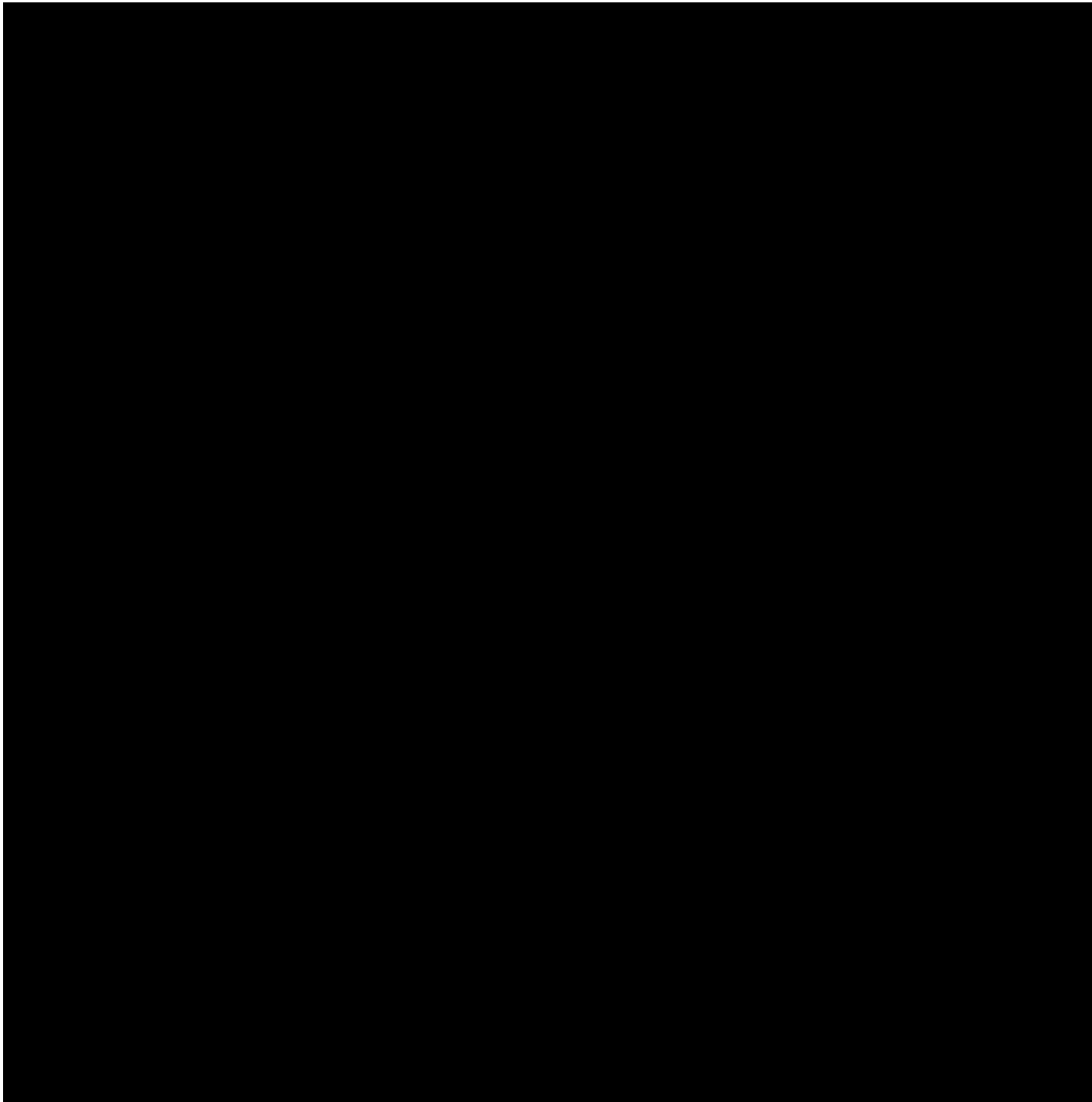
The following section will provide information in relation to:

d. Status of acquisition of the equipment components

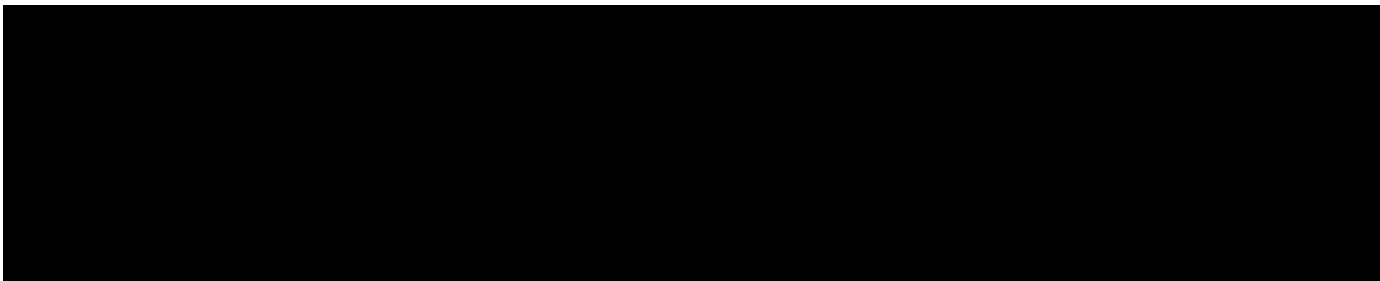
Vineyard Wind began investigating US supply chain capabilities  and is continuously evaluating opportunities in the country's growing domestic supply chain. This provides Vineyard Wind with a solid foundation for procuring components and services in line with the Project schedule outlined in **Section 10**. As already noted, Vineyard Wind has not made yet selected equipment component manufacturers for the Project, which is normal at this stage of the project development process.

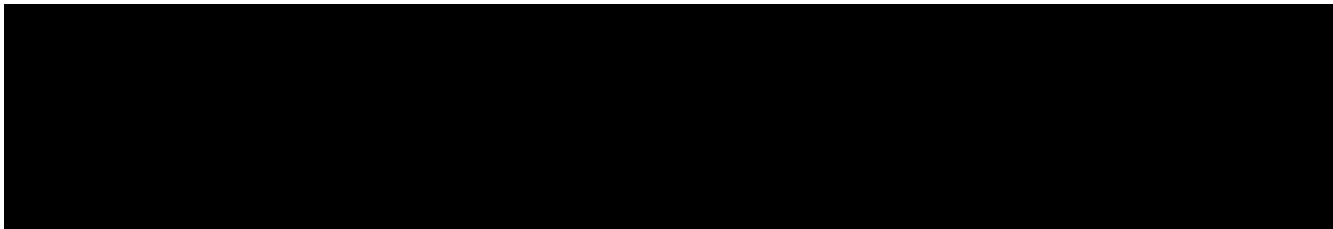


 **Figure 9.1-9** illustrates the different supply packages for the Project as well as the relevant potential component manufacturers and supply chain partners that Vineyard Wind is currently engaging.

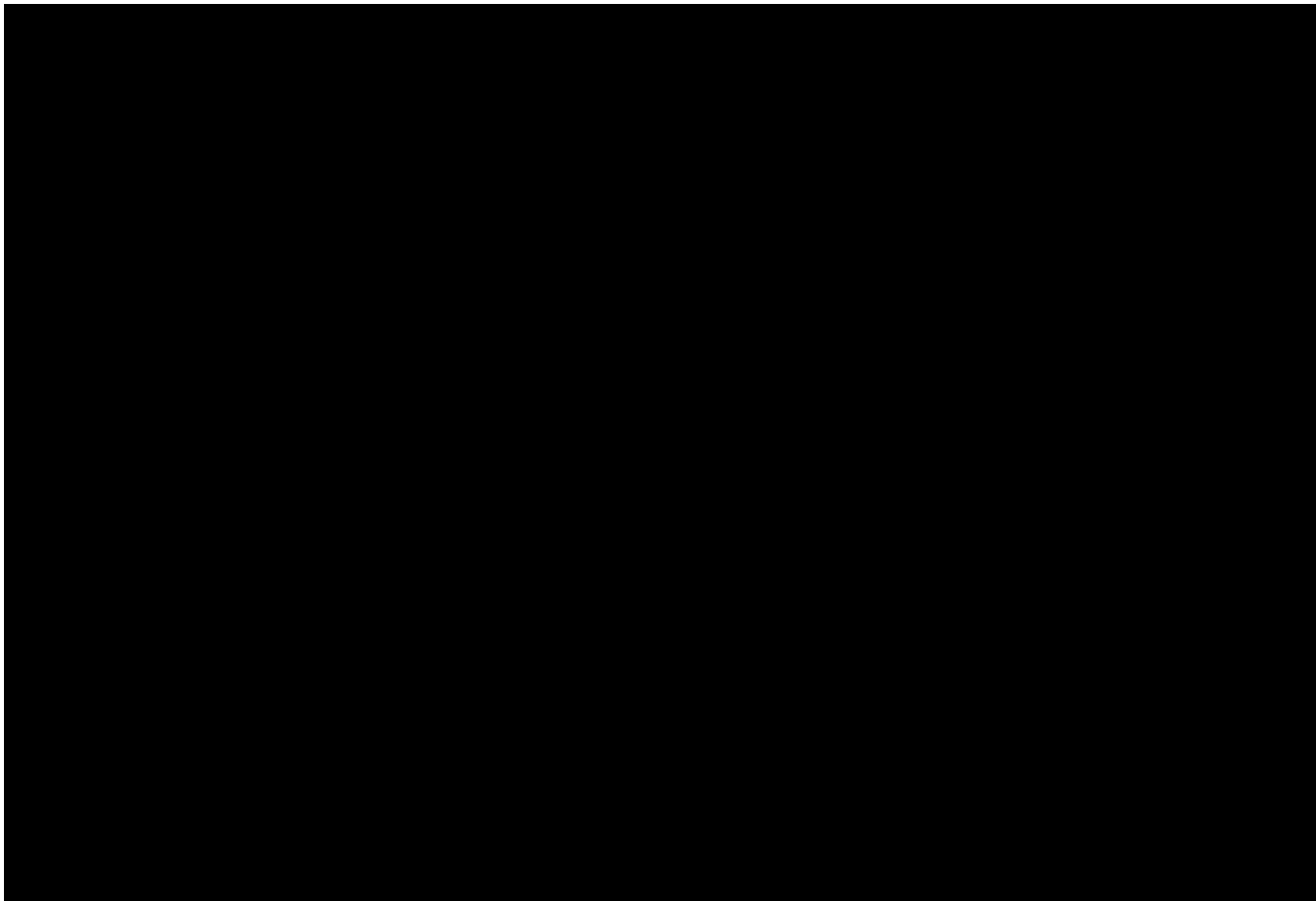


SUPPLY CHAIN INVESTIGATION PHASE







STRUCTURING, TENDERS, AND SUPPLIER PROPOSALS

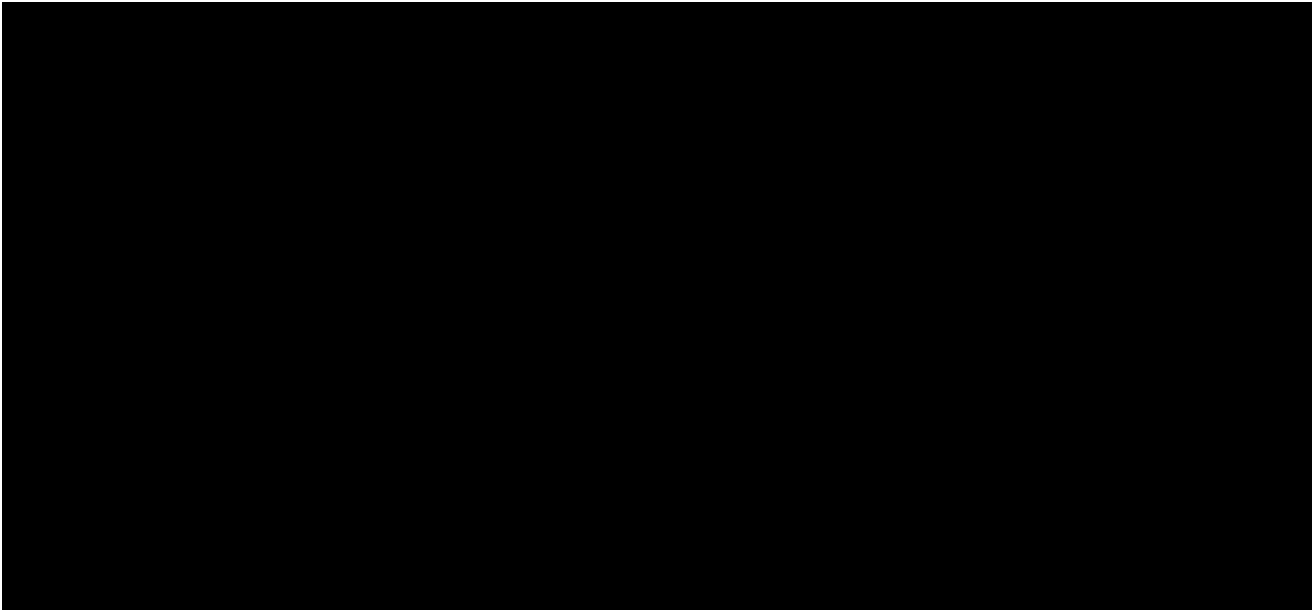






The following section will provide information in relation to:


-
- e. Status of any contracts for the equipment Proposer has or Proposer's plan for securing equipment and the status of any pertinent commercial arrangements*
-

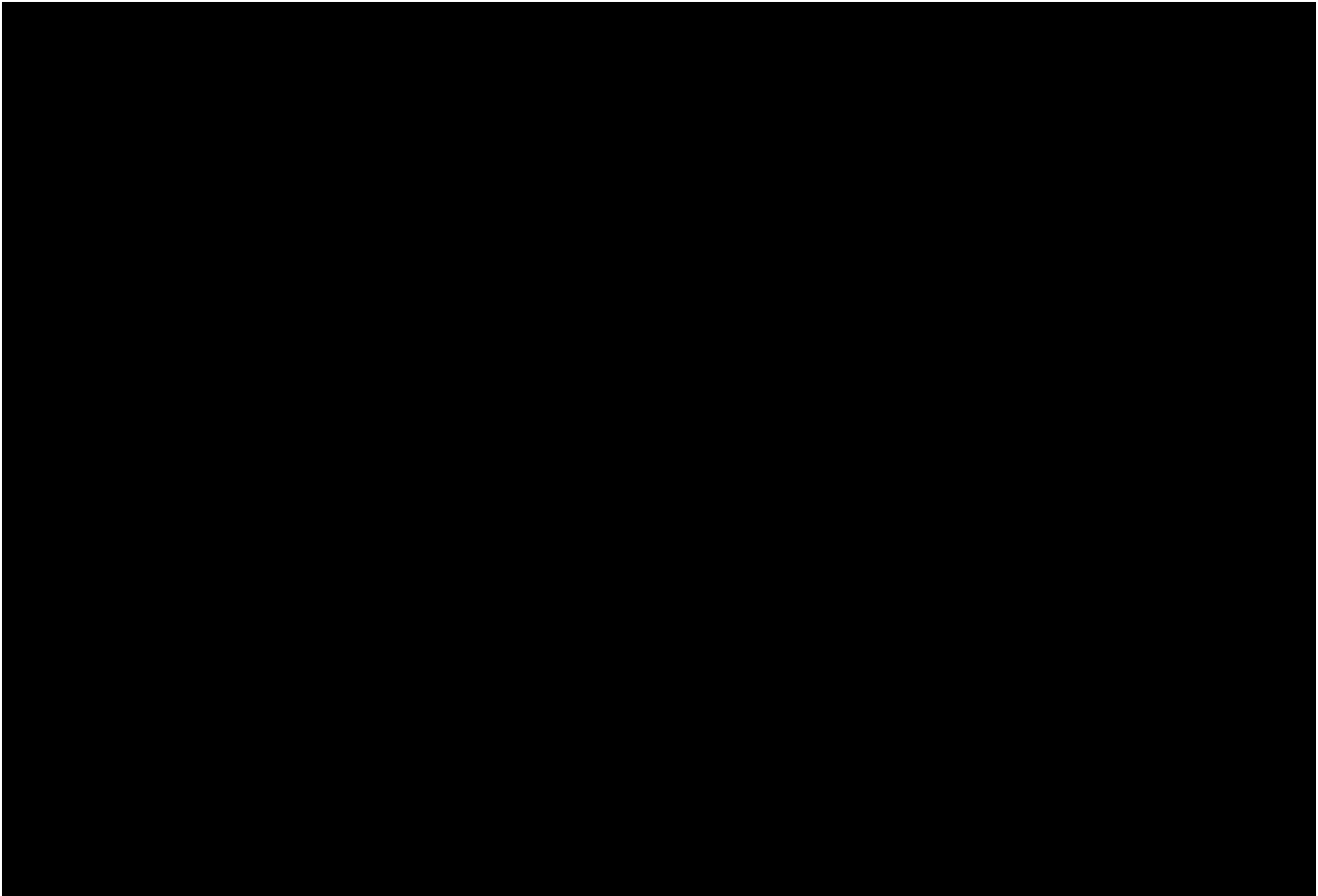
On the basis of the procurement packages overview and the detailed Project schedule set out in **Section 10**, a comprehensive procurement plan, illustrated in **Figure 9.1-11**, has been developed for the Project. 

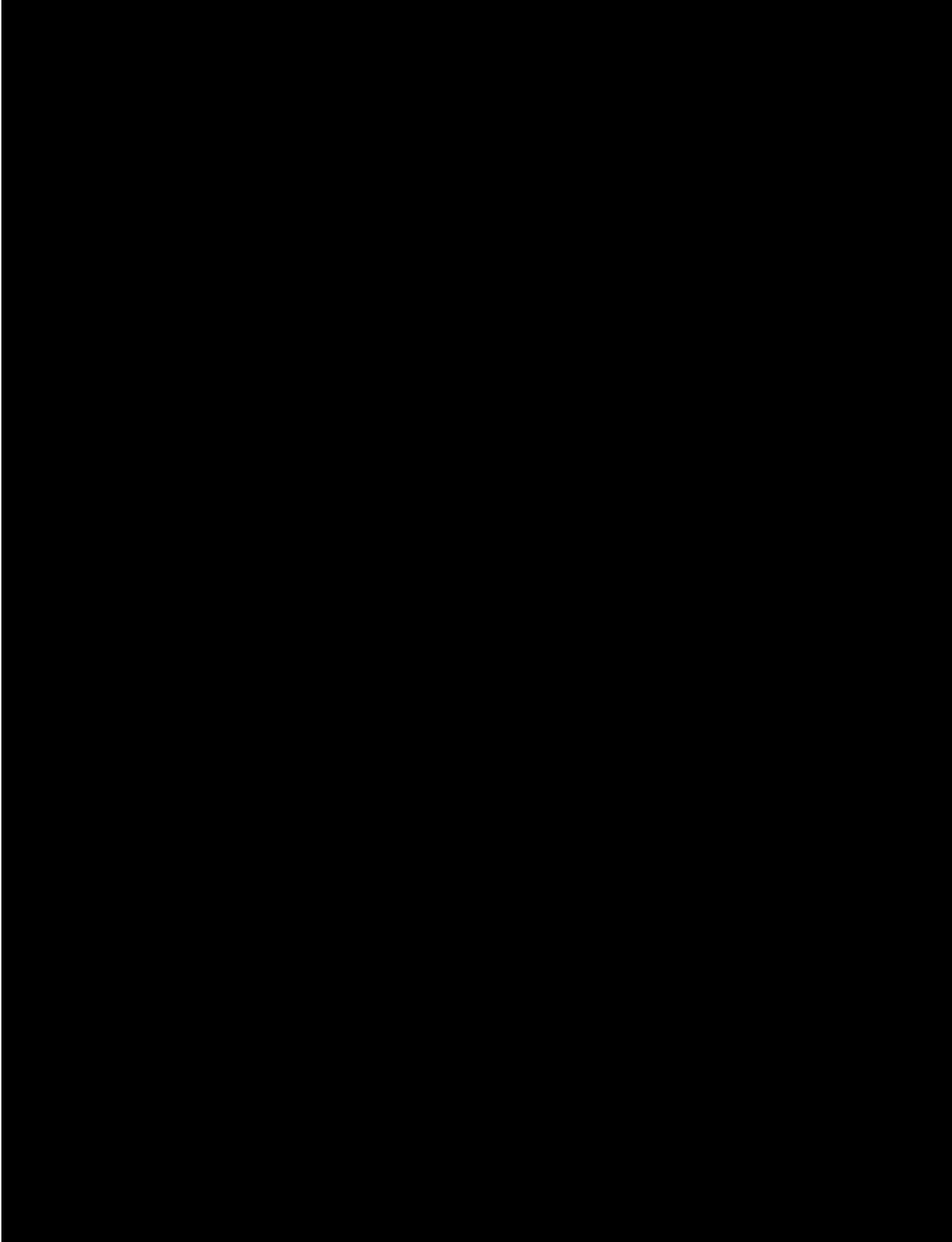
 The procurement timeline takes into account that supplier selections will need to take place in a sequence that includes:

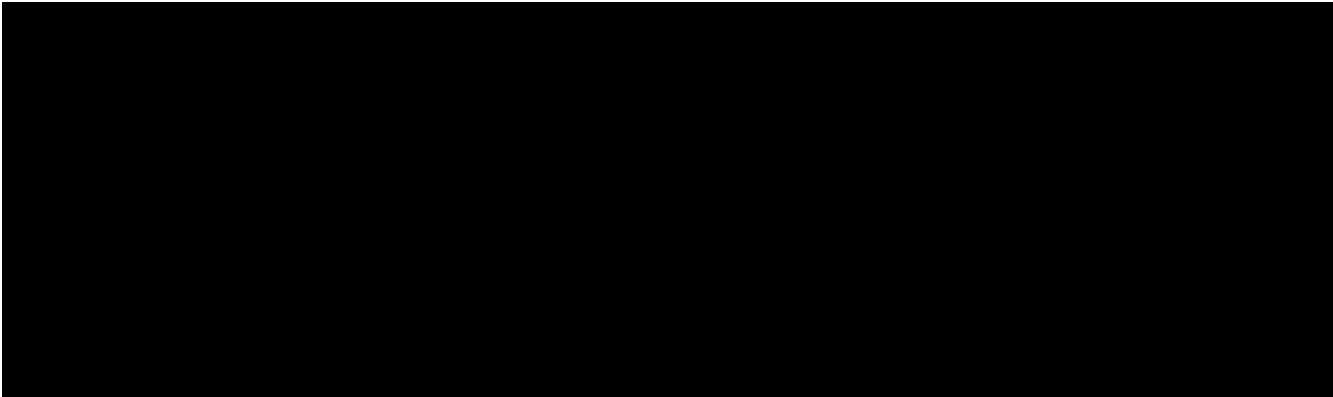


The Project's procurement activities will be structured in several packages. 




 The procurement packages may apply different sourcing processes, but the primary method will be to go to the market in a structured, open, and competitive manner.







The following section will provide information in relation to:

f. Equipment vendors selected/considered

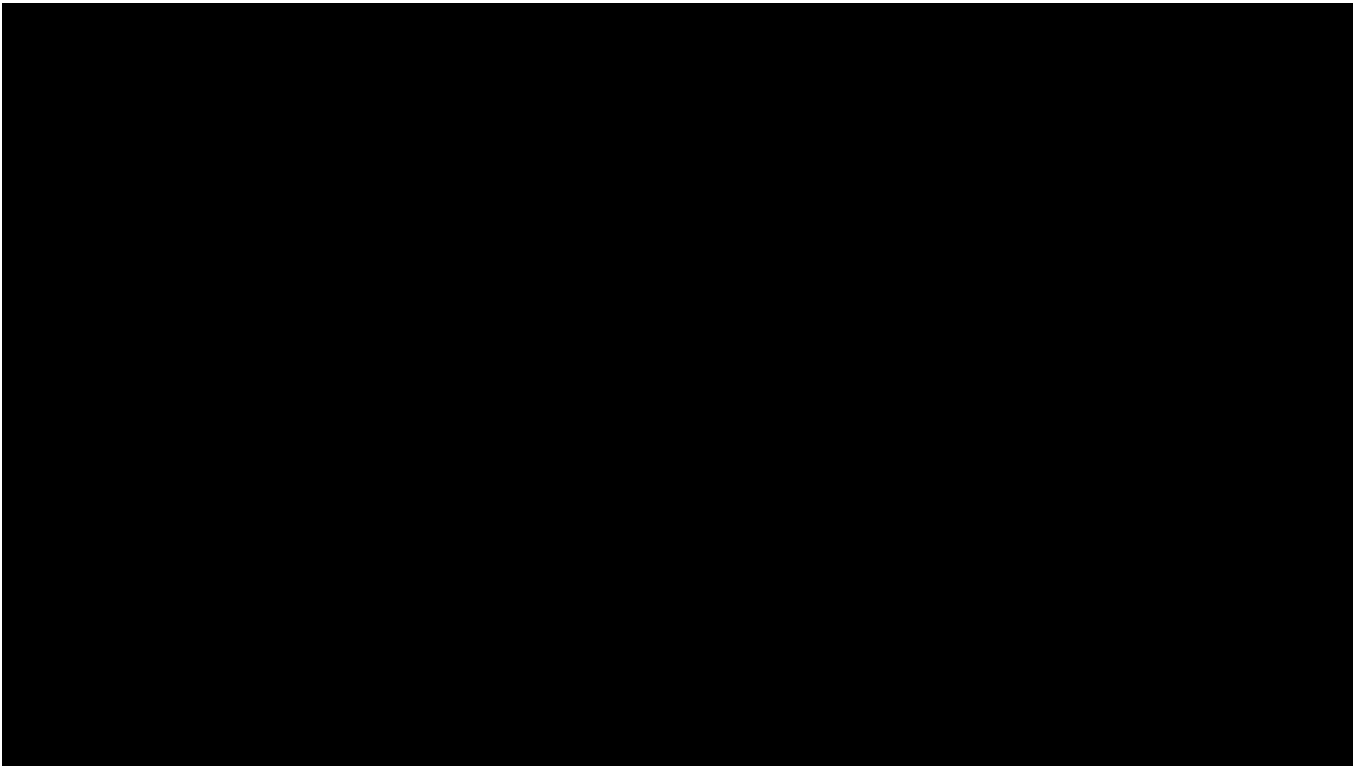
Please refer to the response to **Question 9.1d.** and **Figure 9.1-9.**

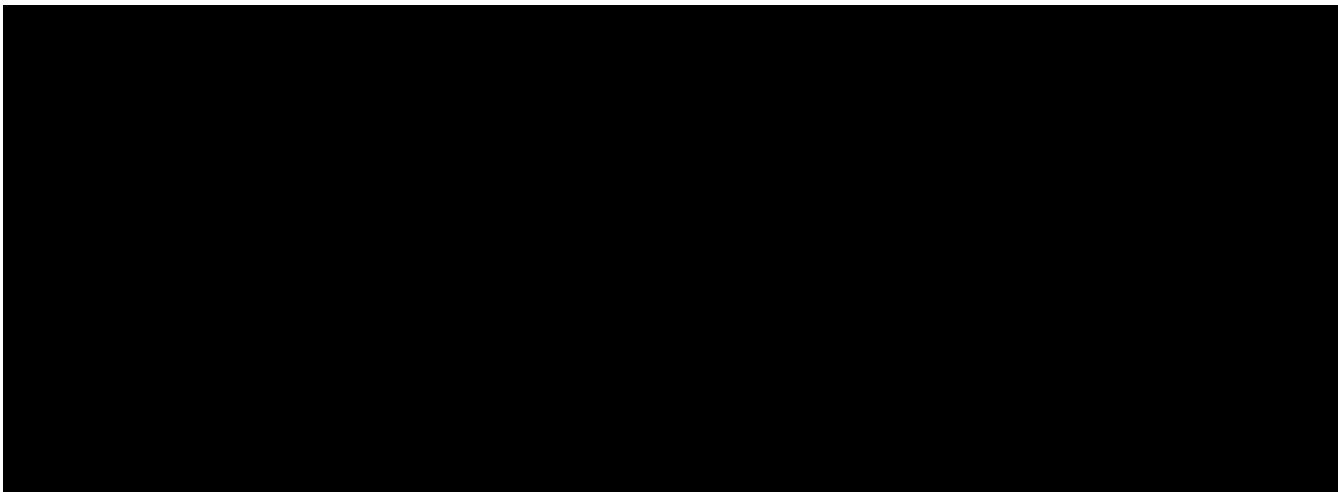
The following section will provide information in relation to:

g. Track record of equipment operations

The operational track record for equipment under consideration by Vineyard Wind is described in greater detail below.

WIND TURBINE GENERATORS





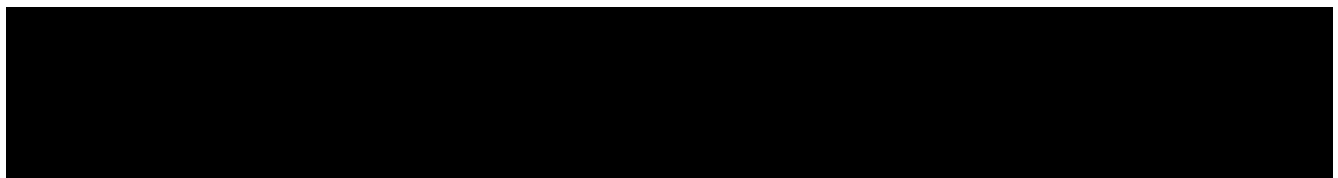
FOUNDATIONS

Monopiles and TPs are proven technical concepts that are currently in use in numerous offshore wind projects worldwide. The first monopile projects were installed in 2000 (Blyth Windfarm, England) & Horns Rev 1 (Denmark, 2002); since then, more than 2,500 monopiles have been deployed in offshore wind projects.



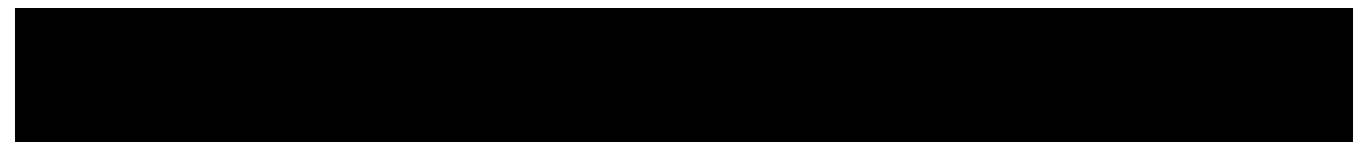
INTER-ARRAY CABLES

Inter-array cables are a well-known technology that have been in use for many years in the wind industry.



ELECTRICAL SERVICE PLATFORMS

ESPs with offshore HVDC converters are expanding and maturing rapidly. Currently, 40 of the over 90 offshore wind farms in Europe have a nameplate capacity (intended full-load sustained output) higher than 200 MW and roughly one-third of these are connected to the grid by HVDC transmission, individually or in groups. So far, there are seven HVDC offshore wind connection systems in operation and another three under construction.





[REDACTED]. In addition, the ESP for the Project will be designed by an experienced EPC(I) contractor; all suppliers are expected, and will be encouraged, to design the ESP based on well-known and proven concepts; the contractors that will be invited to bid on the Project will include very experienced contractors, and the ESP design will benefit from their many years of experience.

EXPORT CABLES

[REDACTED]
[REDACTED] Such cables are used worldwide for HVDC power transmission systems.

ONSHORE SUBSTATION

[REDACTED]
[REDACTED]
[REDACTED]


[REDACTED] onshore substation's electrical design will be based on the overall electrical system for the Project, and is considered to be a well-known and proven concept. There are many experienced contractors in the Northeast, and across the US, who have the required expertise to build an onshore substation for the Project.


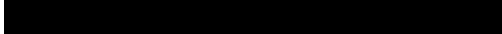
The following section will provide information in relation to:


-
- h. Design considerations (technology selection, layout) for climate adaptation and resiliency such as sea level rise, potential impacts from increased frequency and severity of storms (i.e. superstorms, hurricanes), seismic activity, etc.*
-

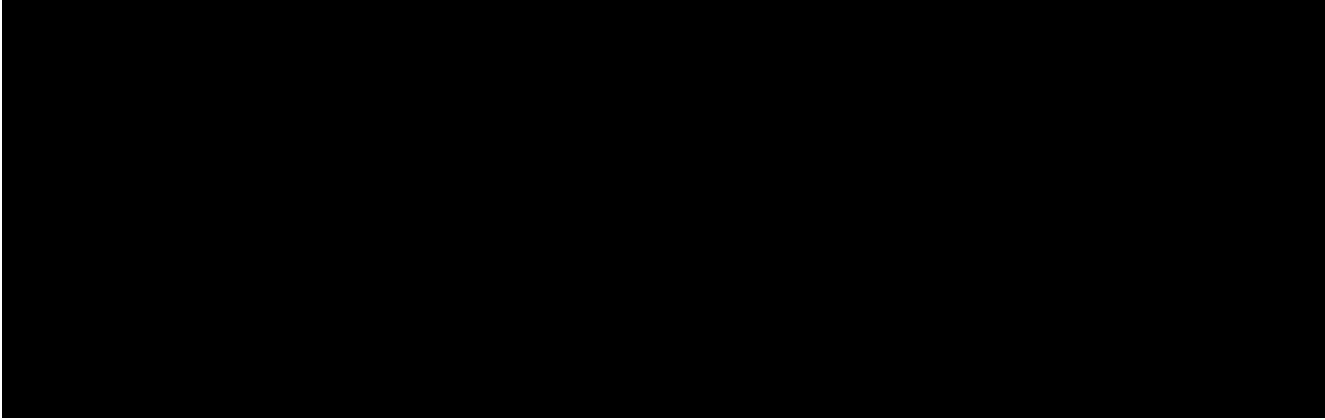
Climate adaption and resiliency related to sea level rise and the increased frequency and severity of storms are factors that Vineyard Wind has taken into account through the use of best-in-class design standards, [REDACTED]

Requirements related to climate adaptation and resiliency to extreme weather events can be found in IEC 61400-3 (and its draft update IEC 61400-3-1) for the IEC framework, and in DNVGL-ST-0437 for the DNV GL framework.

The Project' design will be certified according to the standards above, by an independent and accredited, third party as was done for Vineyard Wind's first 800 MW project. 

While the Project's design standards and methods are the same as for other modern offshore wind projects, the environmental conditions for the specific site (e.g., sea level rise, severity and frequencies of hurricanes and nor'easters, etc.) need to be assessed using information relevant to the site. 





The following section will provide information in relation to:

-
- i. In the event the equipment manufacturer has not yet been selected, identify in the equipment procurement strategy the factors under consideration for selecting the preferred equipment as well as the anticipated timing associated with the selection of the equipment manufacturer, including the timing for binding commercial agreement(s).*
-

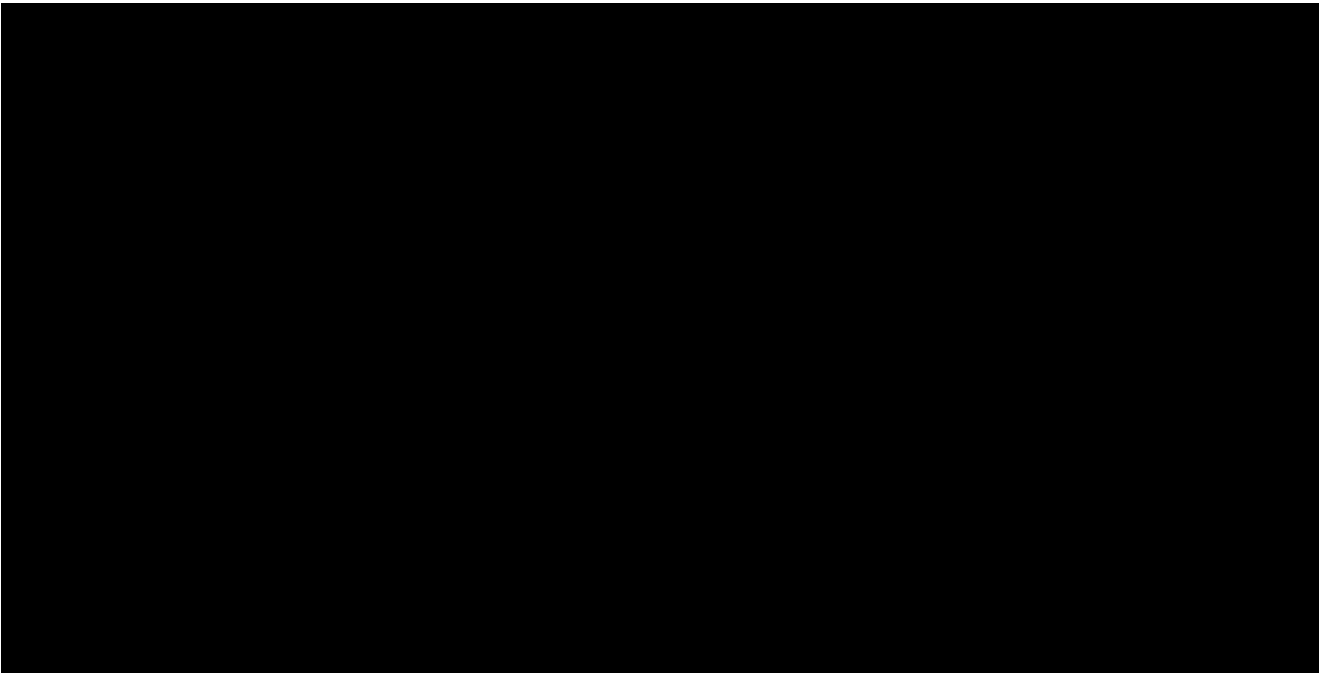
As mentioned previously, Vineyard Wind has not yet secured equipment for the Project, which is normal at this stage of the project development process. Procurement will be initiated following NYSERDA's contract award and will be concluded before financial close [REDACTED]

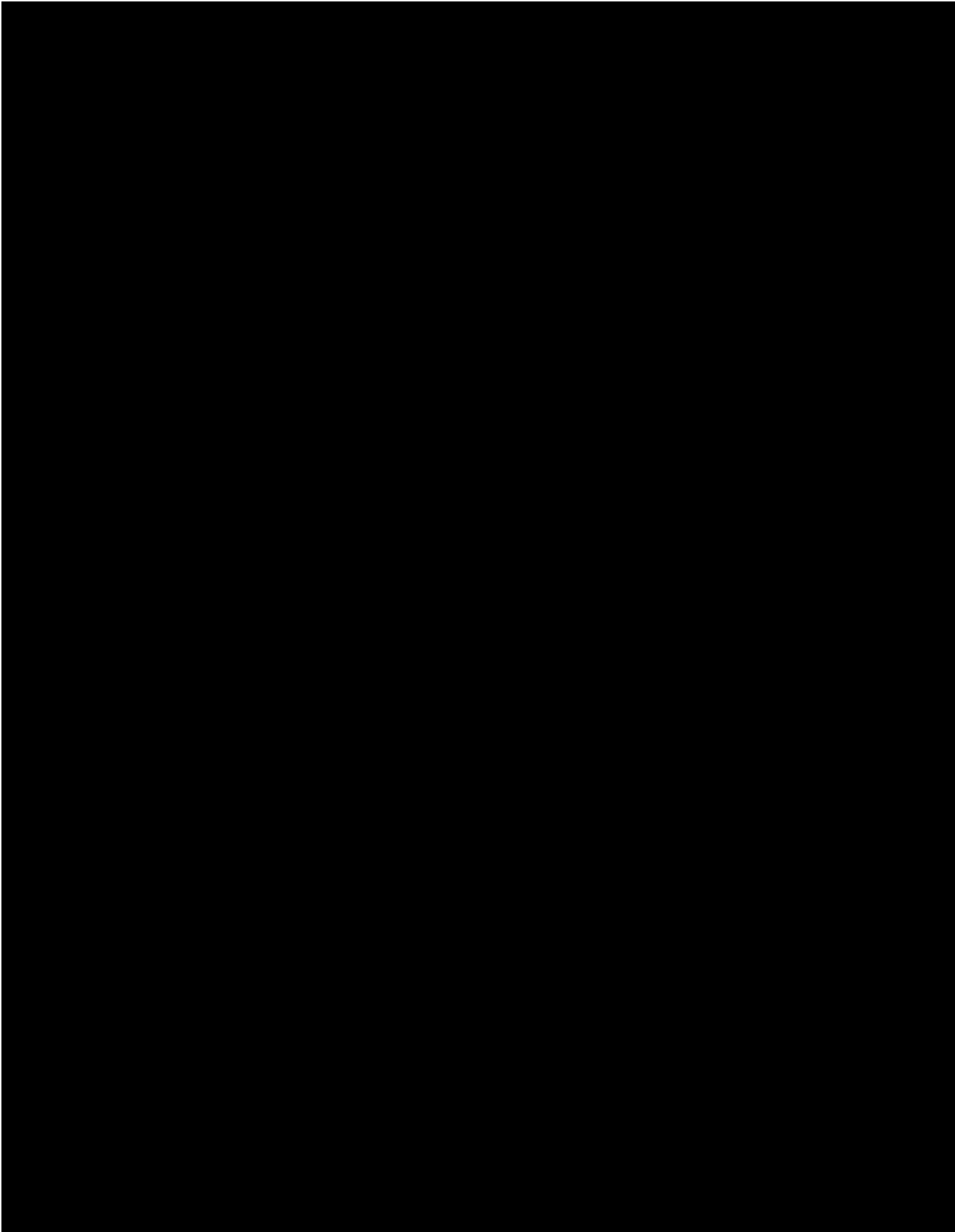
The Project's procurement packages and activities are outlined in **Figure 9.1-10** and the anticipated timing of manufacturer selection is illustrated in **Figure 9.1-11**.

The Project's engineering and procurement plan has been prepared in full and takes into account lead times for all long-lead equipment such as:

- HVDC converters;
- Electrical equipment for the substations;
- Steel for the manufacturing of ESP and foundations;
- Export cables; and
- Design lead times, especially on the foundations and the ESP.

Table 9.1-2 below outlines key factors that will be considered when procuring equipment for the Project.







The following section will provide information in relation to:

9.2 *Describe the lighting controls that will be utilized on the Offshore Wind Generation Facility and explain how these controls comply with the minimum contract standards and the Offshore Wind Order.*

The Offshore Wind Generation Facility, including any lighting, will not be visible from any location in New York and will extremely limited visibility from other locations see **Section 15**). The marine navigation and lighting controls proposed for the Project, described below, further reduce lighting-related visual impacts and minimize risk to avian species to the greatest extent possible.

[REDACTED]

[REDACTED]

[REDACTED]

[REDACTED] The lighting controls

therefore fully comply with the minimum contract standards and the Offshore Wind Order

The final, approved lighting scheme for the Offshore Wind Generation Facility will be determined through the Project's permitting process, in consultation with BOEM and the US Coast Guard (USCG).

Construction Phase Lighting Controls

During the Project's construction phase, lighting controls will be in place for the WTGs, ESPs, and onshore staging areas. Lighting may be required on installations vessels over a certain height. All lighting controls will be installed in accordance with federal standards.

For the Offshore Wind Generation Facility, lighting is required on the WTGs once they reach a height of 200 ft or greater until the permanent lighting configuration is activated [REDACTED]

[REDACTED]

[REDACTED]

[REDACTED]

[REDACTED]

[REDACTED]

All Project-related vessels, equipment, and appurtenances will display the required navigation lighting.

Operations Phase Lighting Controls

During the Project's operations phase, the Offshore Wind Generation Facility will be equipped with aviation and marine navigation lighting controls. [REDACTED]

[REDACTED]


[REDACTED]

[REDACTED]



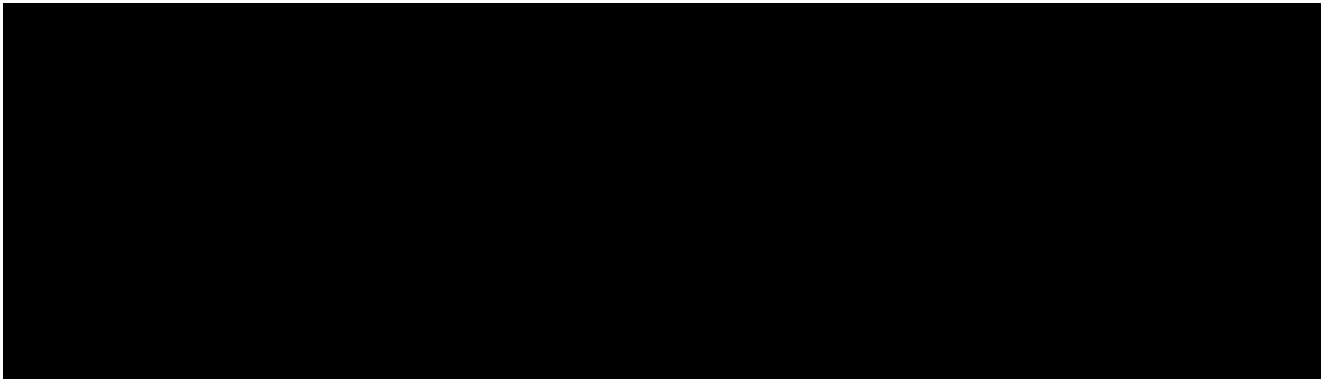
Aviation Lighting


All WTGs will include a night-time wind turbine obstruction lighting system consisting of two synchronized FAA “L864” aviation red flashing obstruction lights placed on the nacelle of each WTG.




Marine Navigation Lighting

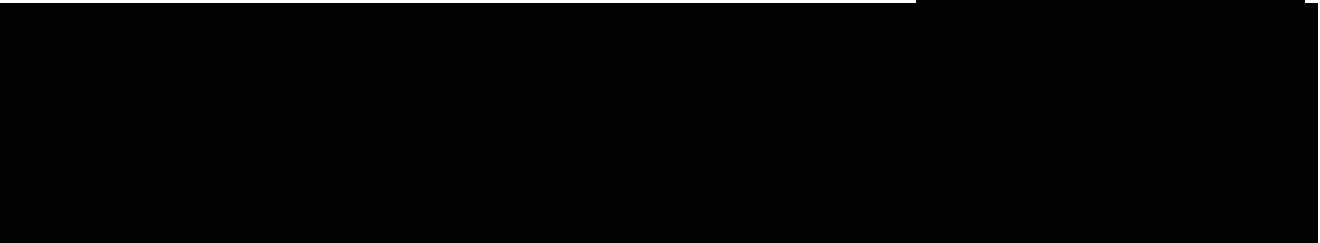
The WTGs and the ESP will also have lighting specific to marine navigation. The final navigation and lighting equipment, configuration, and intensity will be determined through consultations with the BOEM and the USCG.



 Installed lighting intensity and flash sequence will be determined in consultation with the USCG.

Minimizing Risk to Wildlife

Avian species are those most at risk, i.e., likely to be attracted to the WTGs, by lighting. Much of that risk has been avoided due to the Project’s location far offshore. To further minimize the risk and potential bird mortality from collision with WTGs, the Project will reduce lighting as much as practicable during the Project’s construction and operations phases. 







LIBERTY WIND

SECTION 10 - PROJECT SCHEDULE

Proposal for New York State Energy Research and Development Authority in response to Request For Proposals for Purchase of Offshore Wind Renewable Energy Certificates







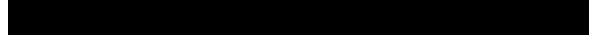
Photo: Beatrice offshore wind farm

SECTION 10 OF APPENDIX B TO THE RFP
PROJECT SCHEDULE

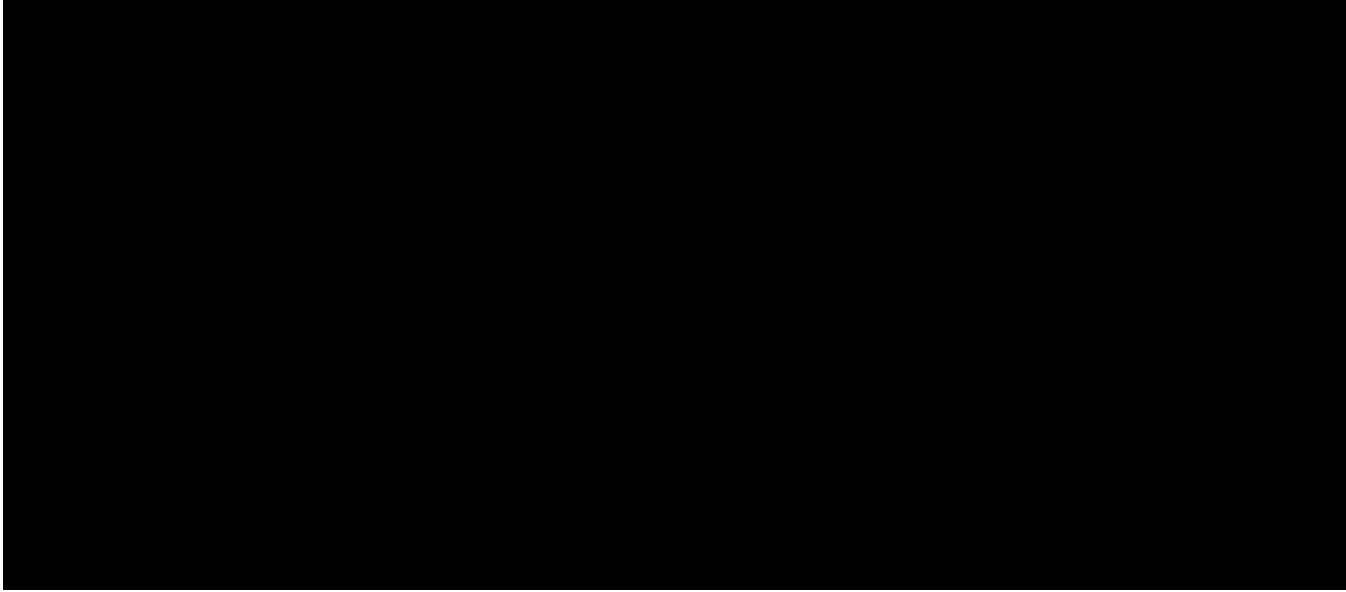
Proposers are required to provide a critical path schedule for the Project from the notice of award to the start of commercial operations. For each Project element listed below provide the start and end dates:

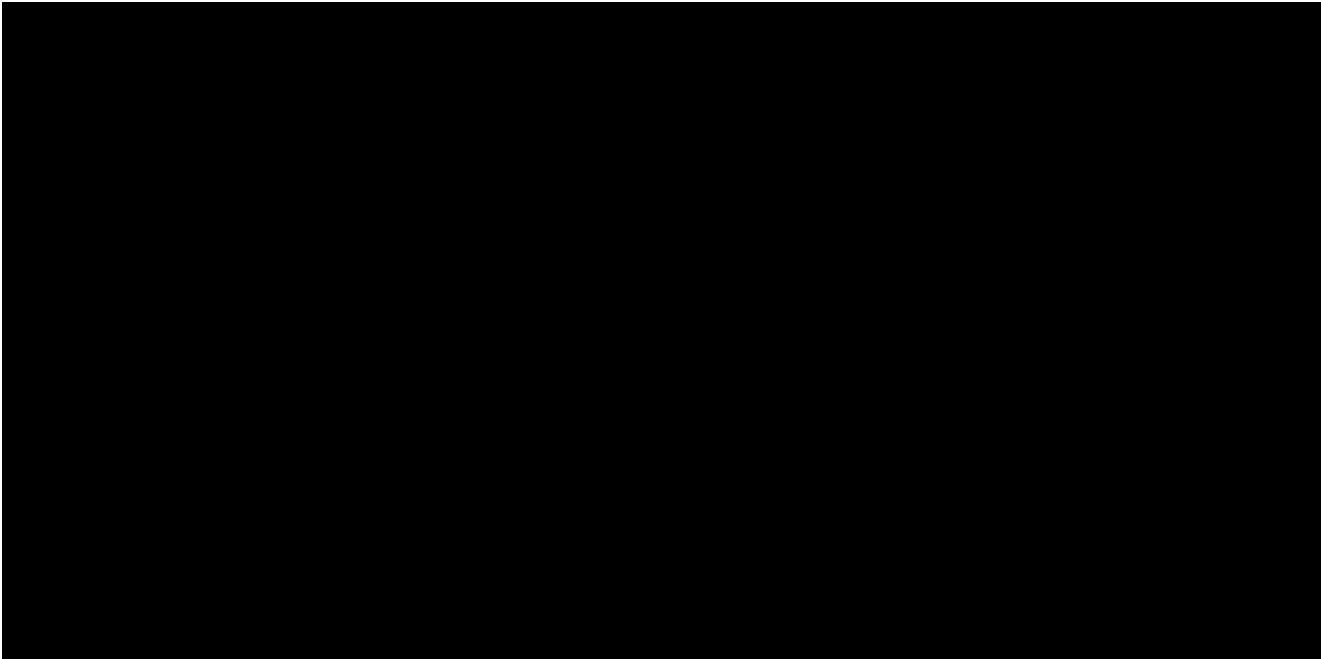
- 10.1 Identify the elements on the critical path. The schedule should include, at a minimum, preliminary engineering, financing, acquisition of real property rights, Federal, state and/or local permits, licenses, environmental assessments and/or environmental impact statements (including anticipated permit submittal and approval dates), completion of interconnection studies and approvals culminating in the execution of the Interconnection Service Agreement, financial close, engineer/procure/construct contracts, start of construction, construction schedule, and any other requirements that could influence the Project schedule.*
-

OVERVIEW

Vineyard Wind is proposing to construct Liberty Wind (the “Project”). 





Liberty Wind’s planning approach is based on the substantial experience that Vineyard Wind and Vineyard Wind’s parent companies have gained in US and international offshore wind development. The Project stands to benefit significantly from the insights and learnings Vineyard Wind has acquired while developing what will be the nation’s first commercial-scale offshore wind project.





KEY MILESTONES ACHIEVED

[REDACTED]
[REDACTED]
[REDACTED]. Vineyard Wind's first 800 MW project has maintained and achieved all of the original milestones and continues to be on track for its planned construction and operation. [REDACTED]
[REDACTED]
[REDACTED]
[REDACTED]
[REDACTED]
[REDACTED]
[REDACTED]

[REDACTED]
[REDACTED]
[REDACTED]
[REDACTED]
[REDACTED]
[REDACTED]
[REDACTED]
[REDACTED]

[REDACTED] Finally, the Project's detailed schedules will permit the team to coordinate activities, monitor schedule performance, and analyze the impact of changes and adjustments to the Project during planning and execution.

PROJECT SCHEDULE AND CRITICAL PATH

The Project schedules presented herein have been developed using the extensive experience of Vineyard Wind's parent companies and members of the Project team. [REDACTED]

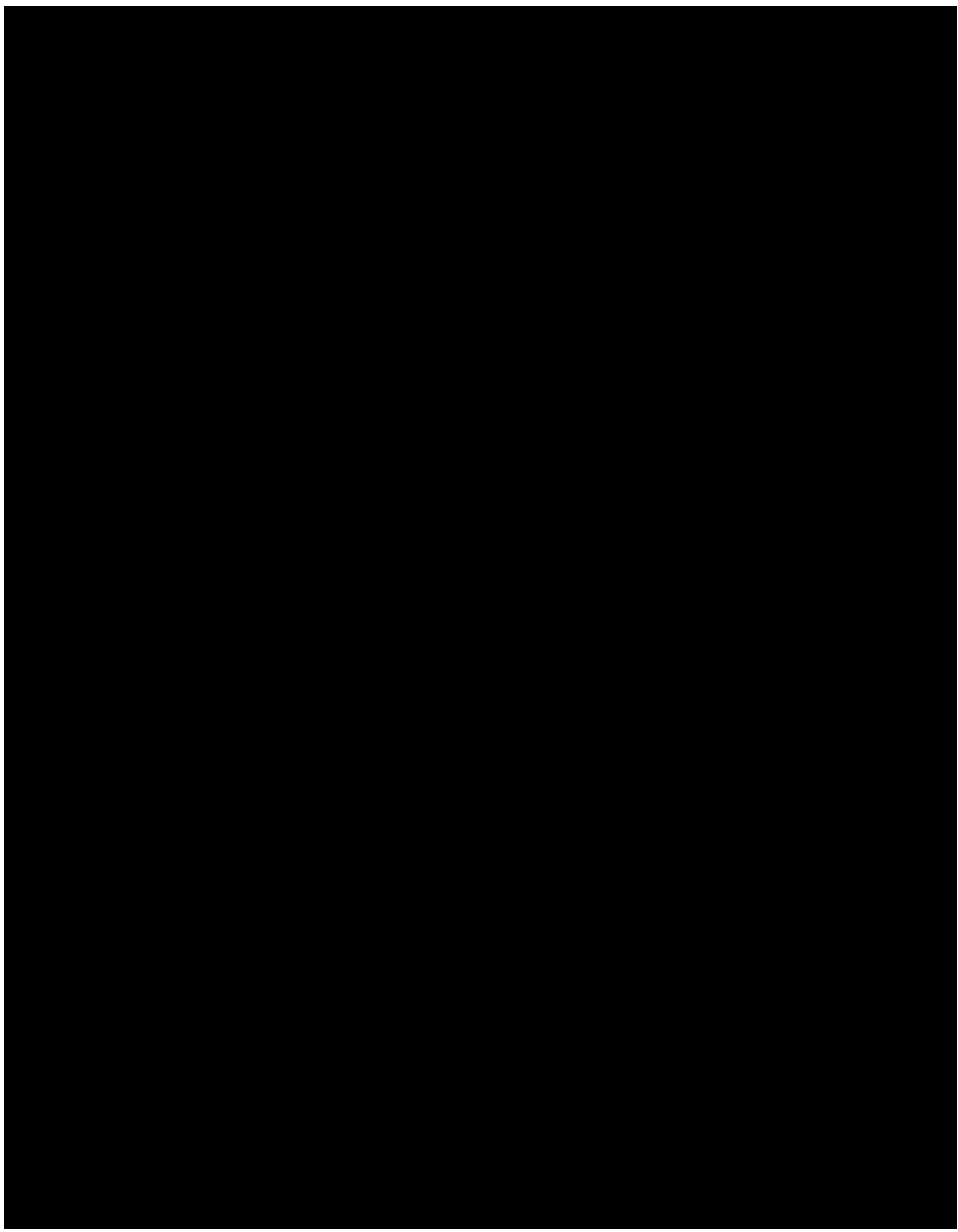
[REDACTED]

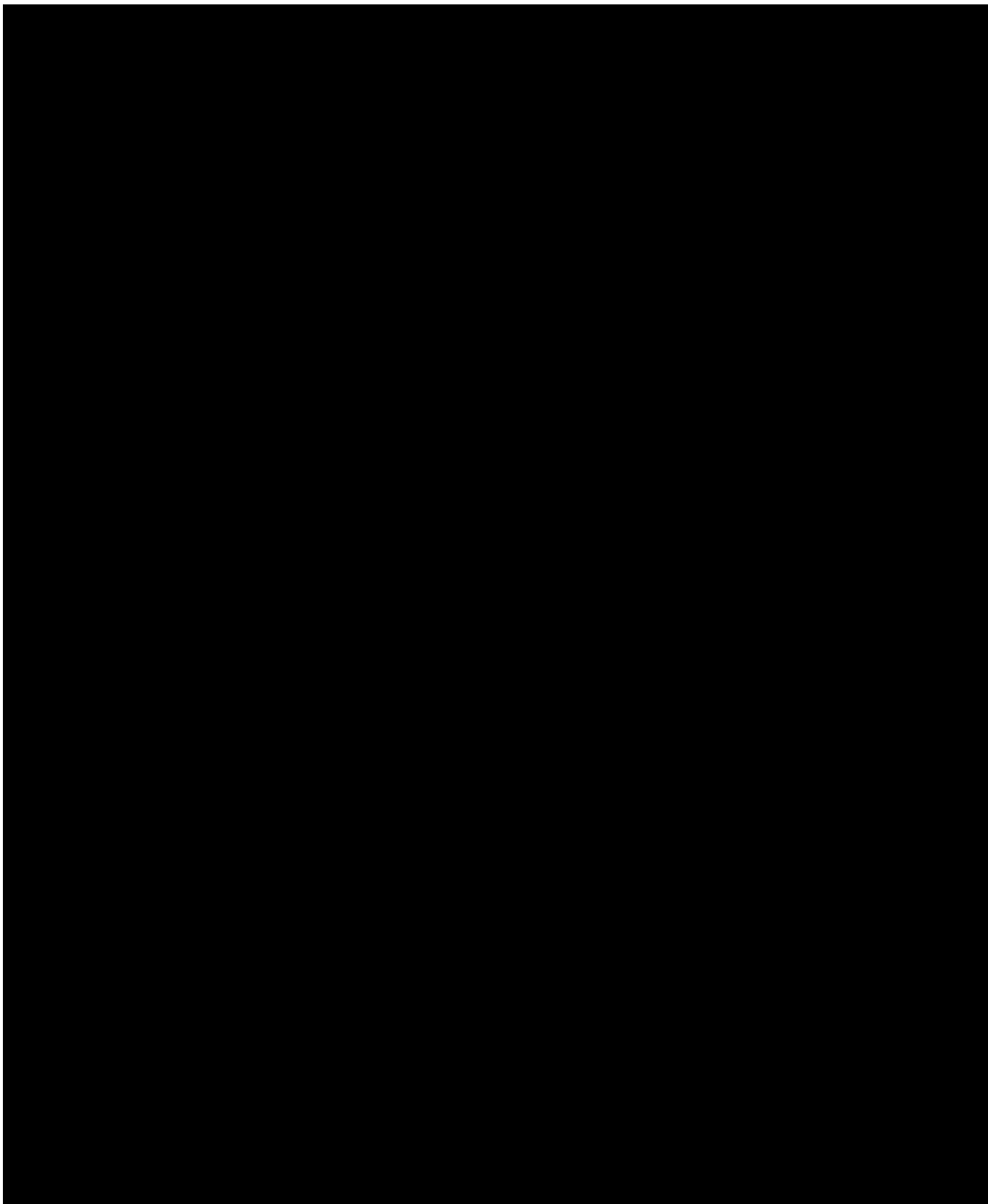
In developing the Project's schedules and critical path, Vineyard Wind first identified the critical steps and work streams for Project execution and then mapped out the key activities to deliver the Project in accordance with the key milestones. The following subsections describe high-level Project schedules together with a list of the critical activities for the Project. Each schedule shows the main activities and their alignment. [REDACTED]

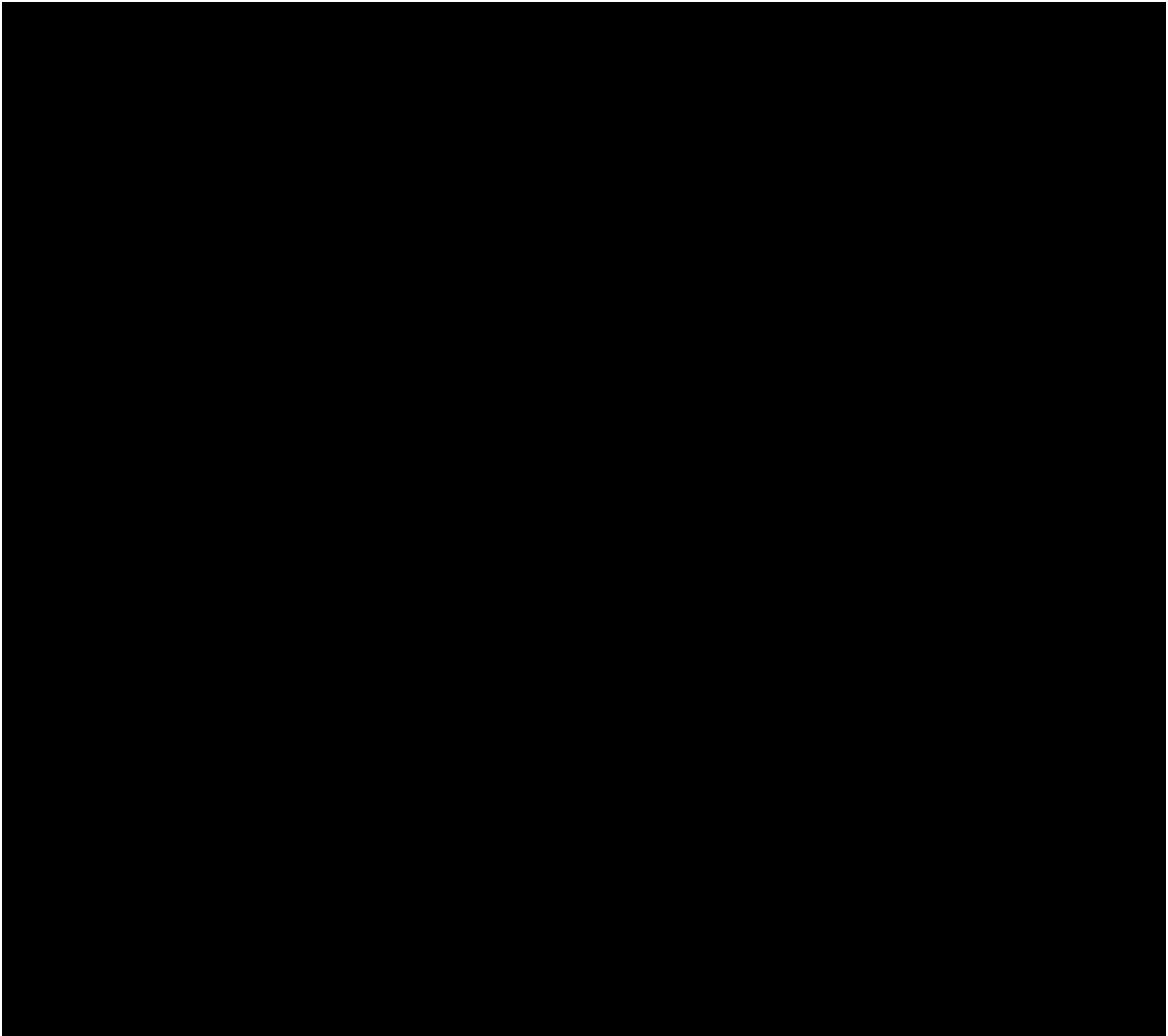
[REDACTED]

[REDACTED]

[REDACTED] detailed schedule for the Project is included as **Attachment 10.1-1**.







CRITICAL ACTIVITIES

Critical Path Analysis


[REDACTED]


[REDACTED] Vineyard Wind is therefore confident that the Project's schedule is achievable, and the Project will be delivered as planned. Three key activities are on the Project's critical path:


[REDACTED]

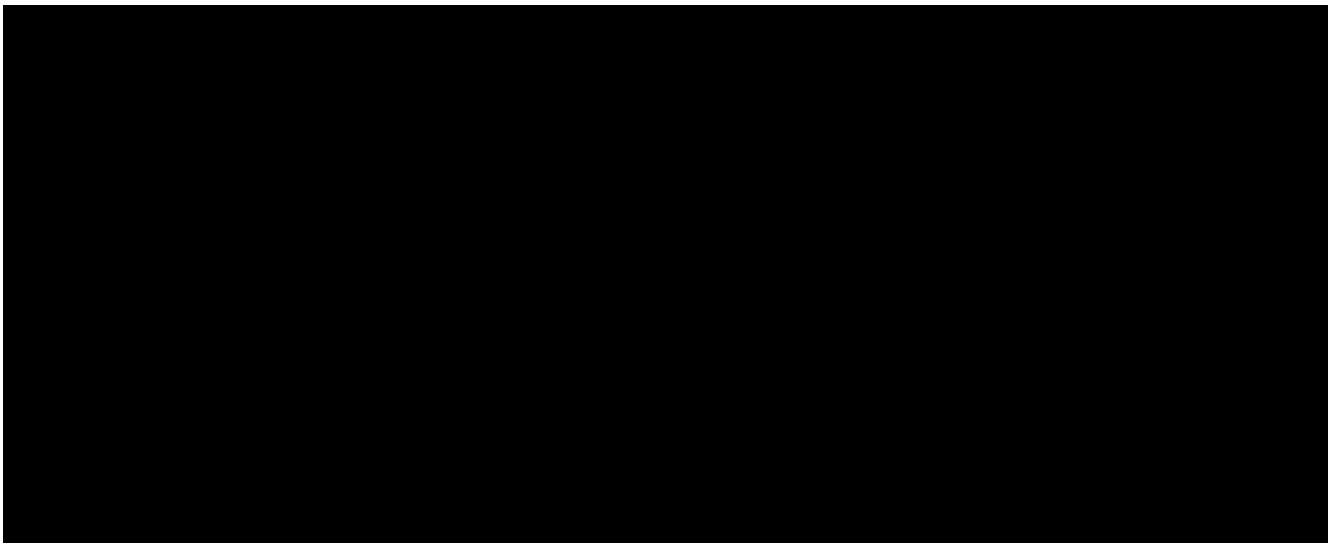
Vineyard Wind its parent companies are confident that the Project's schedule is robust and achievable given the critical path activities described above. This assessment is based on their extensive experience and a successful track record managing the execution of projects of similar scope and magnitude.

10.2 Describe the anticipated permissible offshore construction windows, and how the construction and how the construction milestones will be accommodated within these windows.

Based on experience with the first 800 MW project, a new assessment of permissible construction windows was completed. 

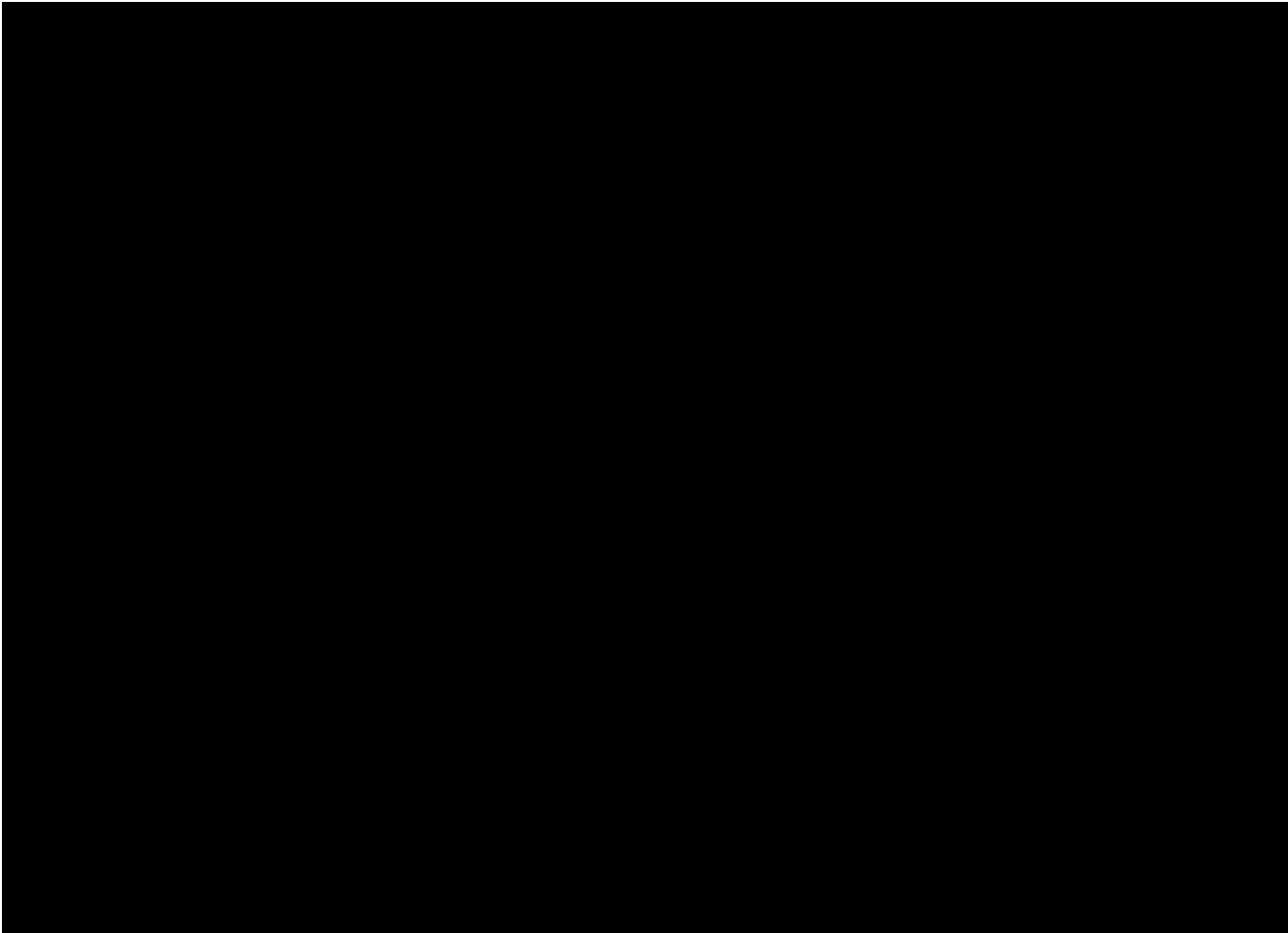
 Final permissible offshore and onshore construction windows for the Project will be determined by in consultation with federal and state agencies, and with input from relevant stakeholders.

The restricted offshore construction window for piling operations that Vineyard Wind identified covers the entire 



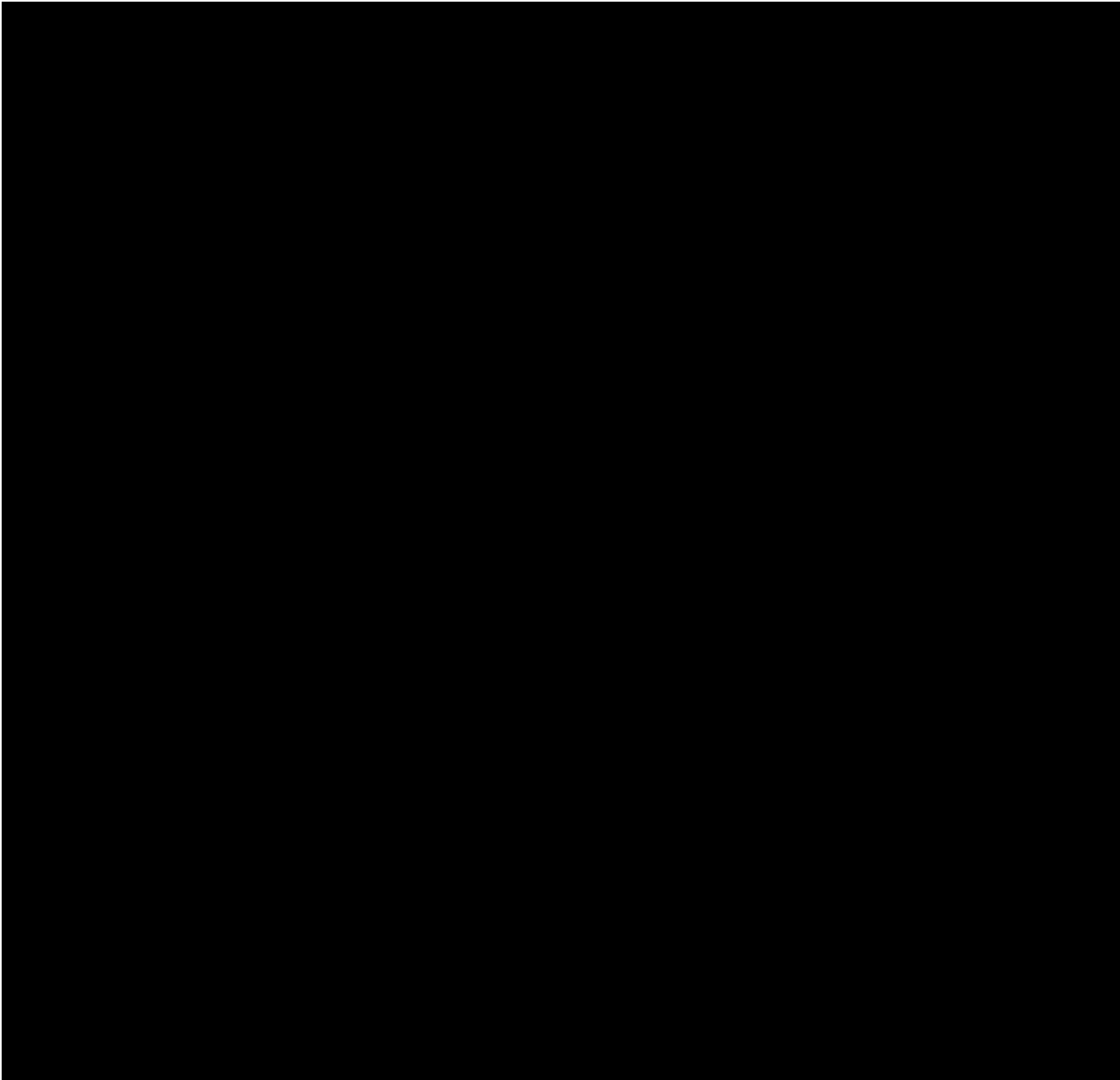
 Potential constraints in onshore construction periods will be agreed with local stakeholders.

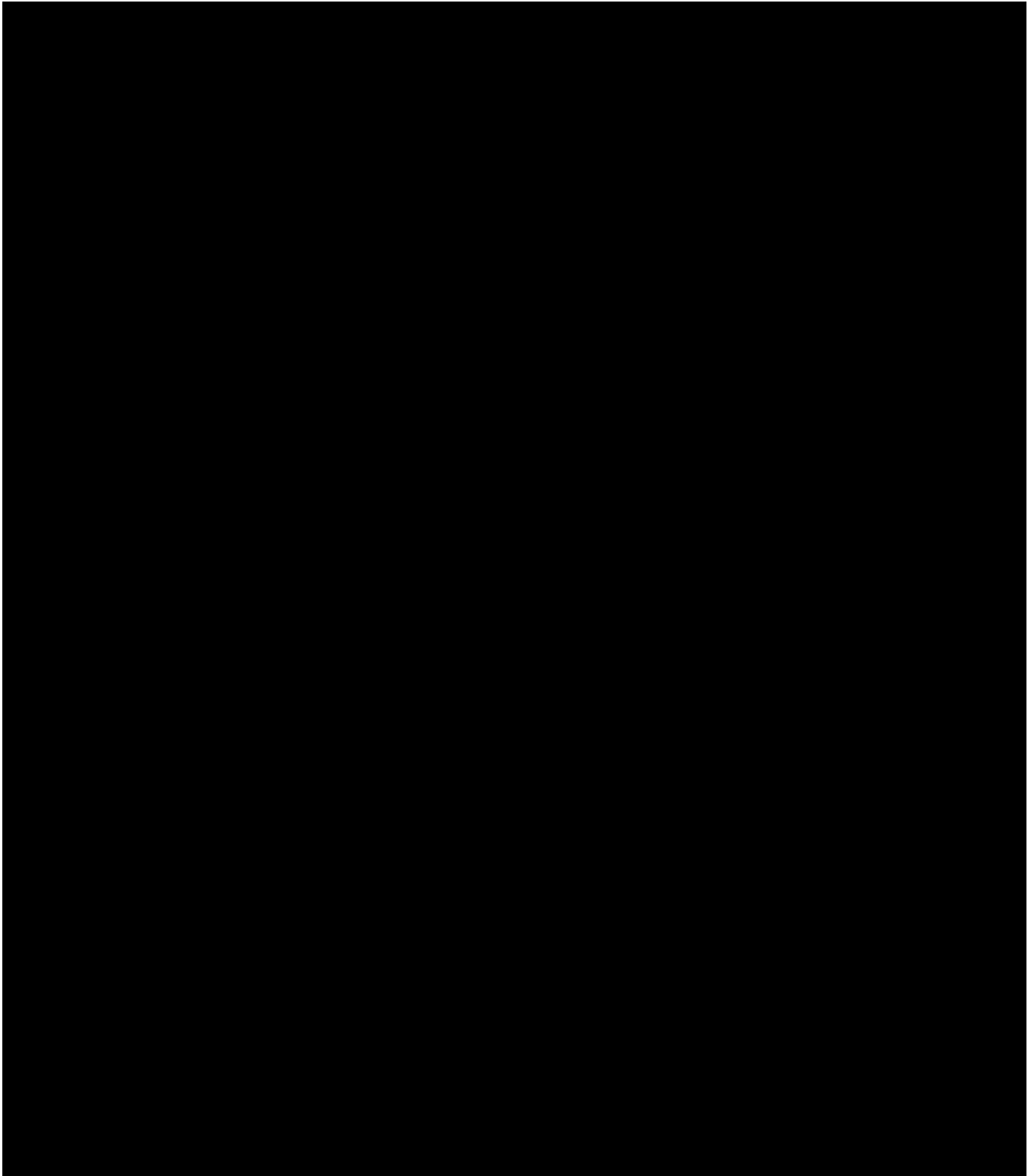
The Project's offshore construction plan and milestones, including the permissible offshore construction window, is illustrated in **Figure 10.2-1** below.

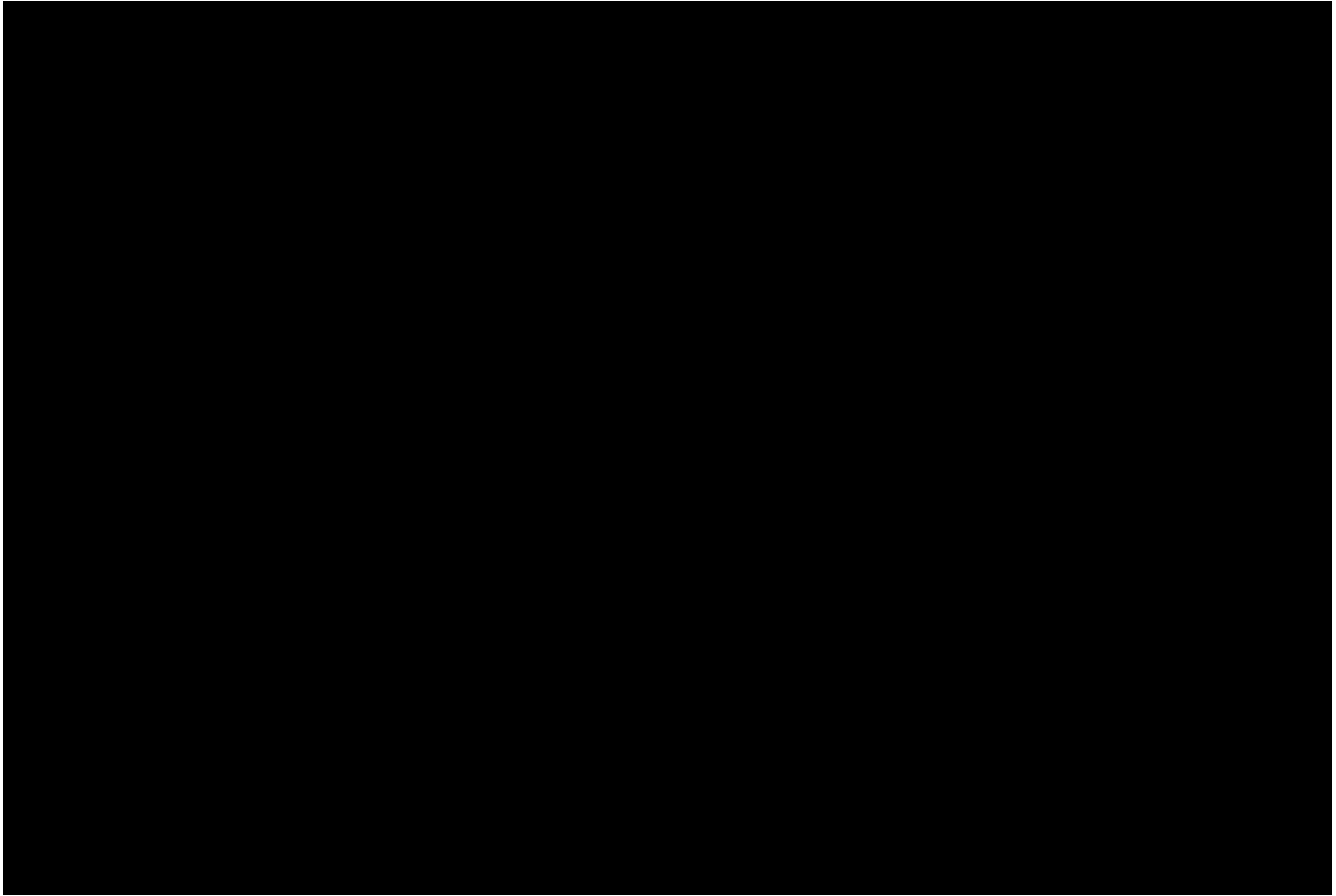


10.3 Detail the status of all critical path items, such as receipt of all necessary siting, environmental, and NYISO approvals.

The status of the key activities and critical path items for the Project are described in **Table 10.3-1**. Progress has been made on many of the activities and critical path items listed below, albeit at different rates, depending on their delivery deadline.









LIBERTY WIND

SECTION 11 - CONSTRUCTION AND LOGISTICS

Proposal for New York State Energy Research and Development Authority in response to Request For Proposals for Purchase of Offshore Wind Renewable Energy Certificates



Photo: Beatrice offshore wind farm

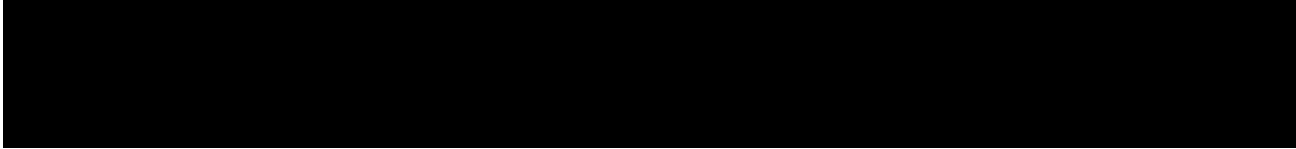
SECTION 11 CONSTRUCTION AND LOGISTICS

OVERVIEW - A ROBUST CONSTRUCTION AND LOGISTICS SET-UP USING A NEW YORK PORT

Vineyard Wind has developed a cost-effective and robust construction and logistics concept for Liberty Wind (the “Project”). This concept draws from the considerable body of expertise and execution experience that Vineyard Wind team members and the parent companies have gained building several of the world’s leading offshore wind projects (see **Section 2**).

The Project’s engineering, construction, and logistics concept also builds on the investments and experiences from Vineyard Wind’s first 800 MW project, which will begin construction in 2019. Since 2016, Vineyard Wind has conducted extensive supply chain investigations with numerous US and international manufacturers and supply chain partners, as described in **Section 9**.

Vineyard Wind has completed a comprehensive logistical analysis for the Project. The analysis assesses multiple installation concepts, including port facilities in New York and different Jones Act compliant vessel spreads, to identify the most robust logistical solution for outfitting, assembly, storage, and deployment of the Project.



This section of the Proposal addresses necessary arrangements and processes for outfitting, assembly, storage, and deployment of major Project components such as turbine nacelles, blades, towers, foundations, and transmission support structures. Please provide a construction and logistics plan that captures the following objectives:

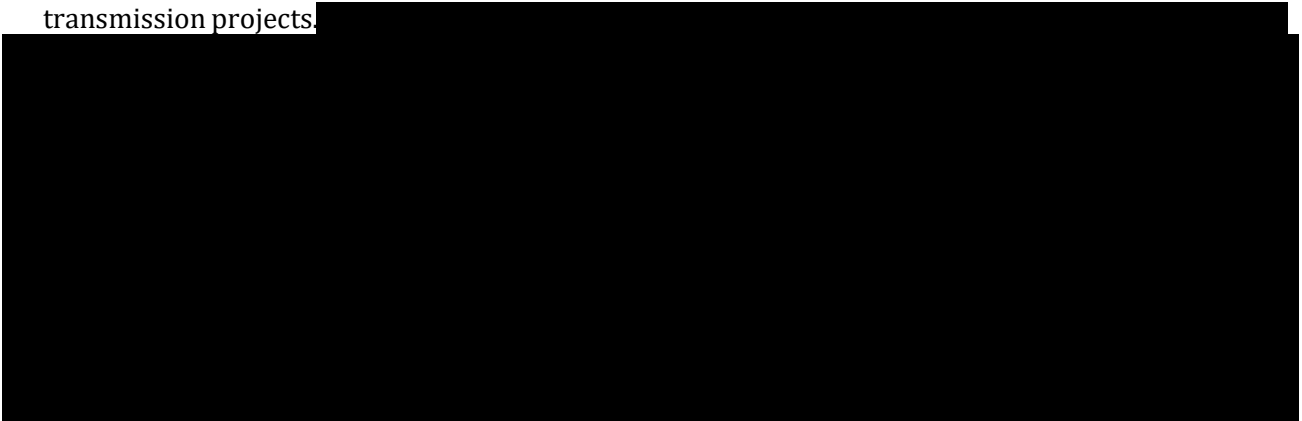
- 1. List the major tasks or steps associated with deployment of the proposed Project and the necessary specialized equipment (e.g., vessels, cranes).*

MAJOR PROJECT DEPLOYMENT STEPS AND NECESSARY EQUIPMENT

Liberty Wind consists of the following six main work packages:

- Foundations
- Wind turbine generators
- Inter-array cables
- Electrical service platform
- Export cables
- Onshore works

The Vineyard Wind team and parent companies are among the most experienced in the world, with development and construction experience from more than 30 European offshore wind farm and transmission projects.

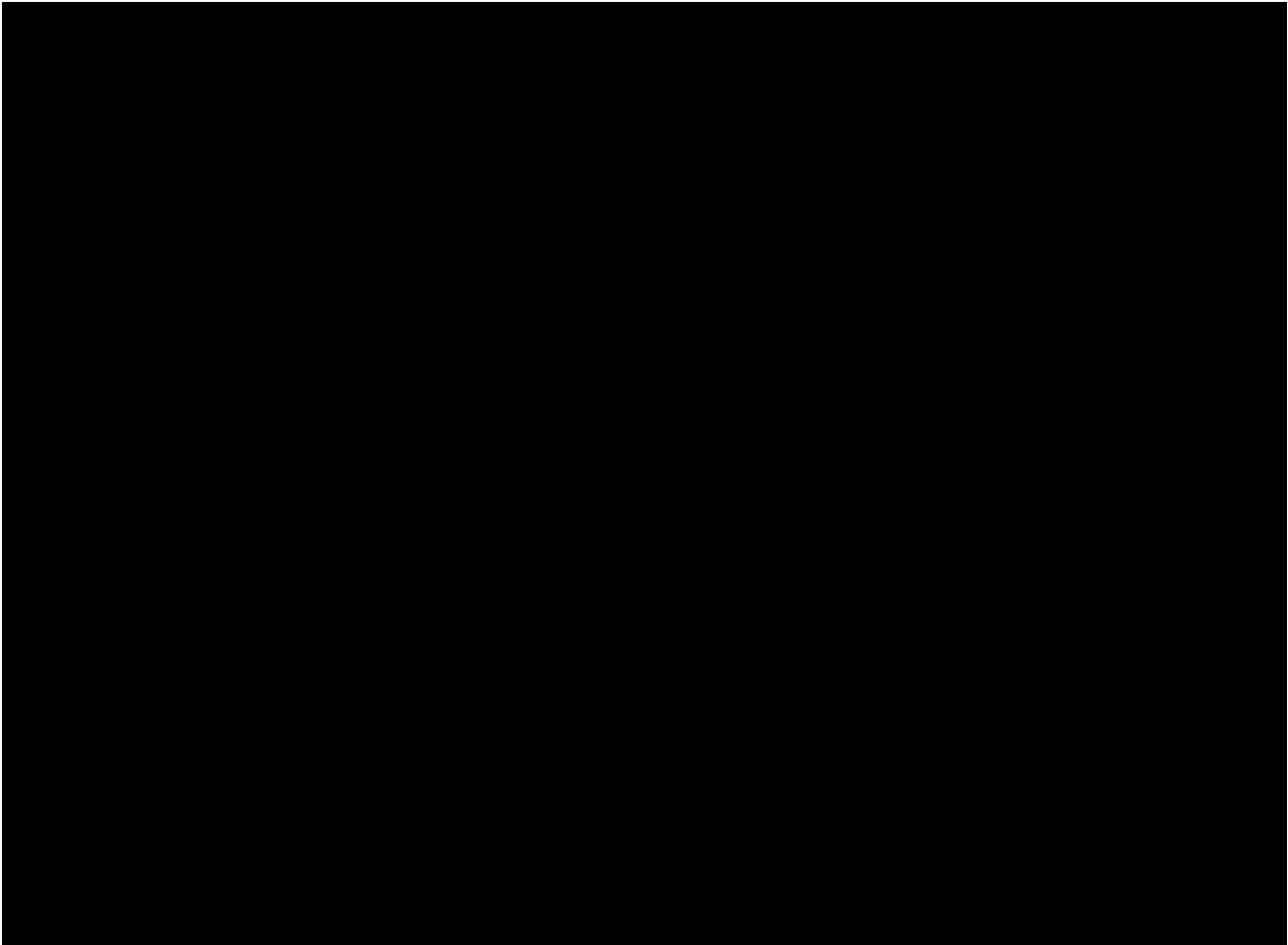


Vineyard Wind has also conducted a detailed logistical analysis for multiple installation scenarios. Among other things, this analysis examines various vessel spreads and potential use of different harbors, including their operational and load-out capabilities.

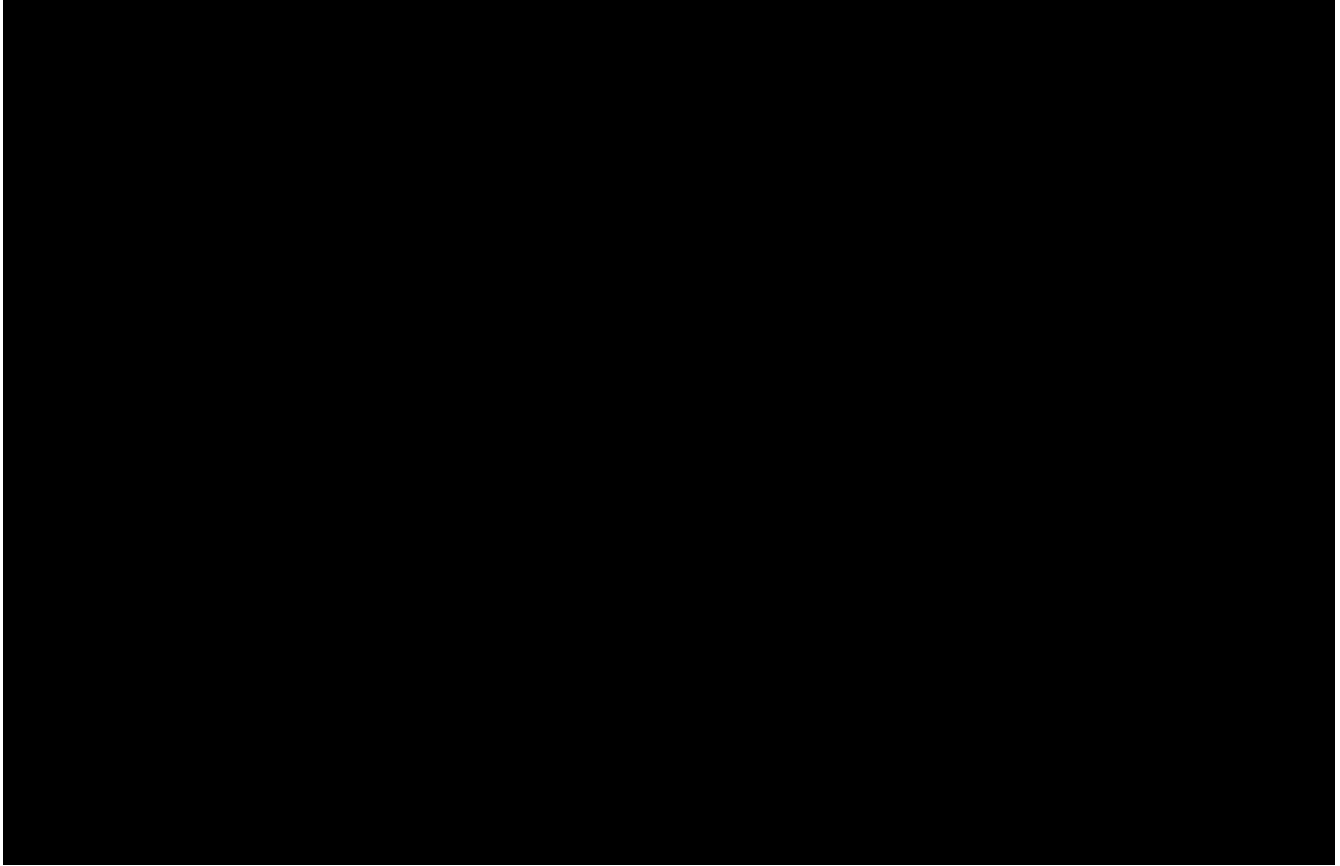


These results provide Vineyard Wind with unique insights and supports the development of an ambitious and robust logistical concept and construction plan. See **Attachment 11.1-1** for the full logistical analysis.

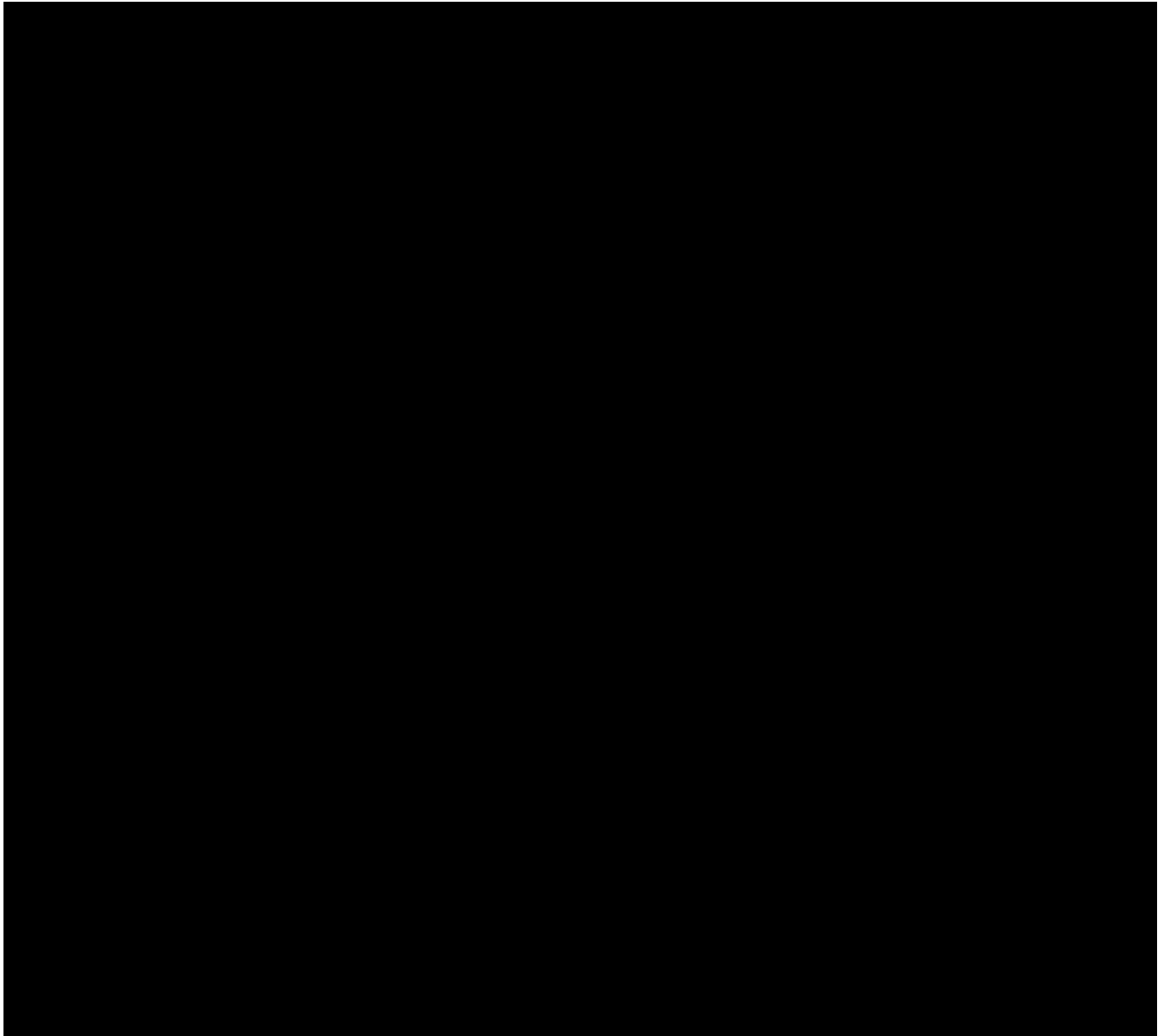
A schematic construction plan that depicts the projected sequence of major tasks for each of the Project's work packages is provided in **Figure 11.1-1**. A detailed Project schedule can be found in **Section 10**.

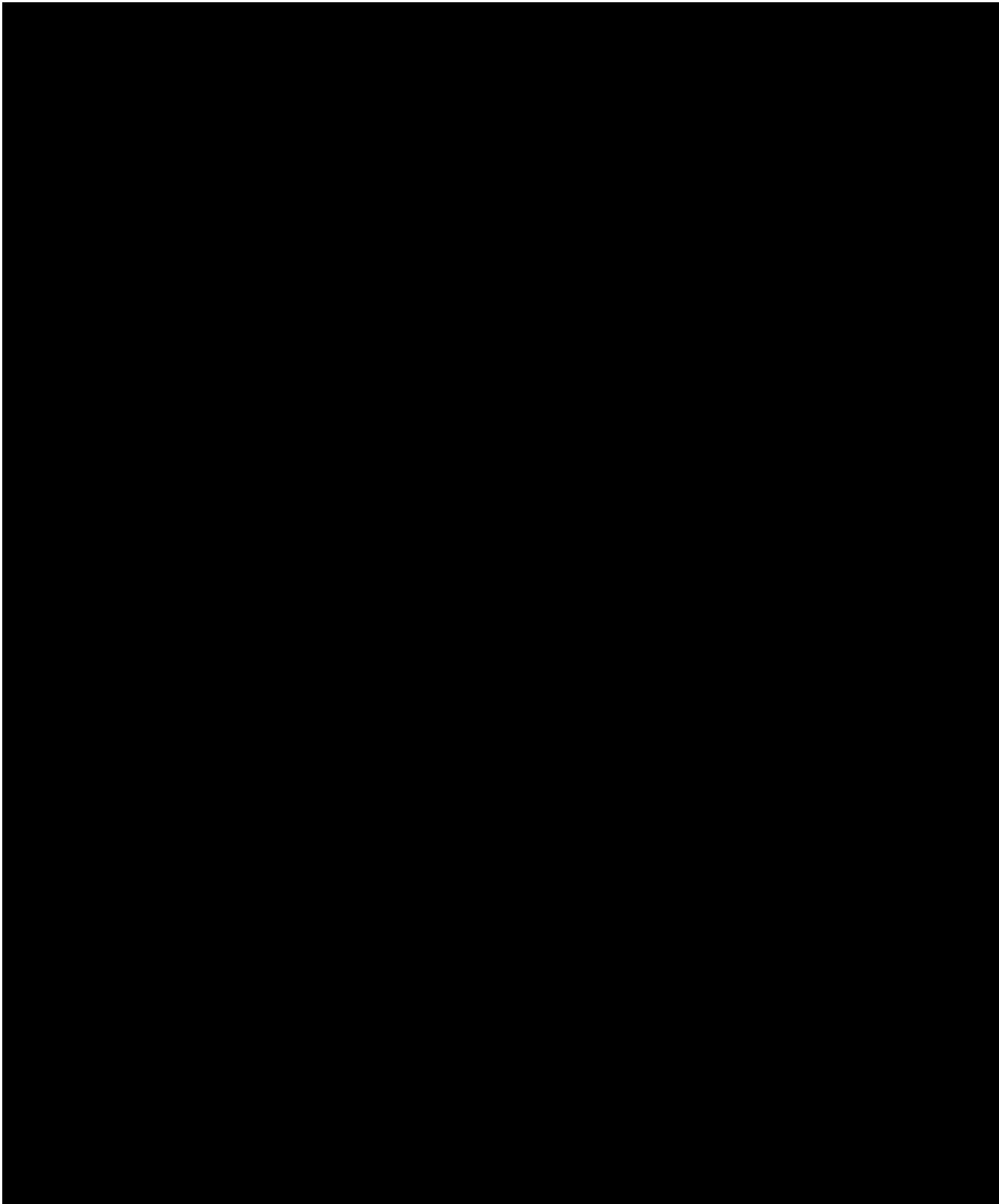


The transport and installation vessel spread terminologies used throughout this section are defined in **Table 11.1-1**.



An overview of the major tasks associated with Project deployment, including the specialized equipment required to complete each of the work packages, is provided in **Table 11.1-2**.





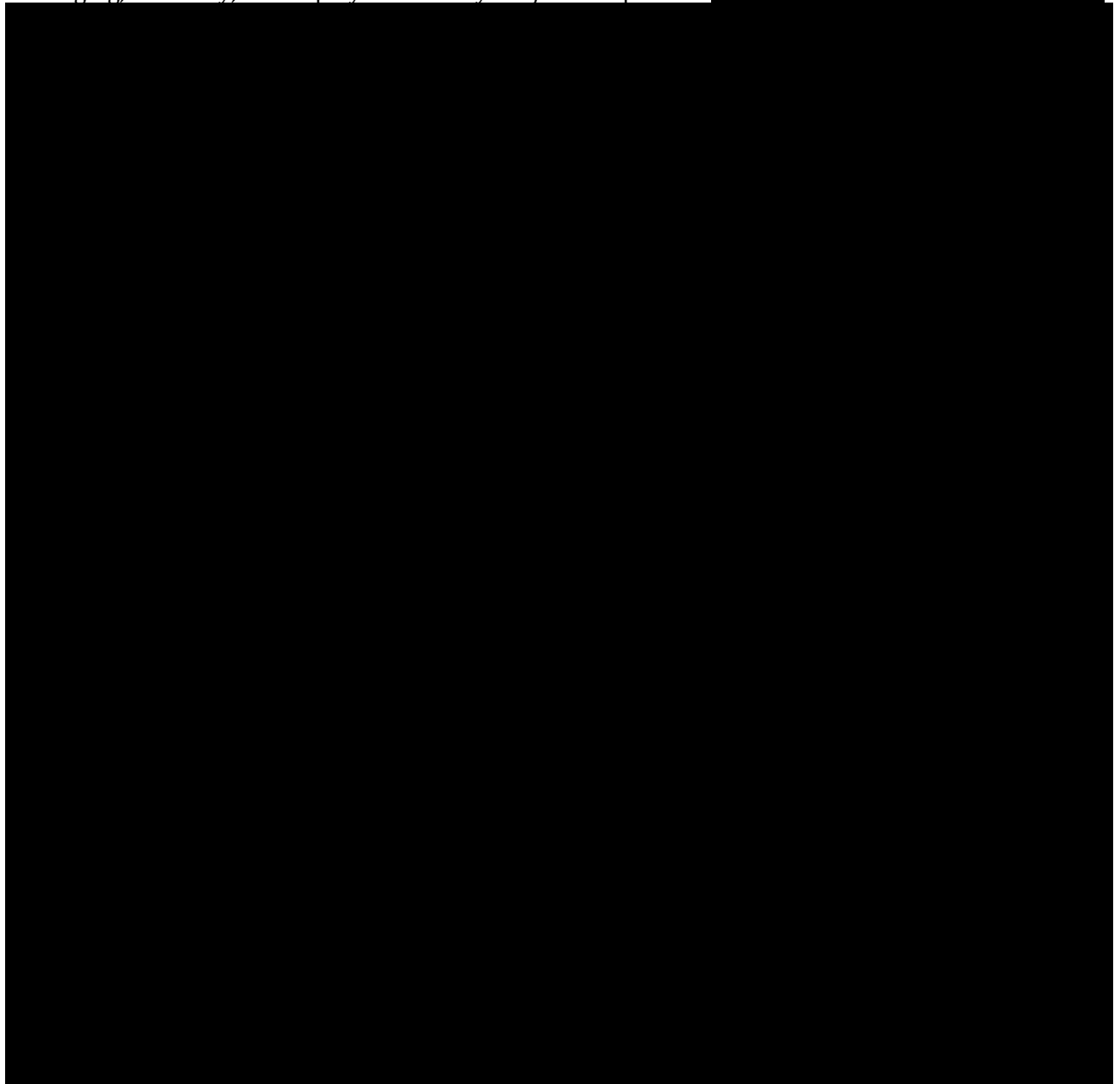
-
2. *Identify the marine terminals and other waterfront facilities that will be used to stage, assemble, and deploy the Project for each stage of construction.*
- a) *If available, evidence that Proposer or the equipment/service provider have right(s) to use a marine terminal and/or waterfront facility for construction of the Project (e.g., by virtue of ownership or land development rights obtained from the owner).*
 - b) *If not available, describe the status of acquisition of real property rights for necessary marine terminal and/or waterfront facilities, any options in place for the exercise of these rights and describe the plan for securing the necessary real property rights, including the proposed timeline. Include these plans and the timeline in the overall Project schedule in Section 6.4.10.*
 - c) *Identify any joint use of existing or proposed real property rights for marine terminal or waterfront facilities.*
-

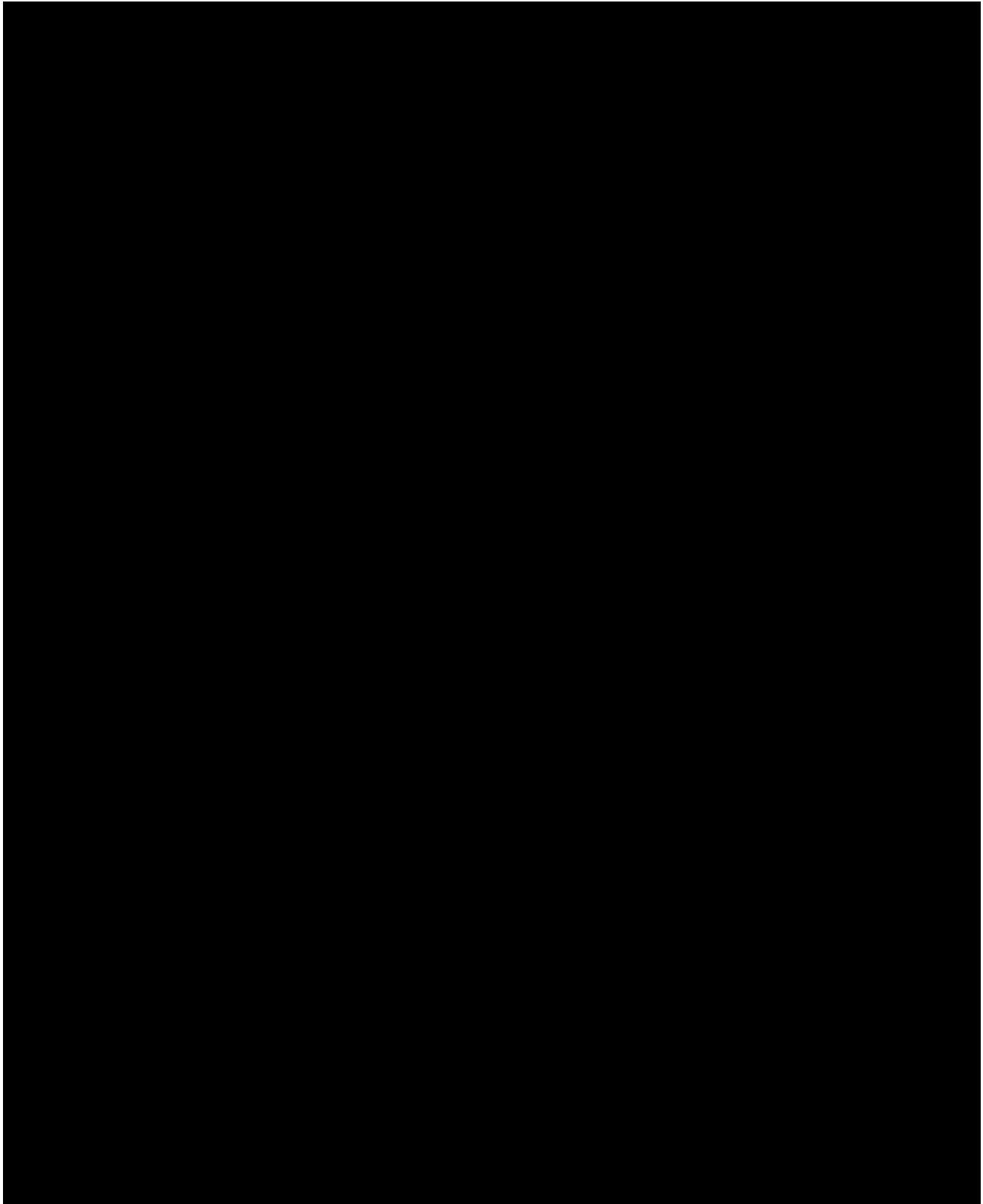
FACILITIES FOR CONSTRUCTION OF THE PROJECT

Constructing an offshore wind farm in a timely and cost-effective manner requires the availability of specialized facilities and vessels to stage, assemble, and deploy various project components. To determine the best available options for the Project, Vineyard Wind conducted a logistical analysis of different installation solutions, including harbor facilities and vessels. This analysis is presented and explained in **Attachment 11.1-1** as well as **Section 10**.

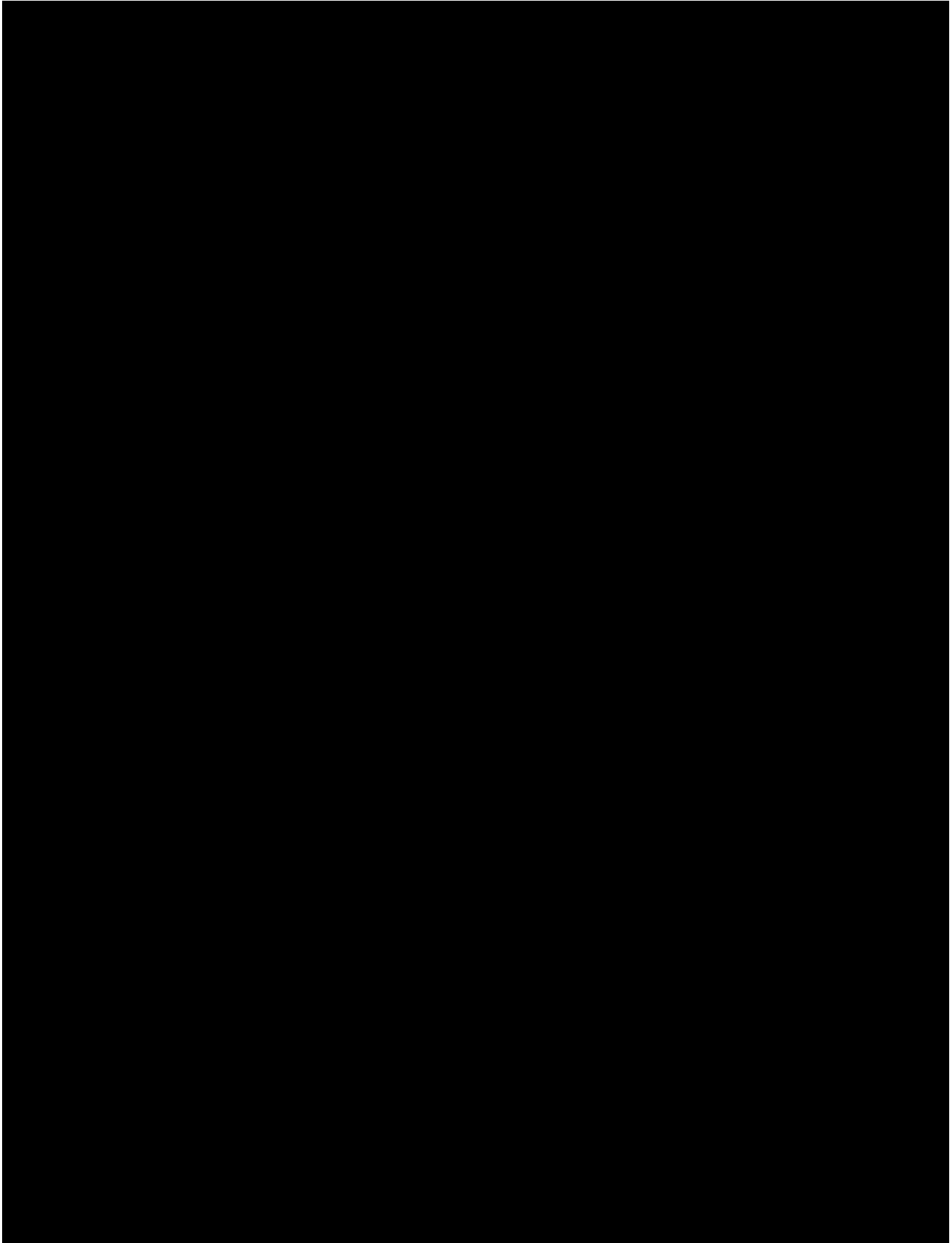


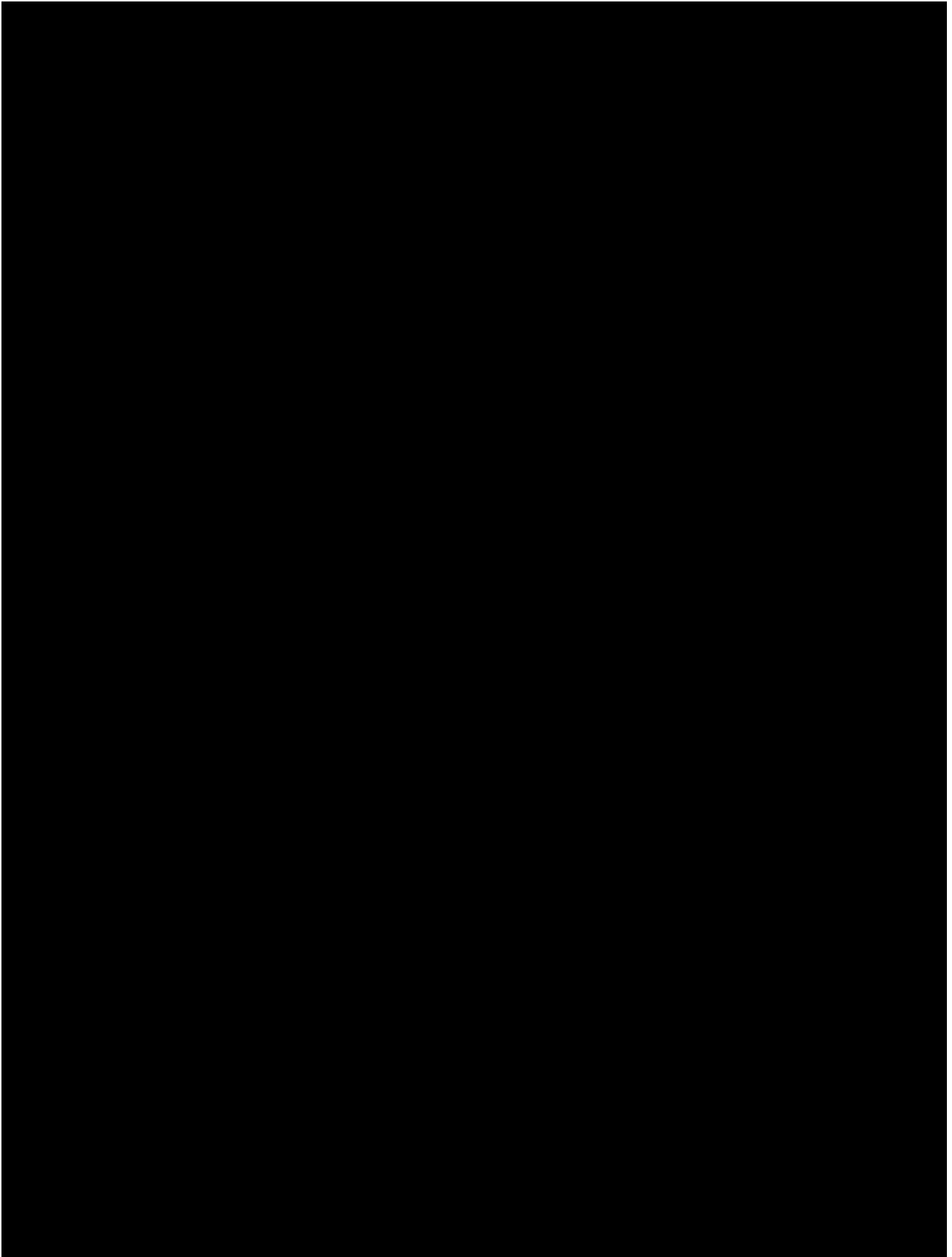
Table 11.2-1 provides a summary of the facilities that Vineyard Wind has already secured for the staging, assembly, and deployment of key Project components.





The location of the Project relative to the New York port selected for staging, assembly, and deployment is illustrated in **Figure 11.2-2**, and existing harbor agreements are described below.





-
3. *Describe the proposed approach for staging and deployment of major Project components to the Project site. Include a description and discussion of the laydown facility/facilities to be used for construction, assembly, staging, storage, and deployment.*
-

APPROACH FOR STAGING AND DEPLOYMENT OF MAJOR PROJECT COMPONENTS

Vineyard Wind, as noted above, has invested considerable resources investigating harbor facilities and logistical solutions for the staging and deployment of the Project's major components. The results of the analyses performed are provided in **Attachment 11.1-1**.

The following sections provide an overview of the approach for staging and deployment of major project components for each of the following work packages:

- Foundations
- Wind turbine generators
- Inter-array cables
- Electrical service platform
- Export cables
- Onshore works

FOUNDATIONS

The chosen foundation concept for the Project consists of a monopile (MP) and TP, and is the same concept being deployed for the first 800 MW project. Vineyard Wind recently completed a comprehensive competitive tendering process for that project's foundations, and has received binding offers for the fabrication, transportation, and offshore installation logistics. At present, it is difficult to find US manufacturers capable of rolling the heavy steel plate to fabricate MP and TP cylinders.

For MPs, this means that, for the moment, the most logistically sound and price competitive solution for MP staging and deployment is to ship them directly from fabrication facilities to the Offshore Wind Generation Facility site for installation. As discussed above, TP cylinders will be outfitted and deployed from Coeymans in New York.

Foundation deployment consists of the following major tasks:

- Scour protection transport and installation;
- MP transportation to and installation on site; and
- TP transportation to staging and assembly harbor, and load-out to the Offshore Wind Generation Facility site for installation

SCOUR PROTECTION INSTALLATION STEPS

The benefit of scour protection is that foundation penetration can be minimized, as the design does not have to account for significant scour development. If scour protection is used, it is expected to be a single layer of stone/rock material placed on the seabed where the foundations are to be installed.

[REDACTED]

The steps shown in **Table 11.3-1** describe the installation of stone/rock material, which is the most widely used scour protection in the offshore wind industry.

[REDACTED]

Several techniques exist for placing scour at the base of WTG foundations, such as side dumping or fall pipes. Fall pipes, in which a pipe extends from a vessel towards the foundation, has the greatest precision, and is sometimes supported by an ROV guided lower end.

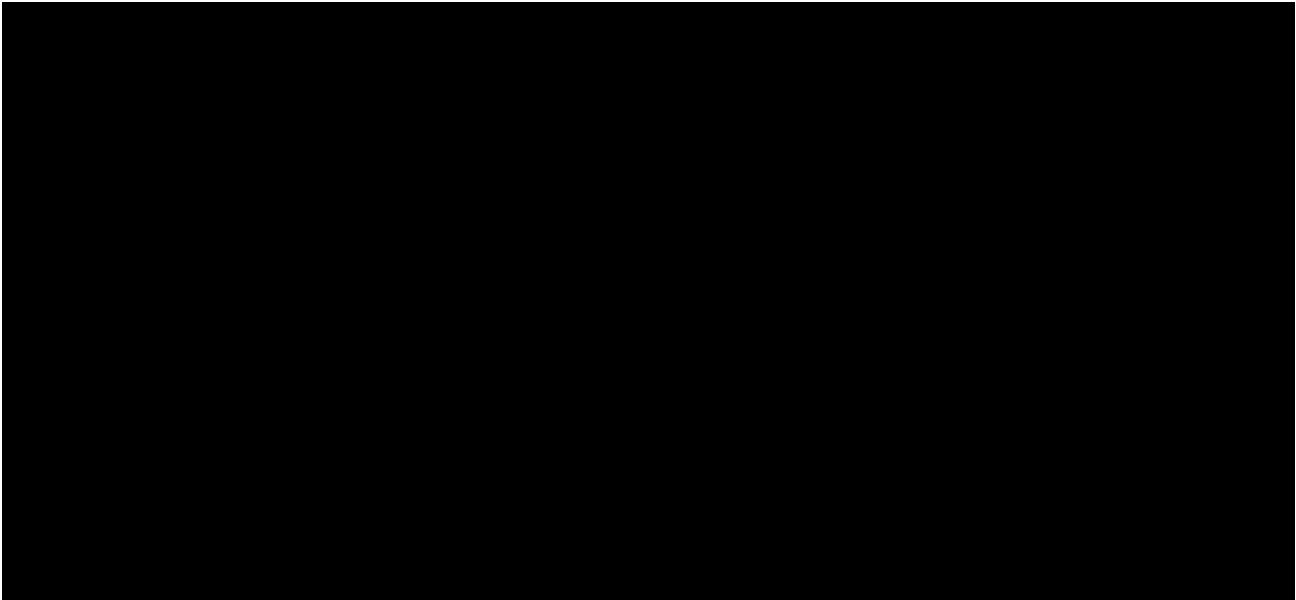
[REDACTED]



FOUNDATION TRANSPORT

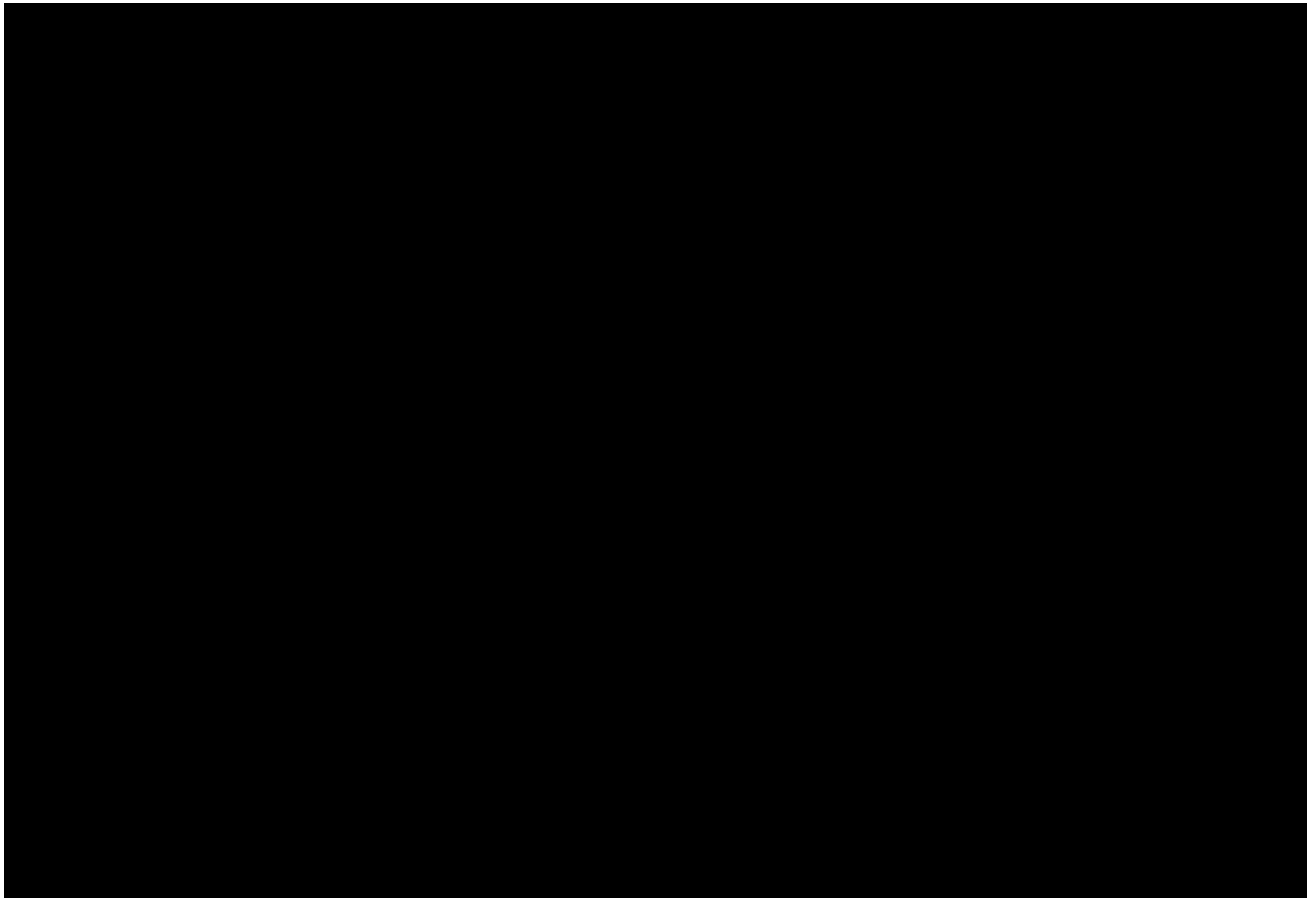
[REDACTED] as shown in **Figure 11.3-2, Figure 11.3-3, Figure 11.3-4, and Figure 11.3-5.**

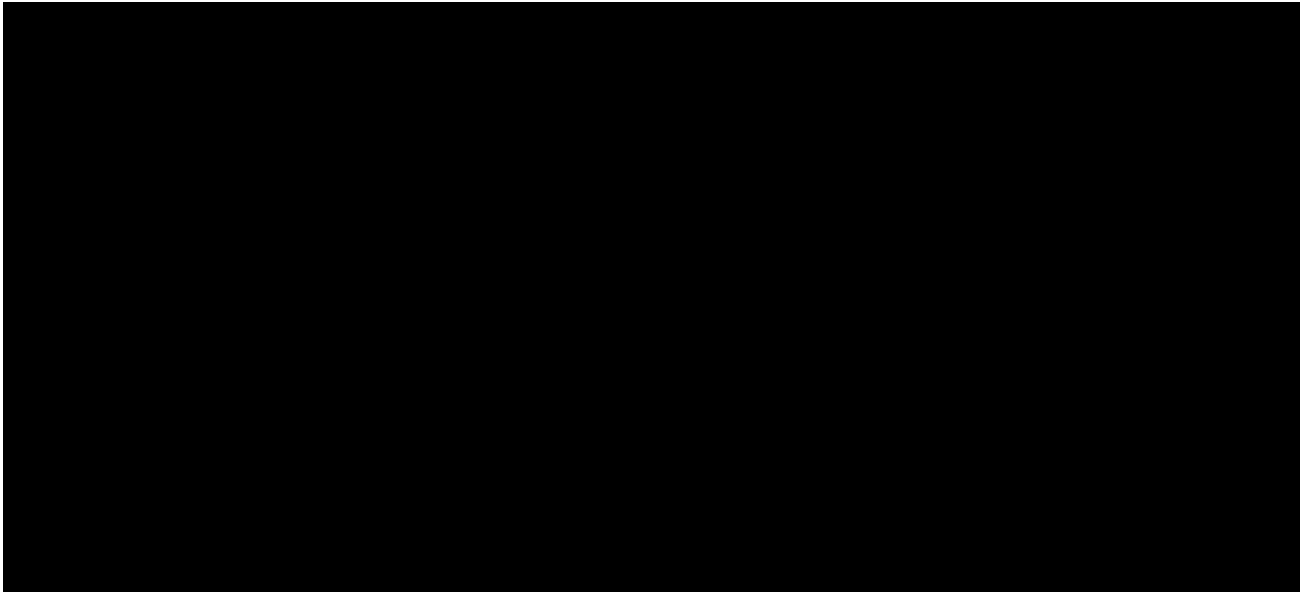
[REDACTED]

as shown on **Figure 11.3-6 and Figure 11.3-7.**



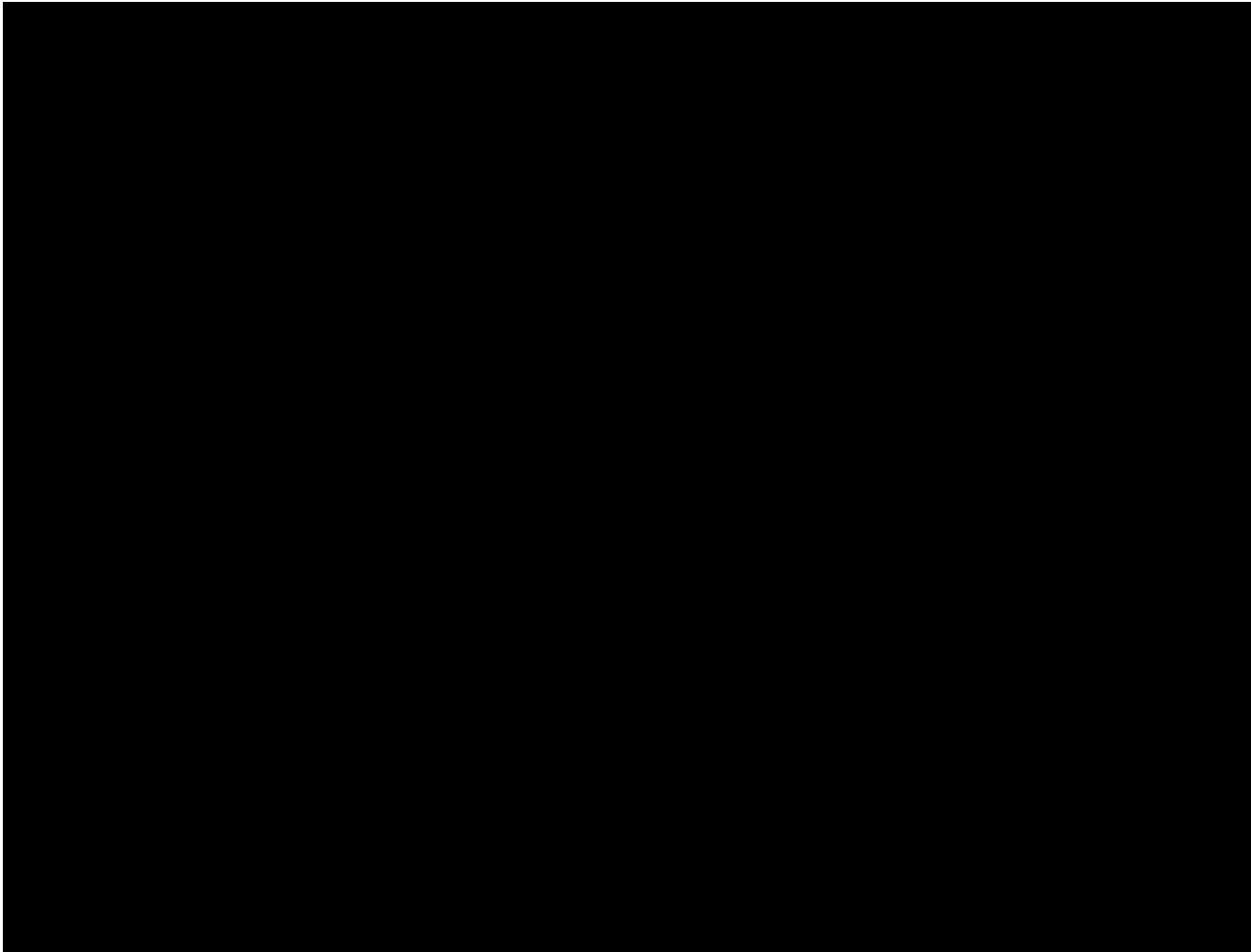
Heavy transport vessels are generally very maneuverable, and some are equipped with DP systems, 
 DP is a computer-controlled system that automatically maintains a vessel's position and heading by using its own propellers and thrusters (i.e., without the use of anchors).





FOUNDATION INSTALLATION

The foundations will be delivered to the Offshore Wind Generation Facility site and installed by a heavy lift installation vessel. **Table 11.3-3** describes the installation of foundations.



The currently preferred heavy lift installation vessel will be a DP floating vessel, as shown in **Figure 11.3-8**.

Figure 11.3-8 Heavy Lift Installation Vessel



Copyright: Heerema Marine Contractors and Seaway Heavy Lifting

At each foundation location, the MP will be picked up (upended) by the main crane and placed in a gripper frame or piling template before being lowered to the seabed. The gripper frame or piling template is used to stabilize the vertical alignment before and during pile driving. Once stabilized, the crane hook is released, and the hammer picked up and placed on top of the MP. Pile driving will commence, starting with soft-start to ensure vertical alignment, and reduce the risk of pile runs. The hammer is then removed, and a survey of the vertical alignment and flange is carried out to ensure quality.

Noise mitigation systems can be applied during pile driving, either near field, through the use of a big bubble curtain, or a combination of the two. If an anode cage is required, it will be installed prior to mounting the transition piece. The electrical connection will be installed by a remotely-operated vehicle (ROV). Once the MP is installed, the TP will be picked up and placed on the monopile, using either a grouted or bolted connection.

Other vessels required during this operation include tugs, guard vessel, and a crew transfer vessels (CTV) or a helicopter.

ELECTRICAL SERVICE PLATFORM

Vineyard Wind has recently completed a comprehensive competitive tendering process for the ESP for the first 800 MW project, and has received binding offers from experienced companies and, where applicable, local contractors, for the fabrication, transportation, and offshore installation logistics. Additionally, Vineyard Wind has also initiated detailed discussions, site audits, and Requests for Information from several international and US companies, [REDACTED]




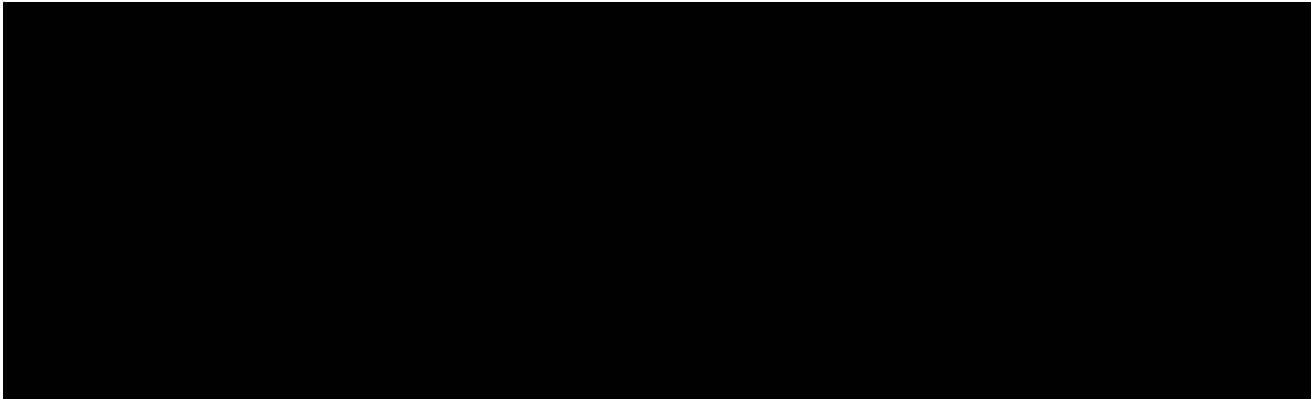
The Project's chosen ESP concept has two primary components: (1) the topside, which houses the electrical components; and (2) the foundation jacket substructure with piles. This is a conventional offshore substation design, the deployment of which will consist of the following main steps:


- ESP transport and installation
- ESP offshore hook-up and commissioning

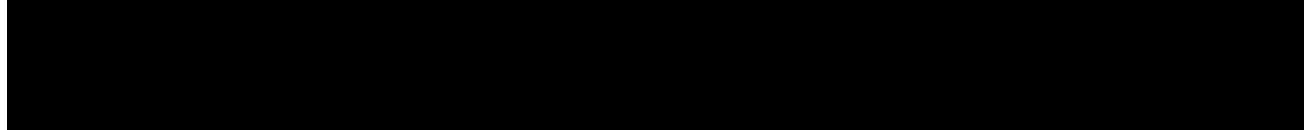
ESP TRANSPORT AND INSTALLATION

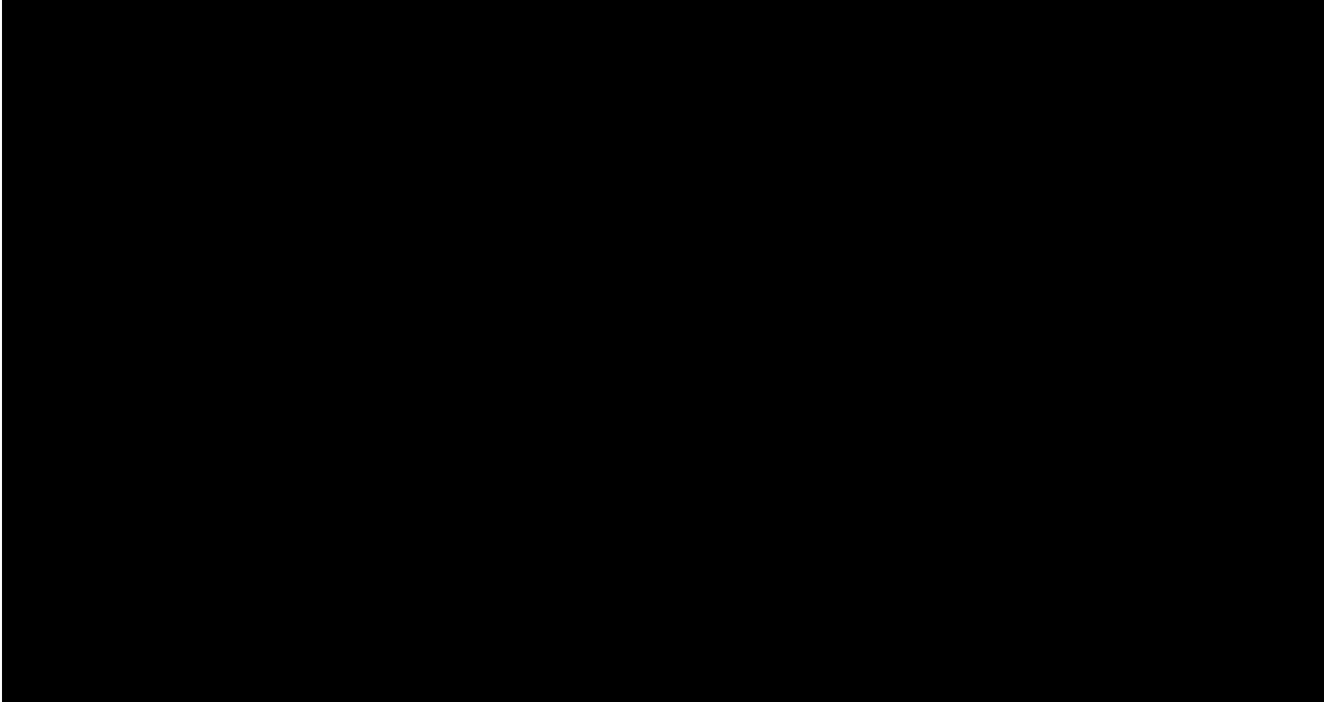
The ESP topsides will be delivered directly to the Offshore Wind Generation Facility site on a transport barge or heavy transport vessel.

The specific steps required to transport the ESP jacket and piles  to the Offshore Wind Generation Facility site are identified in **Table 11.3-4**.

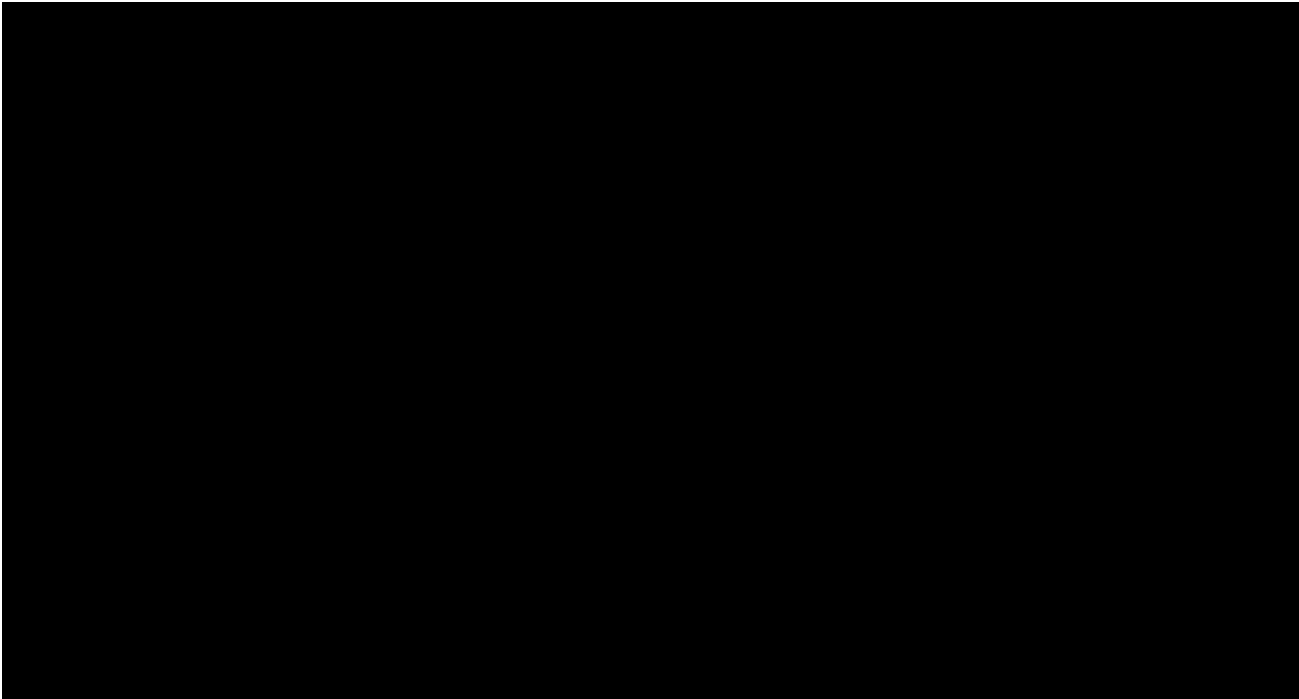


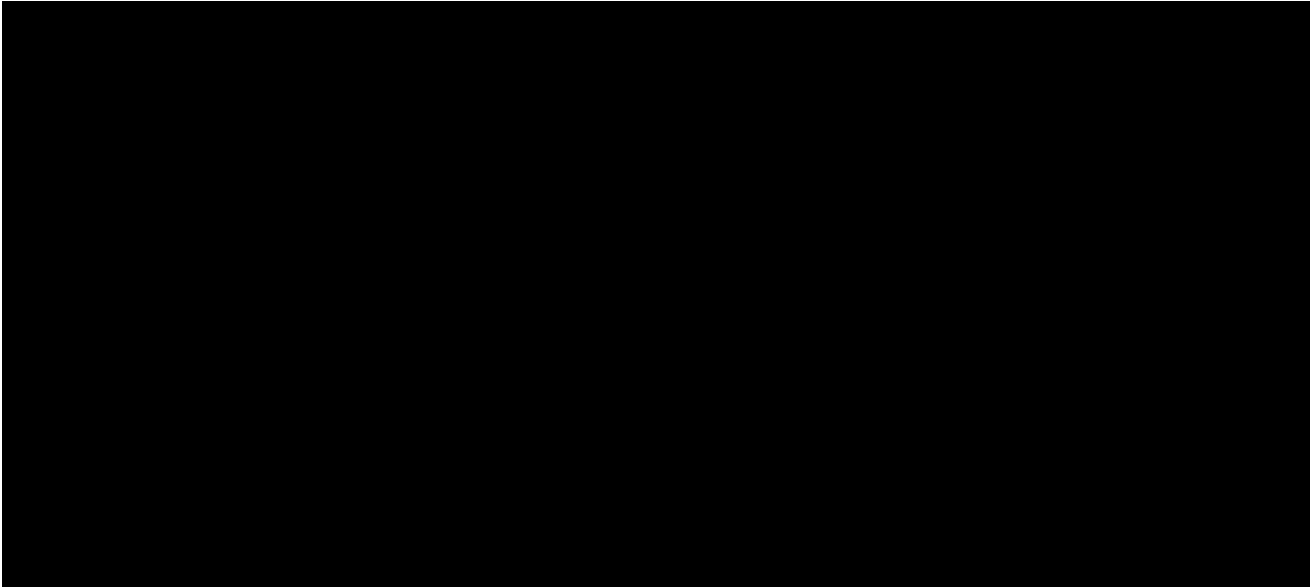
In general, the foundation substructure installation will be similar to the process described under foundation installation above. 





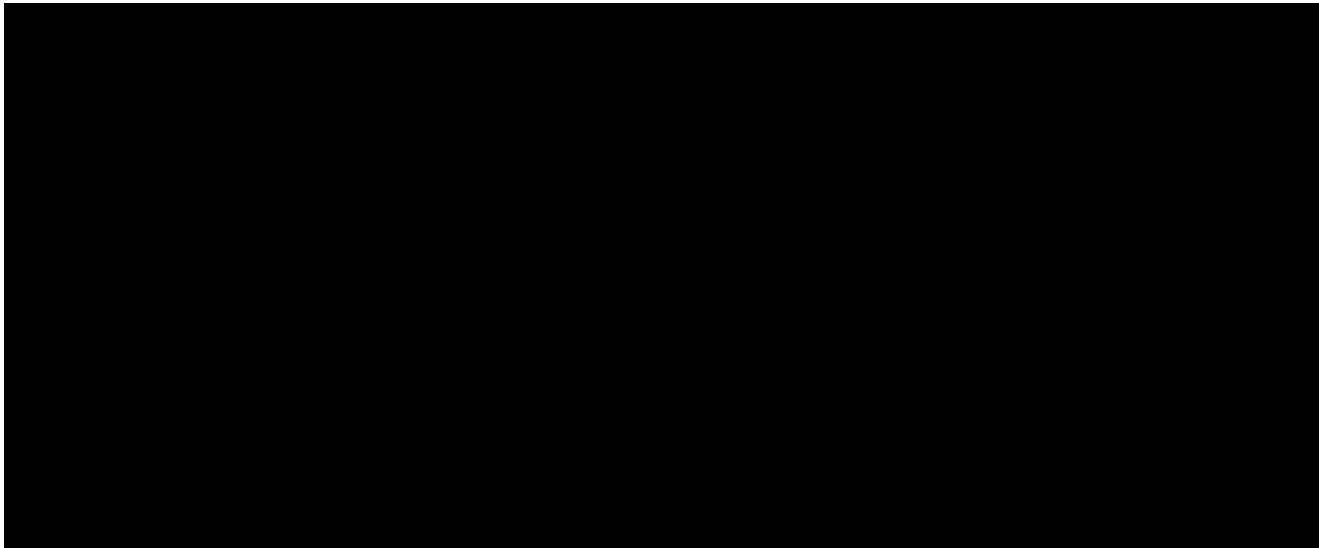
Seabed preparation may be required prior to installation, such as the removal of large obstructions, to prevent excessive seabed gradients. If scour protection is needed, then it will be installed during the same campaign as for the turbine foundations. ESP installation related activities are enumerated in **Table 11.3-5**.






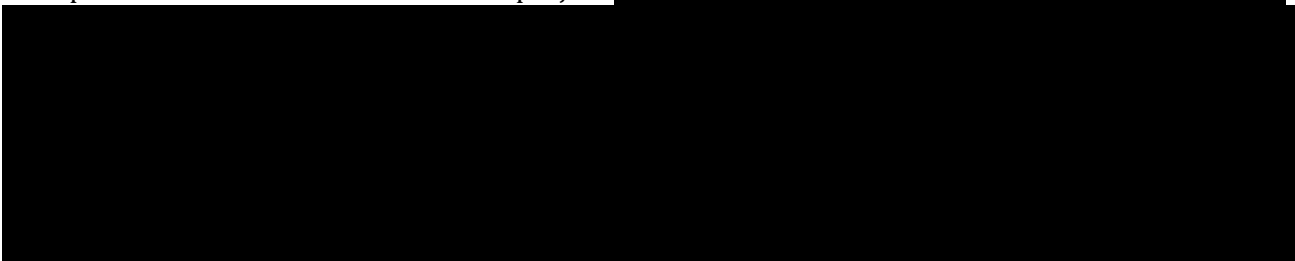
ESP COMMISSIONING

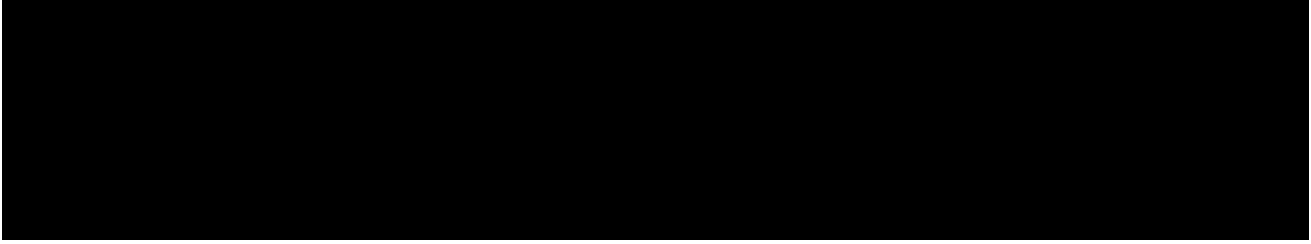
After installation of ESP, the offshore commissioning will commence, which requires the steps indicated in **Table 11.3-6**.



OFFSHORE EXPORT CABLES

Vineyard Wind has been through a comprehensive competitive tendering process for supply of export cables for the first 800 MW project 

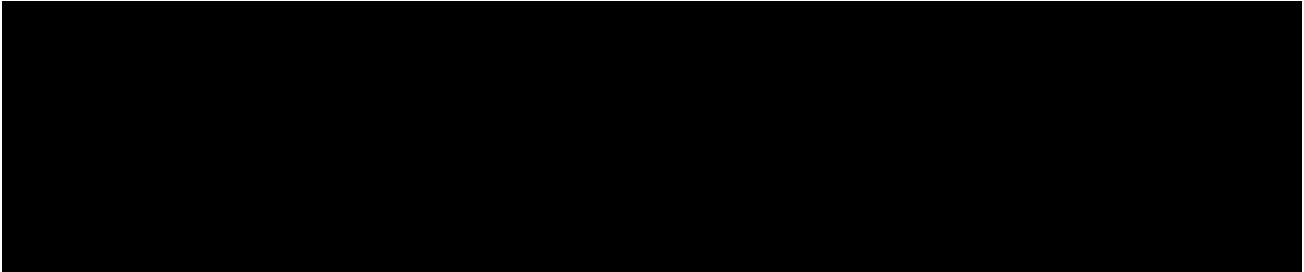




The export cables deployment consists of the following main steps:

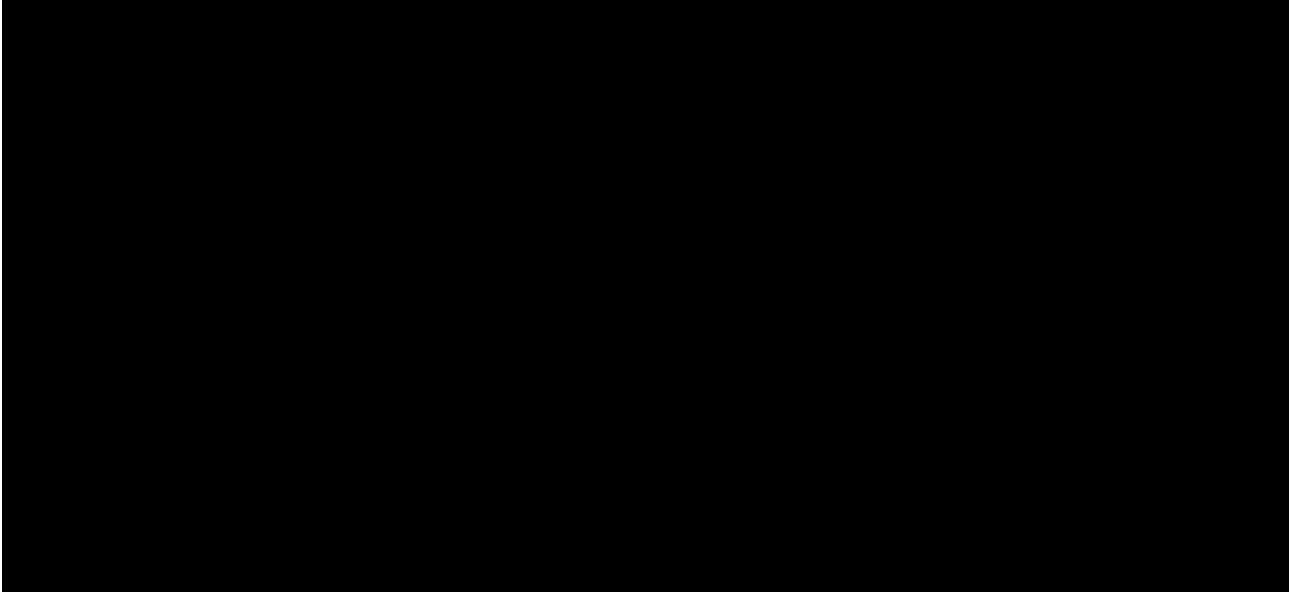
- Transportation, pre-installation surveys and pre-lay grapnel run
- Landfall installation
- Laying and burial
- Pulling into the ESP
- Termination and commissioning works

TRANSPORTATION, PRE-INSTALLATION SURVEYS, AND PRE-LAY GRAPNEL RUN



LANDFALL INSTALLATION

Cable installation starts from the landfall locations and continues to the ESP. 



EXPORT CABLE LAYING AND BURIAL

Once the cable landing is complete, the cable laying vessel will move along the cable route while simultaneously laying and burying the cable.

Figure 11.3-10 Indicative Picture of a Plow Burying a Cable

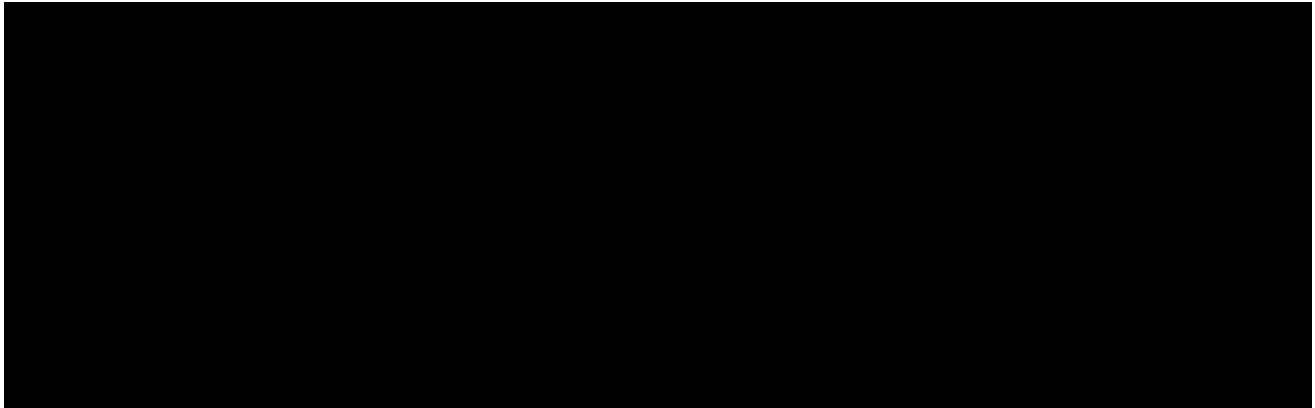


Figure 11.3-11 Vessel Lowering an Offshore Cable Joint Using a Bow



OFFSHORE EXPORT CABLE PULL-IN INTO THE ESP

At the offshore substation platform, a pull-in winch will be located at the first deck level. The J-tubes will have a pre-installed messenger wire and cover plate at the end of the bell mouth. As the cable laying vessel approaches the ESP, it will stop at a calculated distance and the cable will be cut and sealed.

To commence the pulling into the ESP, an ROV will be lowered to the seabed to recover the messenger wire in the J-tube and connect it to the pull-in head of the cable. During pull-in, the cable laying vessel will move back towards the cable route and the cable will be lowered to the seabed as the pull-in progresses until the cable is laid in the seabed.

Once the cable is on the seabed, the pull-in continues from the ESP mounted winch until the cable reaches the hang-off point where a dedicated team will install the temporary hang-off.

OFFSHORE EXPORT CABLE TERMINATION AND COMMISSIONING

After the export cable is secured on the temporary hang-off, the termination team will start with stripping the cables to expose the power cores and the optical fibers. The permanent hang-off will then be installed. The power core will be routed inside the ESP and terminated in the high voltage Gas Insulated switchgear bay. The optical fibers will be connected or terminated into the optical fiber patch box. Ground wires will be connected to the dedicated ground points.

Once termination is completed, the export cables will be fully tested and commissioned to confirm they can be energized safely.

INTER-ARRAY CABLES

Vineyard Wind has issued an invitation to tender to initiate a competitive tendering process for supply of inter-array cables for the first 800 MW project, including fabrication, transportation, and offshore installation logistics. [REDACTED]

The medium voltage inter-array cables will connect the individual WTGs to one another and to the ESP. [REDACTED]

Inter-array cables deployment consists of the following main steps:

- Transportation, pre-installation surveys, and pre-lay grapnel run
- Cable installation (laying and burial)
- Pulling into the foundations and ESPs
- Termination and commissioning works

TRANSPORTATION, PRE-INSTALLATION SURVEYS, AND PRE-LAY GRAPNEL RUN

[REDACTED] A pre-installation survey will be carried out to assess the water depth, identify the shallow geology, and locate objects that might impede the cable installation works. [REDACTED]

CABLE INSTALLATION (LAYING AND BURIAL)

With the required cable length pulled-in, the installation vessel will move off in the direction of the next foundation, surface laying the cable along the planned route. [REDACTED]

Cable burial operations will be performed by a cable laying vessel or a dedicated separate vessel using a burial tool.

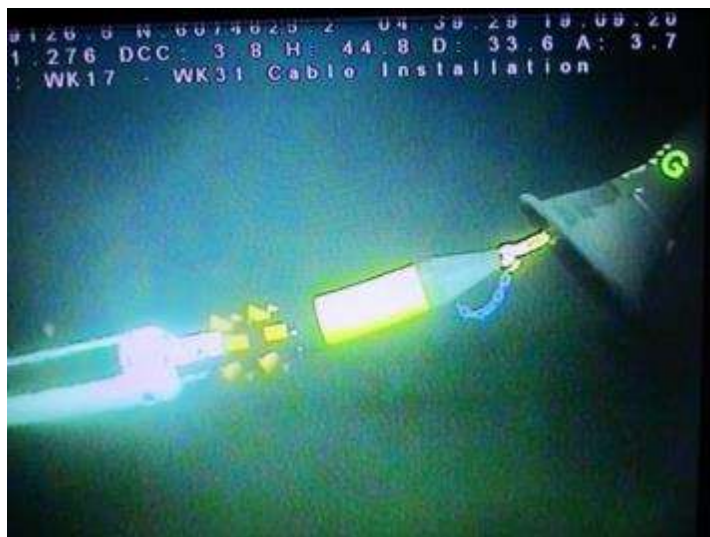
Figure 11.3-12 Inter-array Cable Installation Vessel



PULLING CABLE INTO FOUNDATIONS AND ESP

Messenger wires can be pre-installed onshore or installed offshore depending on the final strategy or specific foundations selected.

Figure 11.3-13 Inter-array Cable Being Pulled into a Foundation



A pull-in rope will be recovered by the installation vessel using a ROV. Once the pull-in rope is on the vessel, it will be connected to the cable pull-in head. After connection of the pull-in rope to the cable rigging, the preparation team will increase tension on the pull-in rope using the tower winch and the installation vessel will simultaneously pay out cable. The pull will continue until the cable is in the right position in the foundation where it will be secured at the cable hang-off point.

INTER-ARRAY CABLE TERMINATION AND COMMISSIONING

WIND TURBINE GENERATORS

Vineyard Wind has been through a comprehensive competitive tendering process for WTG fabrication, transportation, and offshore installation logistics for the first 800 MW project. In November 2018, the company announced the selection of MHI Vestas Offshore Wind as the preferred supplier for that project.

Various installation solutions for WTGs are available in the US and have been tested in the market with suppliers.

The WTG staging and deployment consists of the following major tasks:

- WTG transport to pre-assembly harbor
- Harbor operation and pre-assembly
- WTG installation
- WTG commissioning

The WTG consists of a number of components, each prepared at the fabrication facility or a pre-assembly harbor, ready for final assembly offshore. Each WTG consists of the following components:

- Two to three tower sections
- One nacelle
- Three blades

WTG TRANSPORT

Prior to the commencement of the WTG installation period, components will be transported to the harbor to create a necessary stock of components to keep the installation activities running. WTG components will be transported on heavy transport vessels with crane capacities capable of loading and unloading the components. These vessels, depicted in **Figure 11.3-14**, are readily available in the market. The transport and stowage plans will be designed to obtain the best possible utilization of the vessels. This means a vessel may carry a mix of components not necessarily adding up to complete WTGs or vessels may be dedicated to one component type (i.e., blades or towers).

Figure 11.3-14 Heavy Transport Vessels carrying WTG components



The WTG transport follows the steps shown in **Table 11.3-7**.

HARBOR OPERATION AND PRE-ASSEMBLY

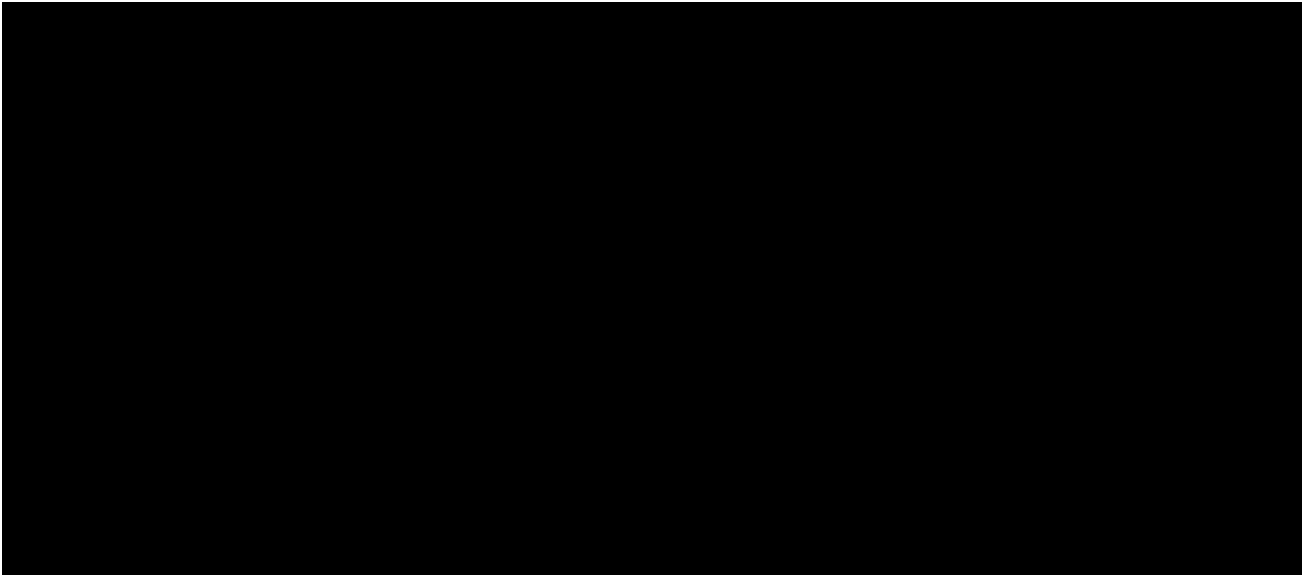
As specified in response to **Question 2**, Vineyard Wind has identified potential harbors for construction activities in reasonable proximity to the Offshore Wind Generation Facility site.

The main activities in the pre-assembly harbor will be moving the WTG components from the heavy transport vessels to storage and back to the quayside for pre-assembly and load-out on to the feeder vessels for transport to the offshore installation site. Pre-assembly works on the WTG components is primarily related to tower sections, which will be up-ended and stacked on tower stands at the

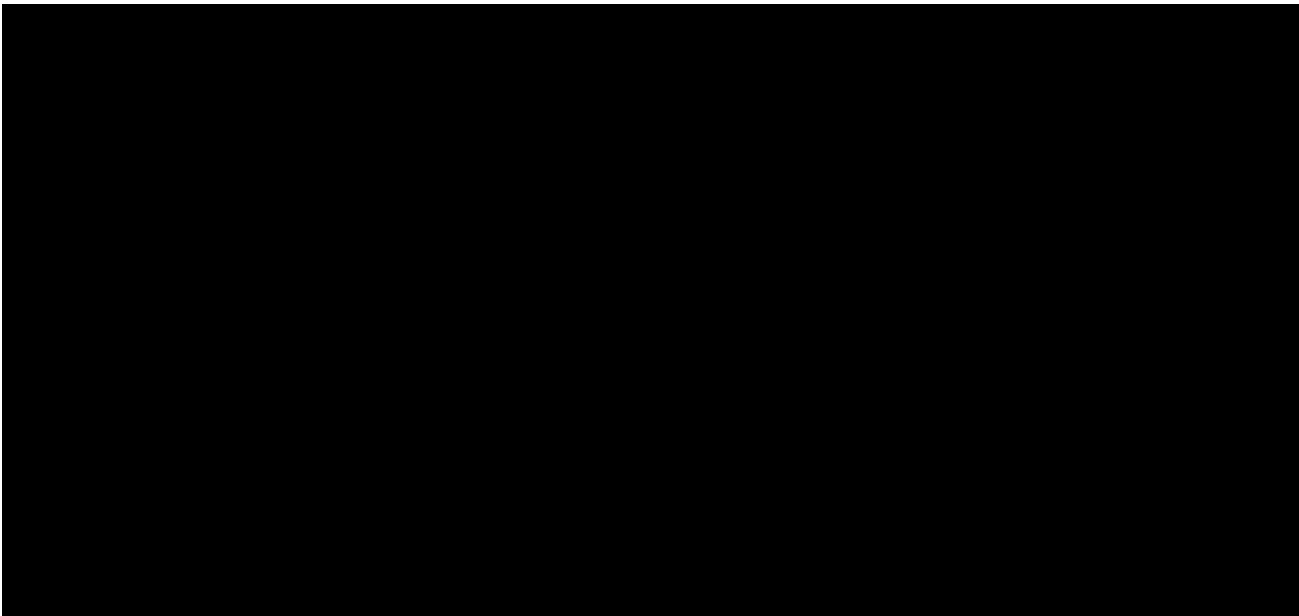
quayside with pre-assembly of electrical and mechanical internal components. Final preparation and turbine specific tests will also be performed on the nacelle to ensure fastest possible offshore commissioning.

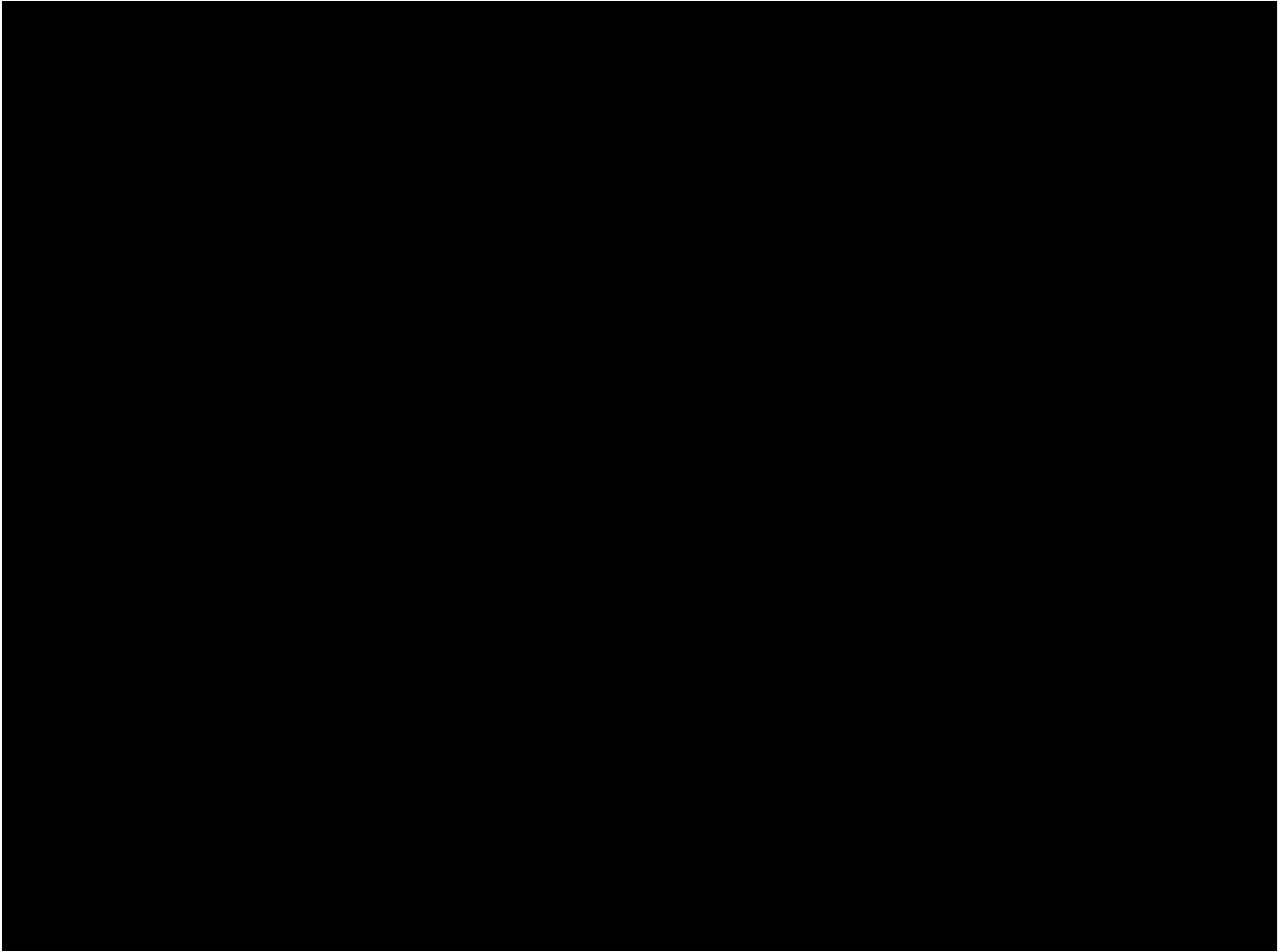
Mobile harbor cranes will be used for inbound logistics where no crane capability is available on the heavy transport vessels and for outbound logistics to lift the WTG components onto the feeder vessels.

When the nacelles, blades and tower sections arrive at port the handling steps depicted in **Table 11.3-8** will occur.



WTG INSTALLATION







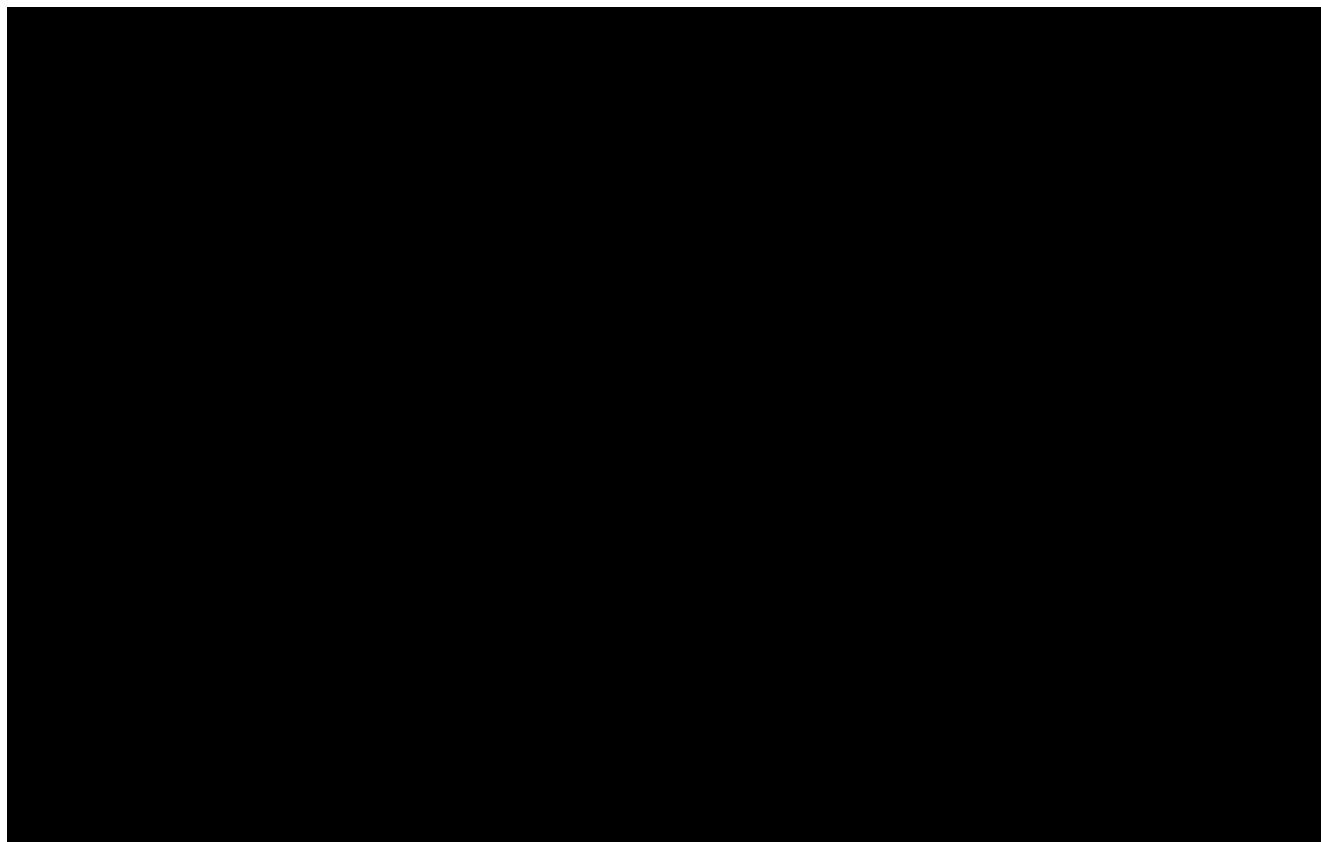
The turbine installation vessel is expected to be a jack-up crane installation vessel, as shown in **Figure 11.3-17.** 


Figure 11.3-17 *Turbine Installation Vessel*



Copyright: Fred. Olsen Windcarrier

The steps shown in **Table 11.3-9** describe the expected WTG installation process.



WTG installation is depicted in **Figure 11.3-18**.

Figure 11.3-18 *Installation of Tower Sections, Nacelle, and Blade*



Copyright: MHI Vestas

The commencement of turbine installation represents the most intense period of vessel traffic in the Offshore Wind Generation Facility site with the foundations, inter-array cables, and WTGs all being installed in parallel.

WTG COMMISSIONING

WTG installation will be followed by the commissioning period where the WTGs will be prepared for operation and energized. Necessary tests will be carried out and documented according to the type certificate of the turbine. WTG commissioning involves conducting the necessary tests of the electrical infrastructure and WTG ahead of passing the unit to the operation and maintenance teams for the duration of its service life. The WTG commissioning and testing phase will be conducted in parallel with the WTG installation phase.

ONSHORE WORKS

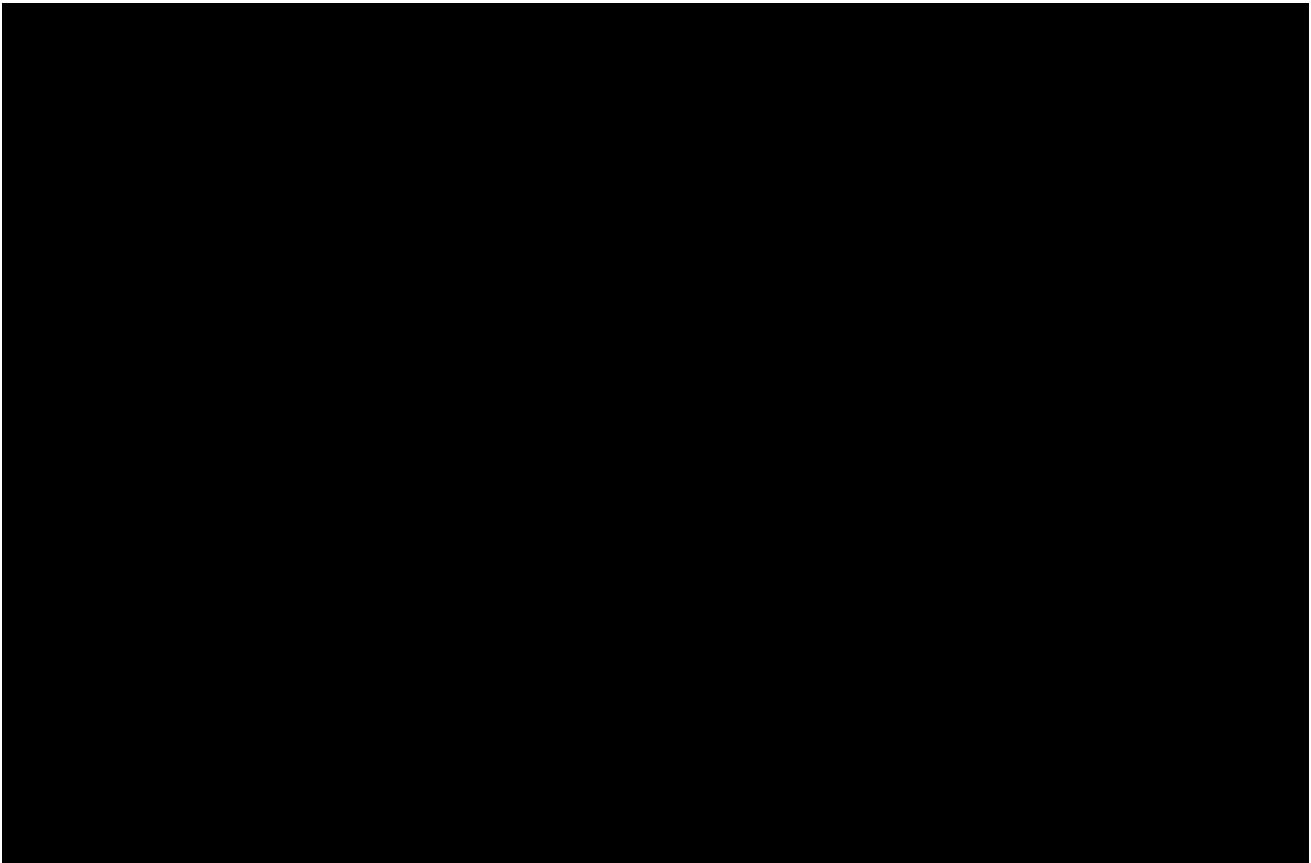
Onshore works for staging and deployment consists of the following major tasks:

- Onshore HVDC converter substation
- Landfall and civil duct bank works
- Cable supply and installation works

ONSHORE HVDC CONVERTER SUBSTATION

The Project will construct an onshore converter





[REDACTED] final design cannot be completed until the New York Independent System Operator interconnection studies are finalized, confirming the final equipment sizing and overall configuration. [REDACTED]



[REDACTED] A security fence and gates will be installed to enclose the onshore substation.

Construction of the onshore substation will be completed in four primary phases: site preparation, assembly of foundations and primary structures, equipment installation, and site restoration. Site preparation involves placement of erosion controls and excavation work. The assembly phase involves constructing the foundations and structural facilities. Phase three involves the installation and erection of electric equipment. Site restoration includes cleanup, landscaping, and site stabilization.

LANDFALL ACTIVITIES



HORIZONTAL DIRECTIONAL DRILLING

HDD will be utilized where



CIVIL DUCT BANKS WORKS

The onshore export cable construction and installation methods include: Conventional cut-and-cover of concrete encased conduit (duct bank), HDD, and conventional cut-and cover of the HVDC onshore export cable (direct buried).

The choice of method will depend on location, mechanical loading considerations, safety factors, environmental impacts, and other applicable requirements. For example, HDD will be used where practicable to avoid direct impacts and potential disruption in wetland areas, recreation areas, and roadway/railway crossings.

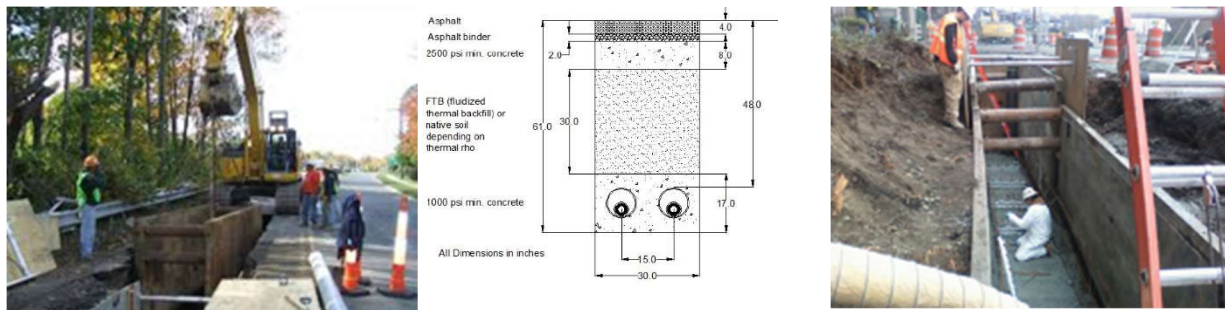


Excavation will be performed with standard earthmoving machinery, including excavators and backhoes, and will be performed in accordance with applicable standards, such as New York State Department of Transportation (NYSDOT) highway work permit conditions. Any excess soil or soil unsuitable for use as backfill will be removed off-site in accordance with applicable regulations.

Duct bank will be used to limit the length and time that trenches will be open for public safety reasons. This is especially important along public roadways, walkways, bike paths, etc. Duct banks will be utilized when the cable is installed under roads, in parking lots, or in the roadway shoulders per the requirements of the NYSDOT. The use of duct banks provides mechanical protection for the cable from vehicle loading. Furthermore, the use of duct banks allows for easier access and less environmental disturbance in the event that a cable repair is necessary post installation.

See **Figure 11.3-20** for typical open trench and duct bank construction methods and cross section. The onshore export cable route is described in greater detail in **Section 3**.

Figure 11.3-20 Onshore Open Trench and Duct Bank



In roadway sections, saw cutting and removal of the existing pavement is required before excavation. After removal of the existing material, the 10-inch (in) and 2-in polyvinylchloride conduits for the onshore export cable and fiber optic cables will be installed in the trench. The duct bank will then be encased in 1,000 pounds per square inch concrete. Native materials will be removed off site and a fluidized thermal material will be used to backfill the remainder of the trench based on NYSDOT specifications and requirements. In areas outside the roadway, native fill may be used to backfill over the concrete encased conduit in place of the fluidized thermal backfill material and the top 8-in section of concrete.

In select areas along the onshore export cable route, where open trenches and splice pits can be safely managed and future mechanical loading is not of concern, the onshore export cable may be direct buried. The trench excavation shall be approximately 8 ft wide at grade, with a 1:1 slope (the slope and width of excavation may vary due to geotechnical conditions and the terrain along the route). Speed shoring may be used in areas with unstable soil conditions. The onshore export cable shall be installed with 4 ft of cover. The onshore export cable will be surrounded by a layer of compacted sand backfill; above the sand a 12-millimeter board (HDPE stokbord) will be installed for mechanical protection along with warning tape. The excavated native material from the trench will be reinstalled on top of the sand layer and compacted in 8 to 12 in lifts to meet compaction requirements.

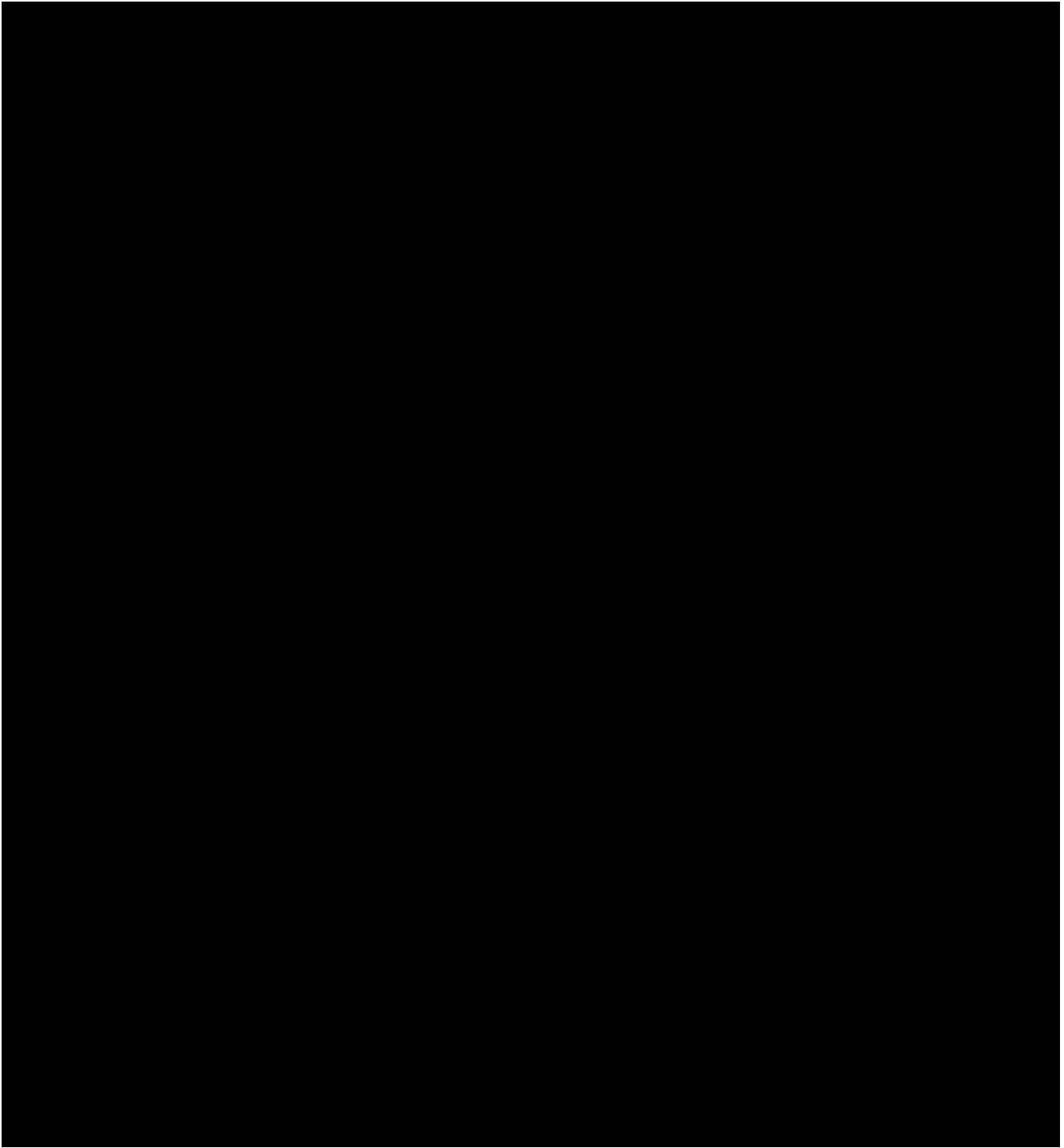
Figure 11.3-21 Neptune Project Installation Along Wantagh Parkway, Long Island**CABLE INSTALLATION**

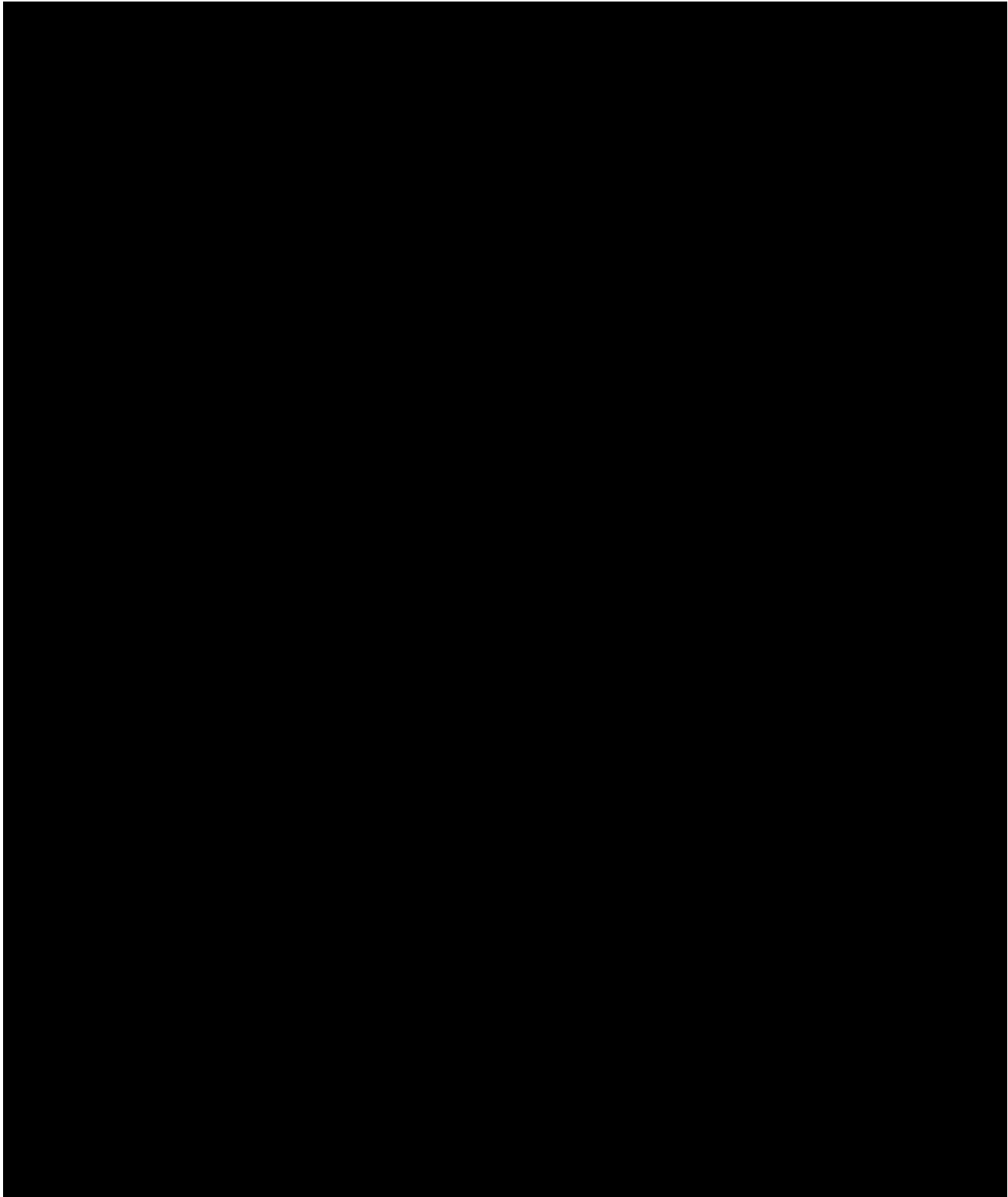
The cables will be cross-linked polyethylene insulated cables. It is anticipated the onshore cable will be transported to site by truck in order to reduce the need for a large staging area for cable laydown. The cable will be installed between manholes at splice vault locations; one reel containing the cable length will be positioned at one manhole and the pulling vehicle with winch will be at the other end manhole of the corresponding duct bank length. Once cables are installed between the vaults, the cables will be spliced together. The supplier will test and commission the cable following cable installation and terminations.

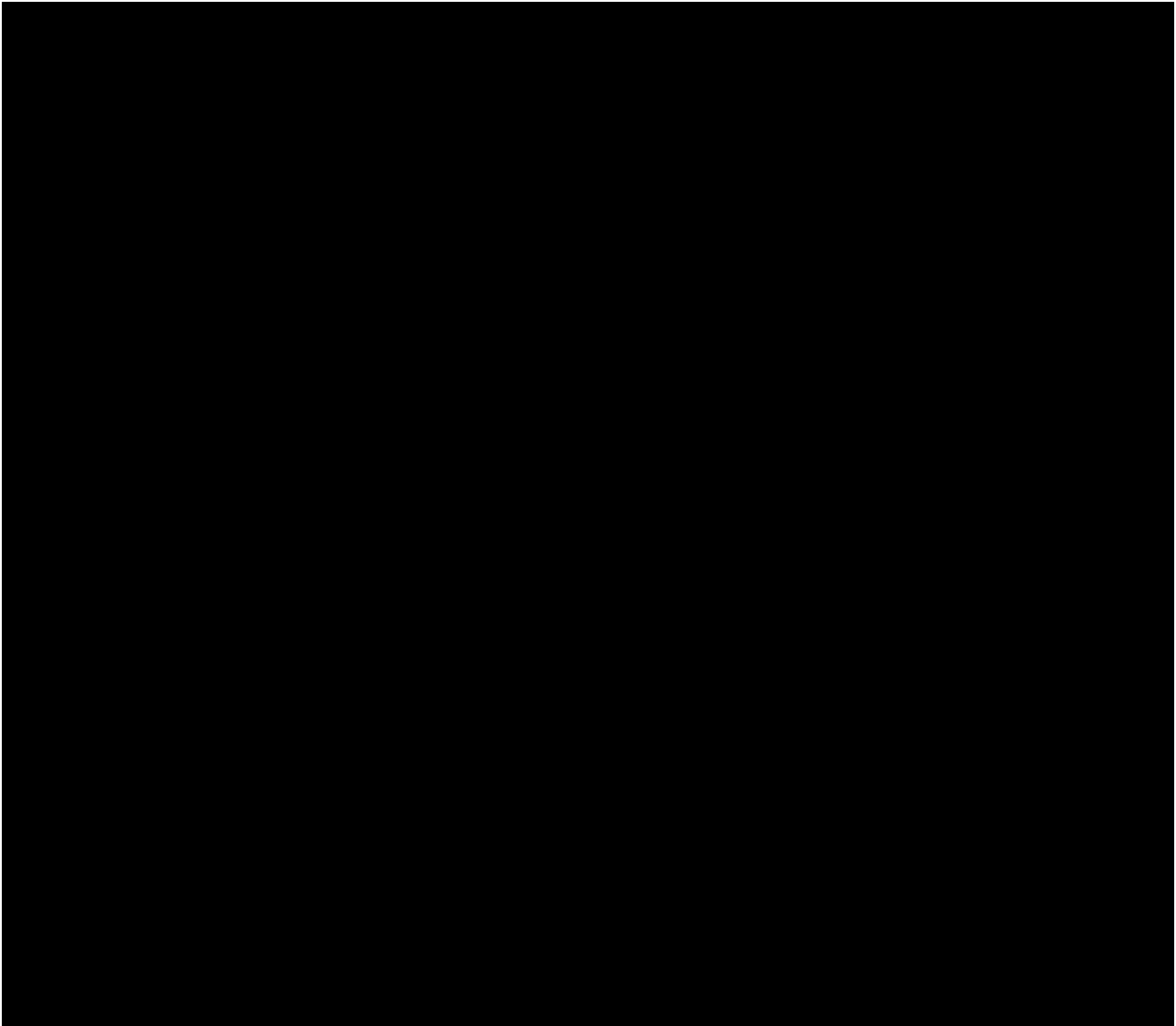
-
4. *Indicate the number, type and size of vessels that will be used, their respective uses, and how vessels will be secured for the required construction period. Explain how Proposer's deployment strategy will conform to requirements of the Merchant Marine Act of 1920 (the Jones Act).*
-

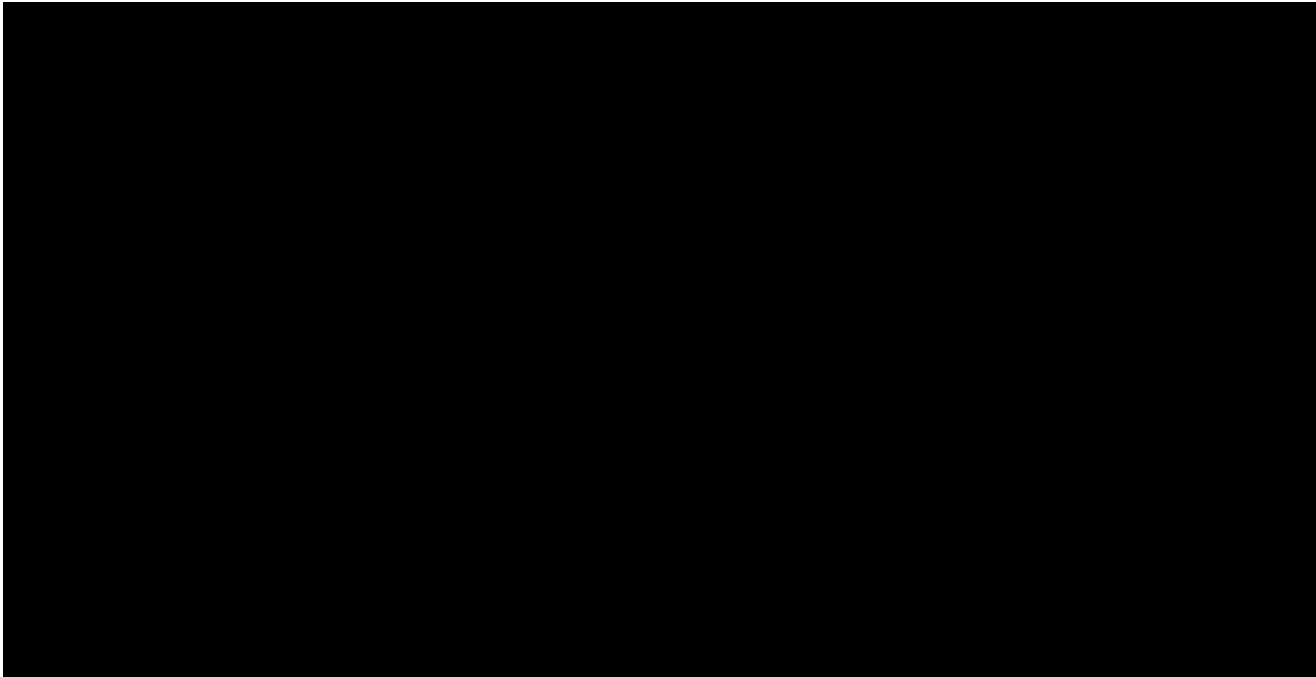
NUMBER, TYPE, AND SIZE OF VESSELS AND THEIR RESPECTIVE ROLES

An overview of vessels (number, type, and size) and respective roles expected to be used for the Project is provided in **Tables 11.4-1, 11.4-2, 11.4-3, 11.4-4 and 11.4-5**. The lists are indicative and non-exhaustive.







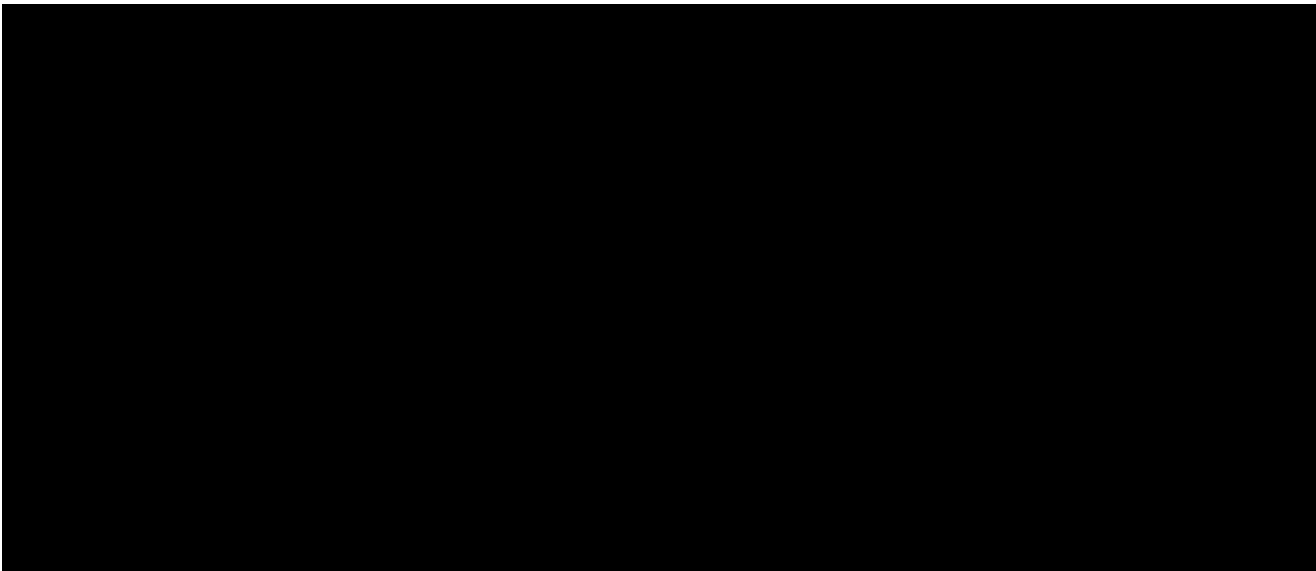


THE COASTWISE LAWS

This section provides specific information on how the Project' deployment strategy will conform to requirements of the Coastwise Merchandise Statute (Jones Act) and the Passenger Vessel Services Act (PVSA).

The installation setup is developed around the main principles of the Jones Act in close cooperation with the potential contractors and vessel owners. Vineyard Wind contracted with law firm Blank Rome to perform a legal review of critical aspects of Vineyard Wind's proposed setup. This legal review confirmed feasibility and compliance with the Jones Act.

The following details the relevant parts of the PVA and court rulings:



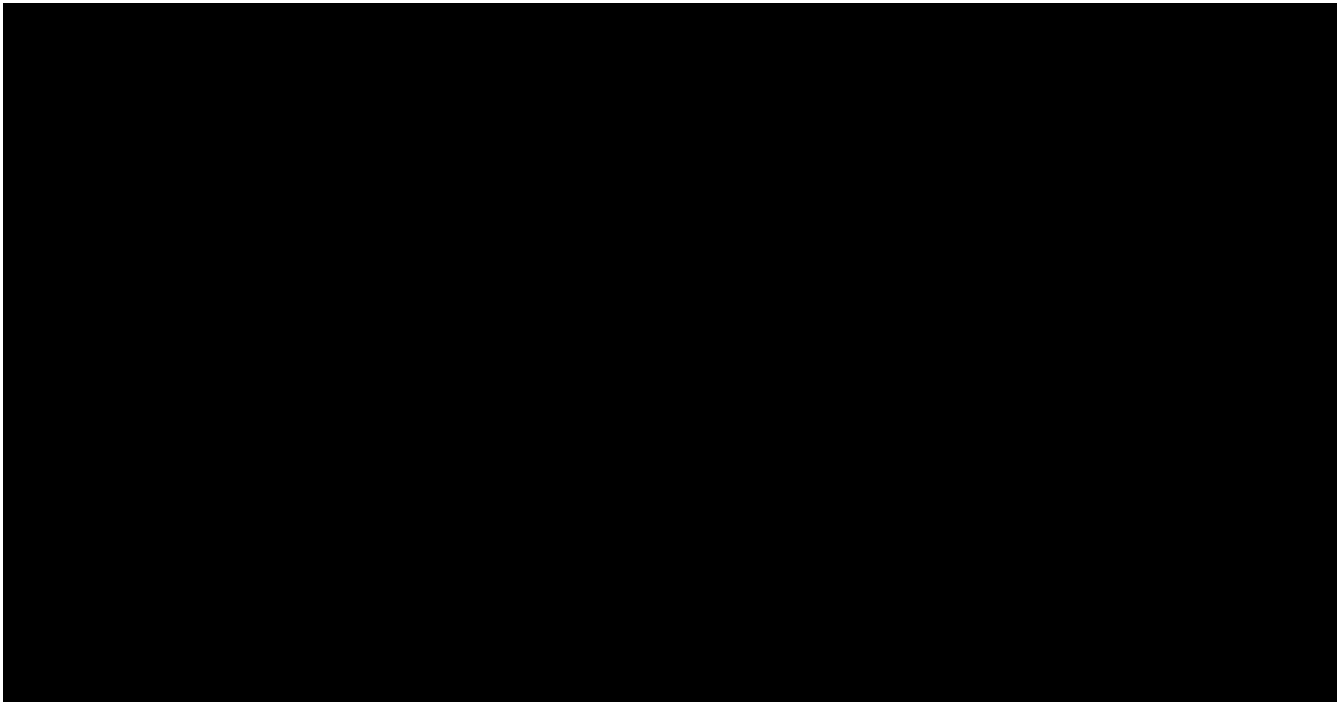
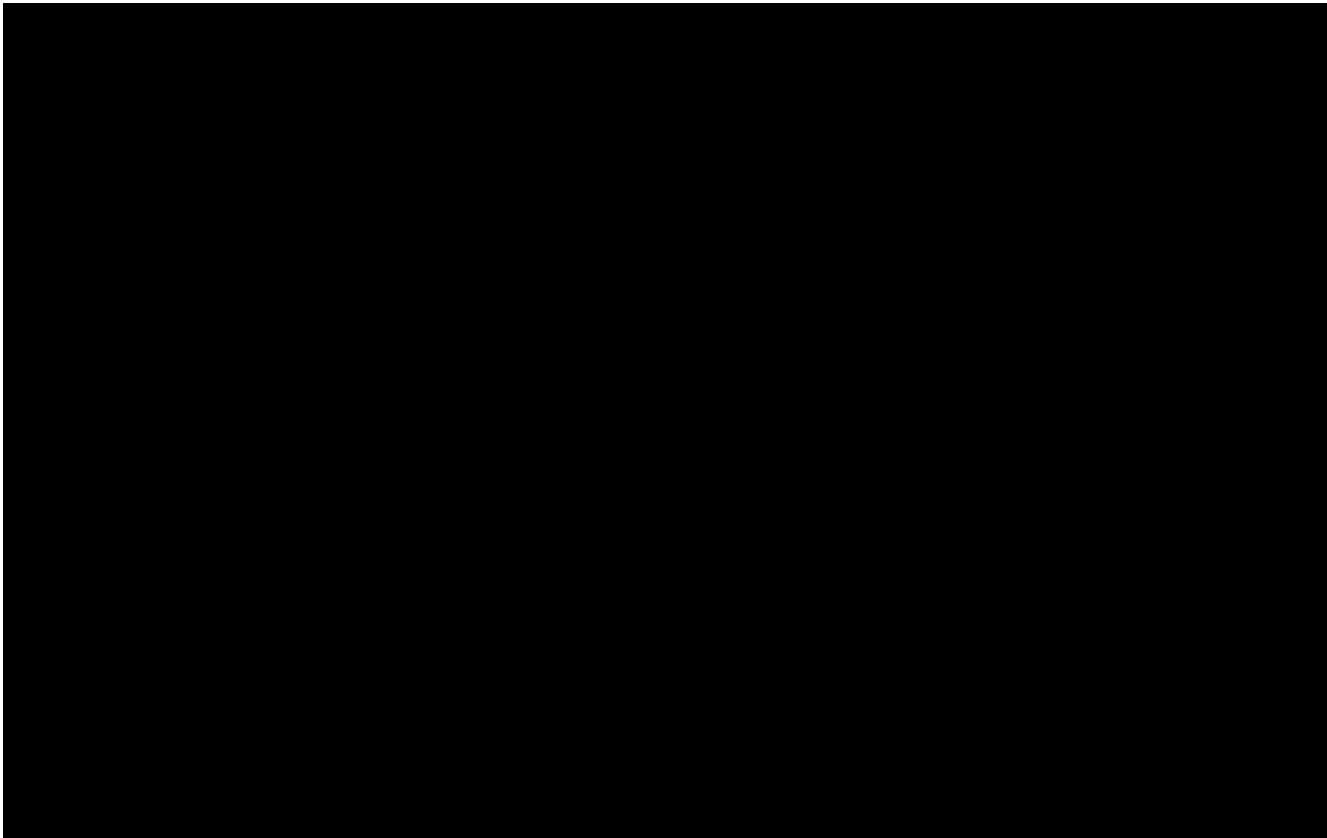
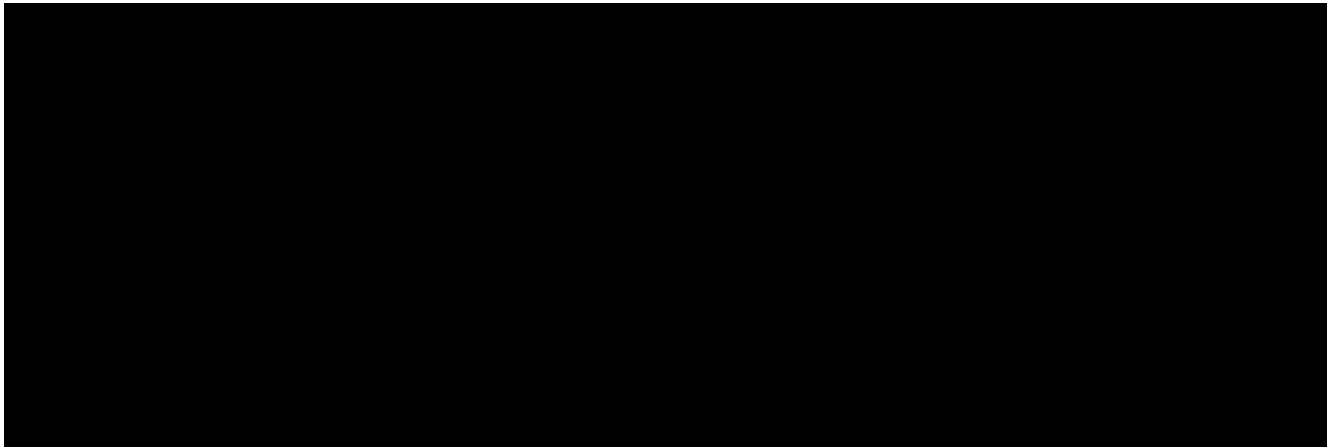


Table 11.4-6 summarizes Vineyard Wind’s approach to compliance with the Jones Act.

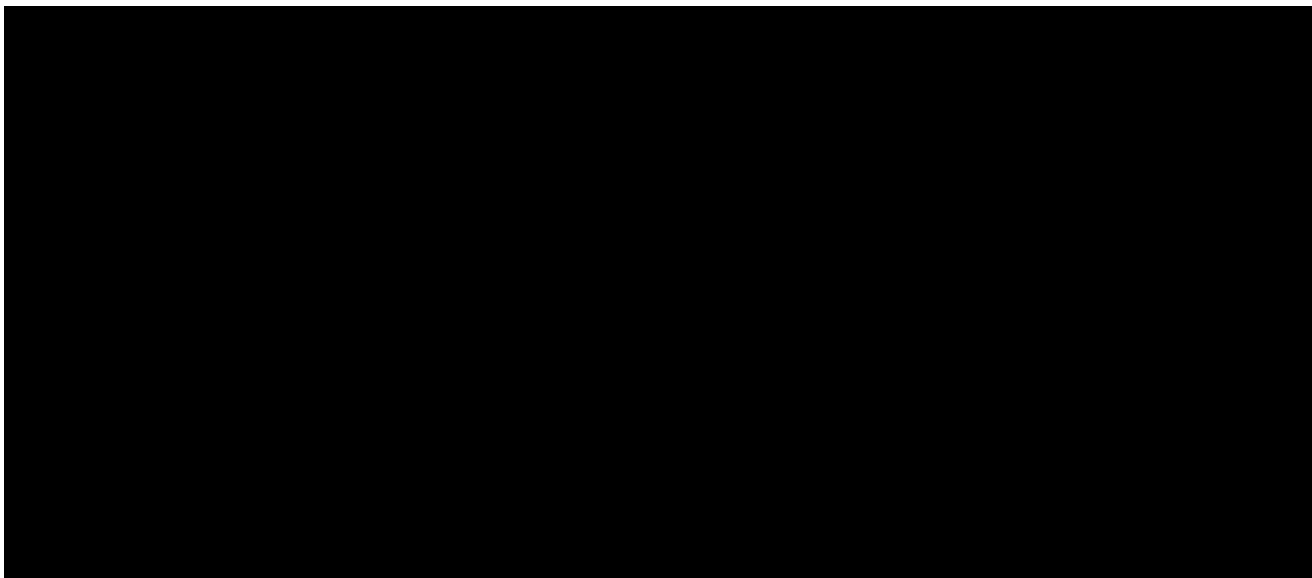


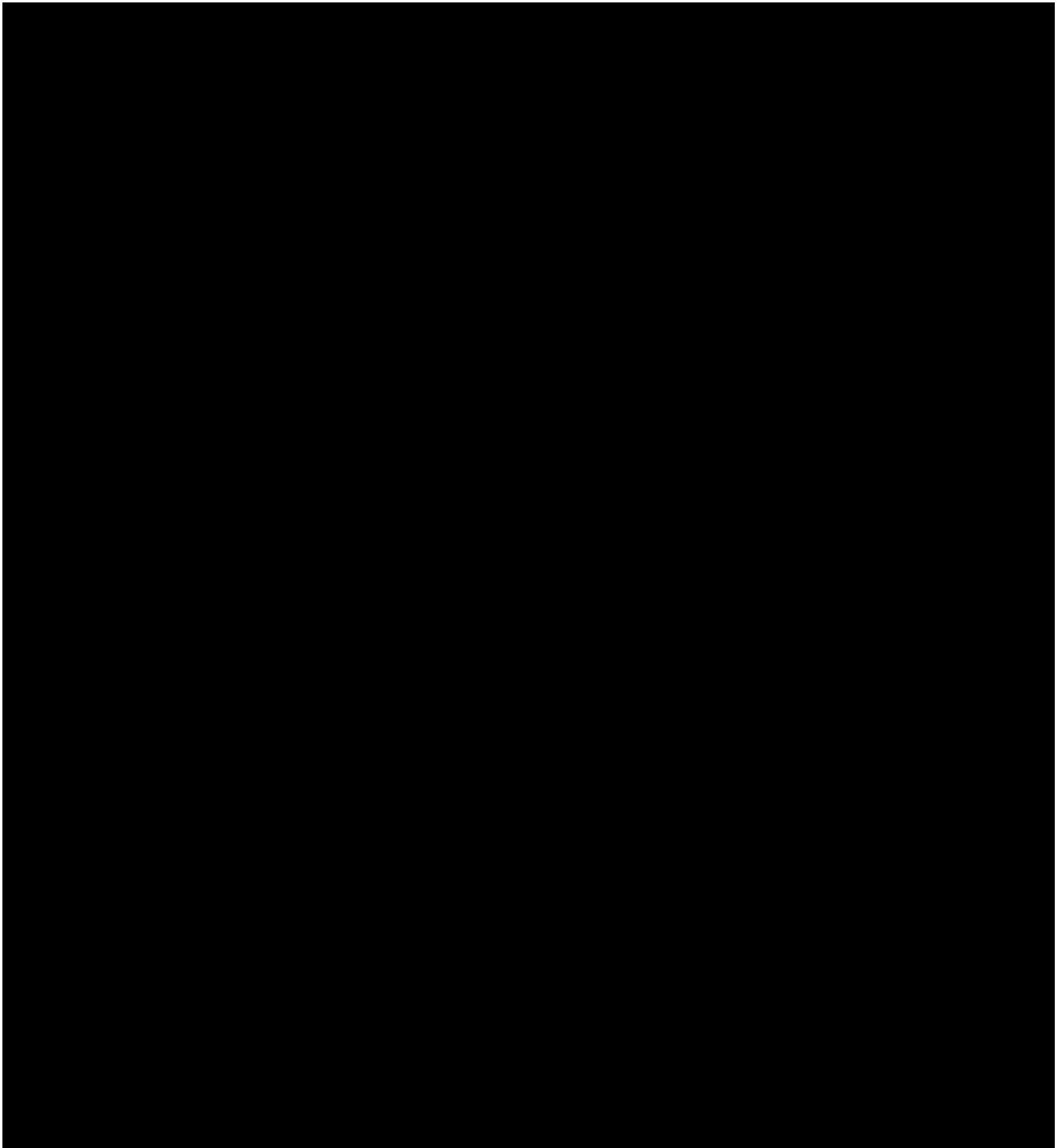


-
5. *List the party or parties responsible for each deployment activity and describe the role of each party. Describe the status of Proposer's contractual agreements with third-party equipment/service providers.*
-

RESPONSIBLE PARTY FOR EACH DEPLOYMENT ACTIVITY AND THE ROLE OF EACH PARTY

Table 11.5-1 provides a list of the potential parties involved in Project deployment along with their scope of responsibility for each of the work package. This list represents the suppliers with whom Vineyard Wind has been in direct dialogue. Second tier suppliers have been approached (such as harbor owners, crane companies, supply vessel, and transport vessel owners) but are not included in the table below and is not to be considered complete as other suppliers could be considered relevant.





CONTRACTUAL AGREEMENTS WITH THIRD-PARTY EQUIPMENT/SERVICE PROVIDERS

Vineyard Wind is currently in final engineering, procurement, and contract negotiations for the largest supply packages for the first 800 MW project. The experience gained from this process, along with the supply chain dialogues that have happened along the way, have been incorporated into the planned procurement process for the Project.

Vineyard Wind will further develop existing relationships with New York, US, and international suppliers as well as detailed engineering concepts with the entire value chain towards procuring and executing contractual agreements for the Project. [REDACTED]

[REDACTED] Equipment orders for the Project will also be made in accordance with the procurement process described in **Section 9**.



LIBERTY WIND

SECTION 12 - FISHING MITIGATION PLAN

Proposal for New York State Energy Research and Development Authority in response to Request For Proposals for Purchase of Offshore Wind Renewable Energy Certificates



Photo: Alamy

SECTION 12 FISHERIES MITIGATION PLAN

12.1 Proposers must include in their Proposal a Fisheries Mitigation Plan in as much detail as possible that describes how Proposer will mitigate adverse impacts on the commercial fishing industry that may be caused by the Project. Elements of the Fisheries Mitigation Plan are described in detail in Appendix D. Proposers are advised to review the Fish and Fisheries Study prepared for the New York State Offshore Wind Master Plan with respect to the potential impacts of offshore wind energy development on the fishing industry, and also are advised to include in their mitigation plan the appropriate Best Management Practices described in the Master Plan and supporting studies.

Vineyard Wind is committed to working with the fishing community so that both the wind and fishing industries can grow and thrive together offshore. This commitment is long-standing, starting with Vineyard Wind engaging the offshore wind industry's first Fisheries Representative in 2010, and will continue through the permitting, construction, operations, and decommissioning of Liberty Wind (the "Project").

CAREFUL SITING AND COLLABORATIVE DEVELOPMENT

Our approach to avoiding, minimizing, restoring, and offsetting potential fisheries impacts of the Liberty Wind can be summarized as follows: **Careful siting and collaborative development**. Careful siting entails developing offshore wind projects so they avoid potential impacts, to the greatest extent possible, from the outset. Collaborative development means working with a range of stakeholders, including the fishing community, before the permitting process begins to refine initial project layouts and design elements to further avoid impacts and/or minimize the risk of impacts when they are unavoidable. Collaborative development also means working with stakeholders to craft solutions that mitigate and offset the Project's impacts. This builds on the approach Vineyard Wind employed with our first 800 MW project, and reflects the lessons learned and experience gained developing the country's first commercial-scale offshore wind farm.

As the Project moves forward, our Fisheries Communication Plan (**Attachment 12.1-2**) will guide outreach and engagement efforts with the fishing community. Throughout all phases of the Project, the principle of early, often, transparent, and pro-active communication and engagement with the fishermen with whom Vineyard Wind shares the waters will always be a top priority. Consistent and coordinated communication with a variety of fisheries stakeholders, including commercial, recreational, and for-hire fishermen, is essential to ensure the successful development of offshore wind projects, minimize potential impacts on fisheries resources and the fishing industry, and develop effective solutions.



LIBERTY WIND

SECTION 13 - ENVIRONMENTAL MITIGATION PLAN

Proposal for New York State Energy Research and Development Authority in response to
Request For Proposals for Purchase of Offshore Wind Renewable Energy Certificates



SECTION 13

ENVIRONMENTAL MITIGATION PLAN

Proposers must include in their Proposals a detailed Environmental Mitigation Plan that describes how Proposer will mitigate adverse environmental impacts that may be caused by the Project. Elements of the Environmental Mitigation Plan are described in detail in Appendix E. Proposers are advised to review the environmental studies prepared for the New York State Offshore Wind Master Plan with respect to the potential impacts of offshore wind energy development on the environment, and also are advised to include in their mitigation plan the appropriate Best Management Practices described in the Master Plan and supporting studies.

The Project will do this while making a substantial contribution to New York's recently announced 9,000 MW offshore wind target.

Vineyard Wind is committed a robust stakeholder engagement process to ensure the final design of the Project and its operation maximizes the environmental benefits of offshore wind and limits potential impacts. Vineyard Wind is keen to develop the Project in a manner that rigorously supports environmental research, conservation efforts, and the development of new tools, methods, and technologies to better ensure effective protection of marine species and habitats. Additional detail can be found in the preliminary Environmental Mitigation Plan, included as **Attachment 13.1-1**.

CAREFUL SITING AND COLLABORATIVE DEVELOPMENT

Vineyard Wind's approach to avoiding, minimizing, restoring, and offsetting potential environmental impacts can be summarized as follows: **Careful siting and collaborative development**. Careful siting entails developing offshore wind projects so they avoid potential impacts, to the greatest extent possible, from the outset. Collaborative development means working with a range of stakeholders before the permitting process begins to refine initial project layouts and design elements to further avoid impacts and/or minimize the risk of impacts when they are unavoidable. Collaborative development also means working with stakeholders to craft solutions that mitigate and offset potential environmental impacts. This builds on the approach Vineyard Wind employed with our first

¹ See e.g., NYSERDA's estimated emission reduction potential for 2,400 MW of offshore wind capacity in New York. Available at: <https://www.nyseda.ny.gov/All-Programs/Programs/Offshore-Wind/Offshore-Wind-in-New-York-State-Overview/Benefits-of-Offshore-Wind>.

800 MW project, and reflects the lessons learned and experience gained developing the country's first commercial-scale offshore wind farm.

- The Massachusetts Wind Energy Area, where the Project will be located, is an environmentally superior location to build an offshore wind project in terms of avoiding harm and minimizing potential impacts.

Throughout every phase of the Project, Vineyard Wind is committed to working with environmental stakeholders, supporting research to address data gaps, and taking steps to implement appropriate mitigation measures to offset Project impacts that cannot be avoided through careful siting and collaborative design. This commitment is perhaps best exemplified by the agreement that Vineyard Wind has entered into with the Natural Resources Defense Council, National Wildlife Federation, and Conservation Law Foundation to ensure protection of the critically-endangered North Atlantic Right Whale (*Eubalaena glacialis*) during construction and operation of our first 800 MW project (see **Attachment 13.1-3**). Among other things, this historic and unprecedented agreement clearly demonstrates that Vineyard Wind's project development philosophy is firmly centered on the responsible and sustainable use of the nation's offshore wind resources.



LIBERTY WIND

SECTION 14 - COMMUNITY OUTREACH PLAN

Proposal for New York State Energy Research and Development Authority in response to Request For Proposals for Purchase of Offshore Wind Renewable Energy Certificates



SECTION 14 COMMUNITY OUTREACH PLAN

14.1 Provide a community outreach plan that identifies proposed stakeholder engagement activities during construction and operation of the Project. Provide copies of any agreements with communities and other constituencies impacted by the Project, not already covered in the Fisheries Mitigation Plan or the Environmental Mitigation Plan. Discuss the status of implementing the community outreach plan.

[REDACTED]

The Community Outreach Plan (**Attachment 14.1-1**) for the Project builds on each company's record of successfully engaging communities and organizing project support that provides a high degree of assurance that communities impacted by the Project will support it. Among other things, a strong base of support for the Project will ensure that it can be permitted and constructed in a timely manner.

Vineyard Wind's very early stakeholder initiative, which has been underway for almost a decade, has been very effective in generating community support for offshore wind. As a result of this initiative, Vineyard Wind's first 800 MW project enjoys substantial community support across Massachusetts. Behind Vineyard Wind's successful outreach efforts is a local outreach team comprised largely of community organizing, and campaign veterans who have spent years working for environmental non-profits, community organizations, elected officials, and political campaigns in the region. Another key factor driving support for the project is Vineyard Wind's commitment to delivering tangible benefits to the local and regional economy.

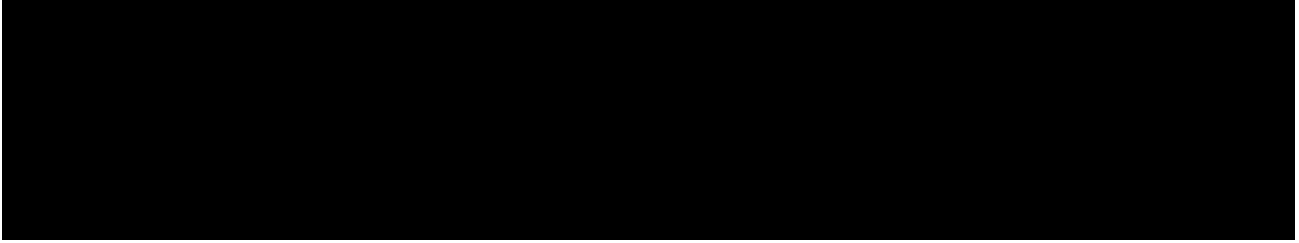
[REDACTED]

Below we describe the community outreach activities of each development partner to-date. The Community Outreach Plan further describes stakeholder engagement activities during the Project's site assessment, construction, and operations phases.

COMMUNITY OUTREACH PLAN

This RFP, New York State's first procurement for hundreds of megawatts of offshore wind, constitutes the first major step in the transformation of the State's generation fleet toward the

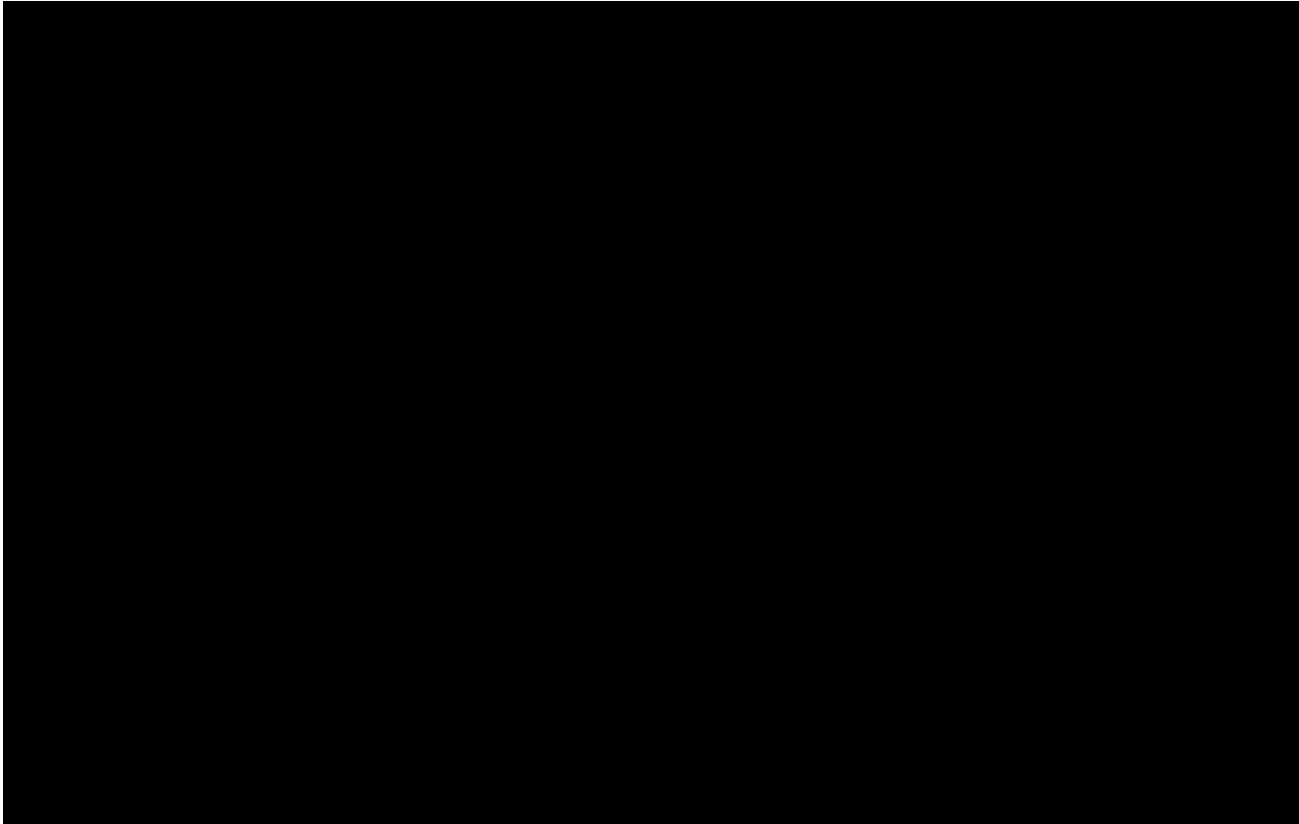
ultimate goal of 9,000 MW of offshore wind – and locating the heart of that industry and its supply chain in New York. In this context, the Project’s community outreach plan takes on a dual mission.

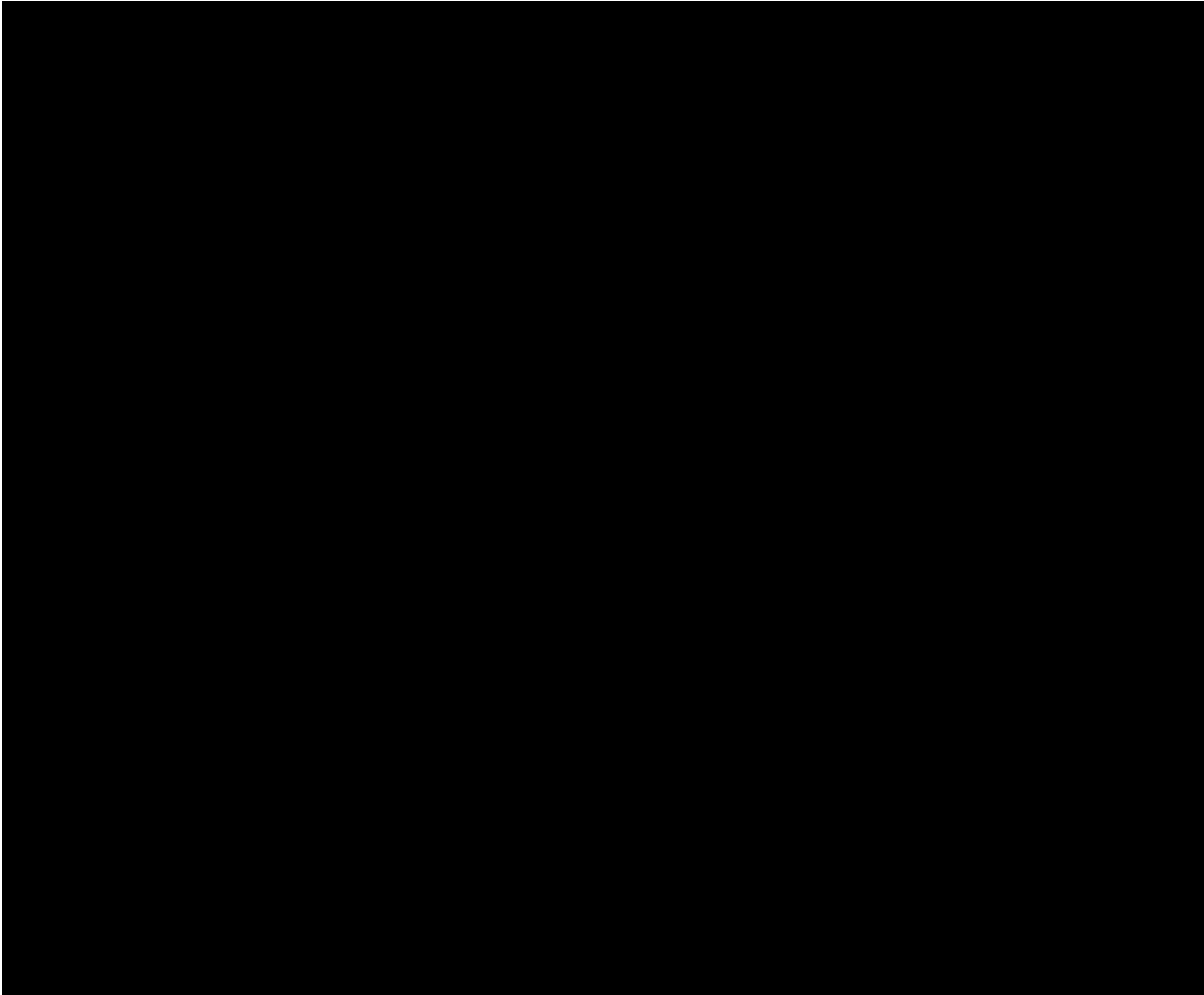


VINEYARD WIND’S ENGAGEMENT ACTIVITIES

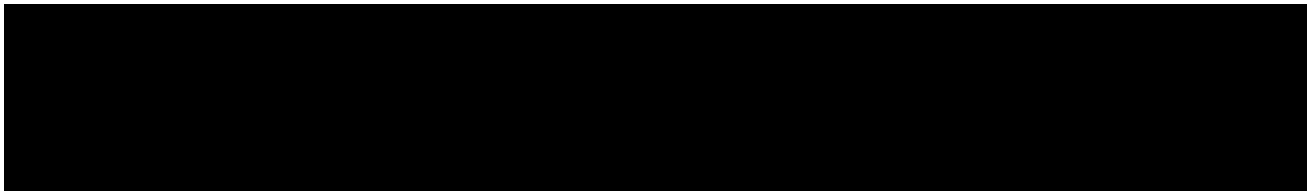
Vineyard Wind’s outreach efforts started in 2009 and have intensified significantly in the past three years as the company’s first 800 MW project has moved into the permitting phase and successfully bid into Massachusetts’ Section 83C offshore wind procurement. Vineyard Wind is in daily contact with a wide array of federal, state, fisheries, community, and environmental stakeholders.

To demonstrate the level of engagement, Vineyard Wind has compiled a list of the federal, state, and local municipality meetings, as well as meetings with local tribes, that Vineyard Wind has conducted in recent years (see **Attachment 14.1-2**). These meetings are in addition to regular calls and emails to inform and involve these parties in the development of the permitting documents for the first 800 MW project. Many of these stakeholders will be the same for the Project. **Attachment 14.1-2** also provides a summary list of stakeholders that Vineyard Wind has proactively engaged over the last three years.





14.2 Provide documentation identifying the level of public support for the Project including letters from public officials, newspaper articles, etc. Include information on specific localized support and/or opposition to the Project of which Proposer is aware.



SUPPORT FOR VINEYARD WIND IN THE COMMUNITY

For Vineyard Wind, the company has been working for the better part of a decade to build support for the country's first commercial-scale offshore wind farm. The support letters included as **Attachment 14.2-1** speak to the success of Vineyard Wind's community early outreach efforts in New York and our sincere commitment to working with local communities to develop responsibly-

sited offshore wind projects. These letters come from a variety of stakeholders, including state legislators, chambers of commerce, business development groups, solar companies, environmental organizations, and private citizens in Massachusetts and Rhode Island. Excerpts from some of the support letters, submitted during recent public comment periods for the first 800 MW project on the federal and state level, follow:

"[Citizens Campaign for the Environment] supports Vineyard Wind advancing offshore wind in New York and bringing their expertise and commitment to ocean protection and stakeholder engagement."

- Adrienne Esposito, Citizens Campaign for the Environment

"The creation of a major new industry such as offshore wind in the public domain is a major undertaking for sure. It is impossible to predict any and all circumstances that will occur as we launch this new industry. For that reason, we believe that Vineyard Wind is an excellent partner. They have demonstrated a sound commitment to incumbent industries, the environment, and minimizing impacts to the ocean environment. We believe they will continue this commitment throughout the project's development and operation."

- Wendy Northcross, CEO, Cape Cod Chamber of Commerce

"[We have] carefully followed and been impressed by Vineyard Wind's efforts to mitigate project impacts and address community concerns."

- Moncrieff Cochran, Executive Director, Cape Cod Climate Change Collaborative

"We are pleased to see that Vineyard Wind has made every effort to reduce the environmental impacts on local communities and to address the concerns of those in the fishing industry who feel they might be adversely affected. Vineyard Wind has listened to these concerns and taken steps to alleviate them."

- Dorothy McIver, Greening Greenfield

"Vineyard Wind is committed to responsible renewable energy project development as evidenced by the recently announced agreement with environmental organizations to protect the critically-endangered North Atlantic right whale."

- Alex Papali, Clean Water Action

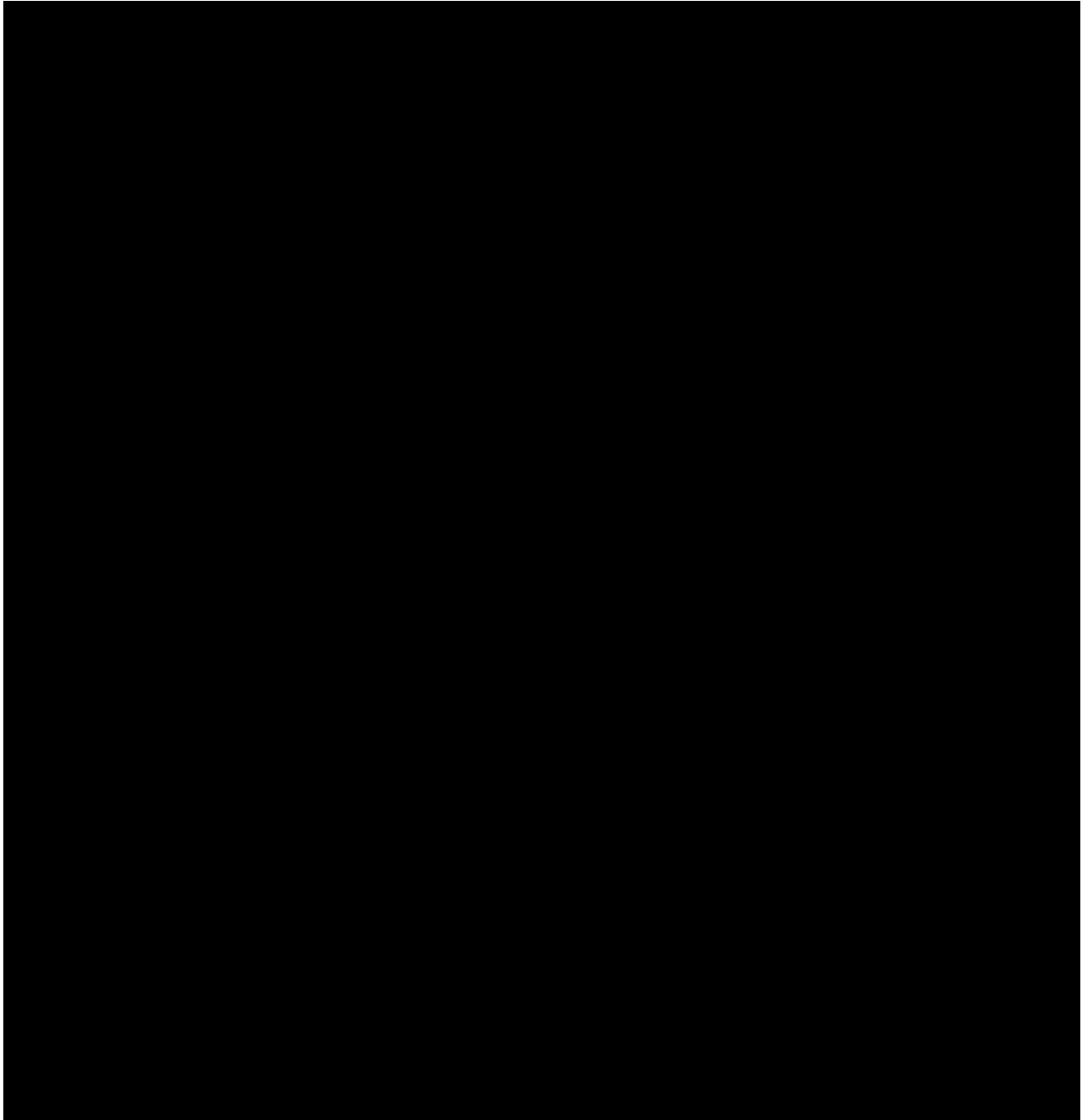
Vineyard Wind also spends a great deal of time in the community organizing, attending, speaking at, and sponsoring events. Vineyard Wind believes this kind of engagement is not only important to build support for projects but is a necessary part of being a good corporate citizen.

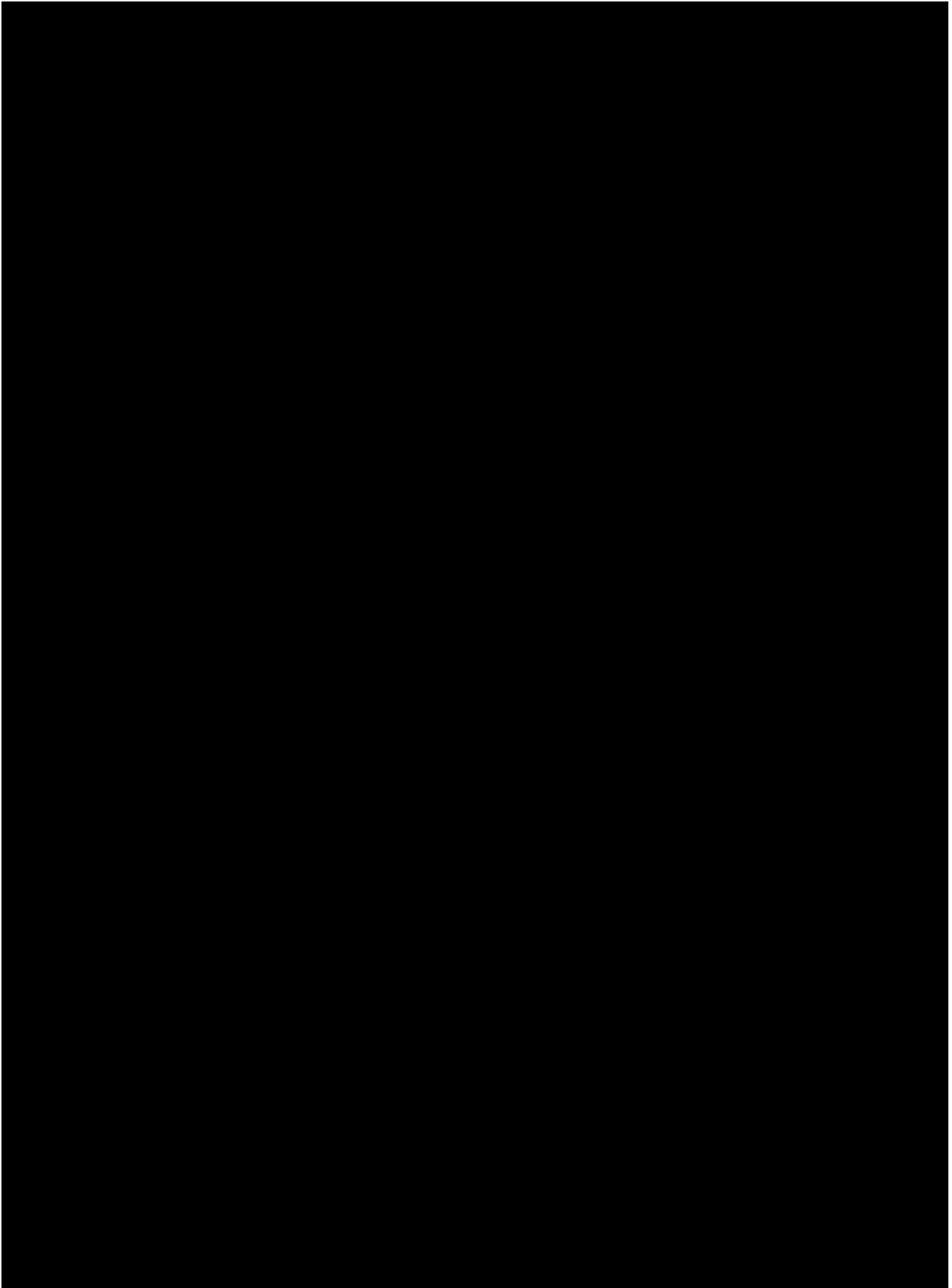
The Vineyard Wind quarterly newsletters included as **Attachment 14.2-2** showcase the range of events that staff at all levels of Vineyard Wind participate in on a regular basis. These include career fairs for high school students, speaking at community roundtables on climate change, sponsoring fisheries-related trade shows, and organizing events aimed at increasing consumer awareness around renewable energy and electric vehicle transport solutions.

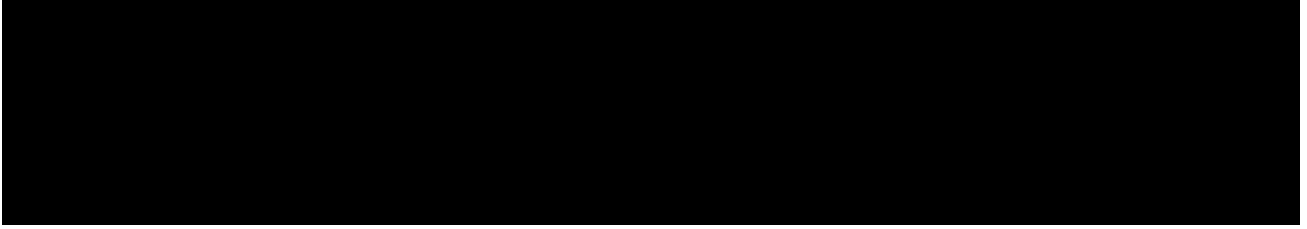
Vineyard Wind in the Media

Vineyard Wind's efforts to build the country's first commercial-scale offshore wind project has also attracted significant media coverage. The vast majority of this coverage has been positive. News stories of note discuss the project's competitive pricing, community agreements, achievement of important project milestones, and the recent announcement by a wind turbine manufacturer to locate its US headquarter in Boston. A selection of news stories about Vineyard Wind is included as **Attachment 14.2-3**.

SUPPORT FOR ANBARIC IN THE COMMUNITY









LIBERTY WIND

SECTION 15 - VISIBILITY AND VIEWSHED IMPACTS

Proposal for New York State Energy Research and Development Authority in response to Request For Proposals for Purchase of Offshore Wind Renewable Energy Certificates



SECTION 15 VISIBILITY AND VIEWSHED IMPACTS

15.1 Proposers must address a Project's visibility from shore. If a Project is proposed to include turbines less than 20 statute miles from the nearest shoreline point of any state, Proposers must explain (i) how the Project will minimize adverse impacts related to visibility of turbines, including potential impacts on the local and state economy and historic and visual resources, such as publicly-accessible viewsheds, and (ii) how consideration of economic and environmental concerns contributed to the proposed distance from shore.

Liberty Wind (the "Project") is an offshore wind project that Vineyard Wind is proposing to build in federally designated Lease Area OCS-A 0522 (the "Lease Area"), which is located over the horizon and approximately 85 miles (mi) east of Montauk, Long Island. The Project is comprised of an Offshore Wind Generation Facility and the transmission required for a direct interconnection to the New York Control Area on Long Island.

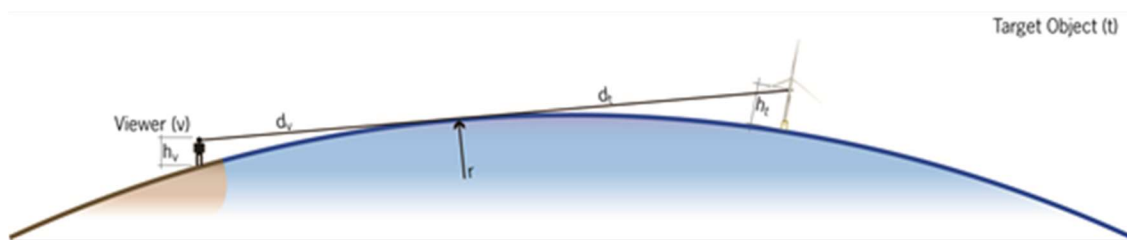
As further described in this section, all of the Project's wind turbine generators (WTGs):

- Will not be visible from any land-based location in New York, and
- Will be located more than 20 statute miles from the nearest shore.

Visibility from New York

Liberty Wind's Offshore Wind Generation Facility will be located approximately 85 mi from New York. At such an extended distance, due to the curvature of the earth, all of the WTGs in the Offshore Wind Generation Facility fall well-below the horizon and will not be visible from any land-based vantage point in New York.

Figure 15.1-1 Geometric Horizon Diagram



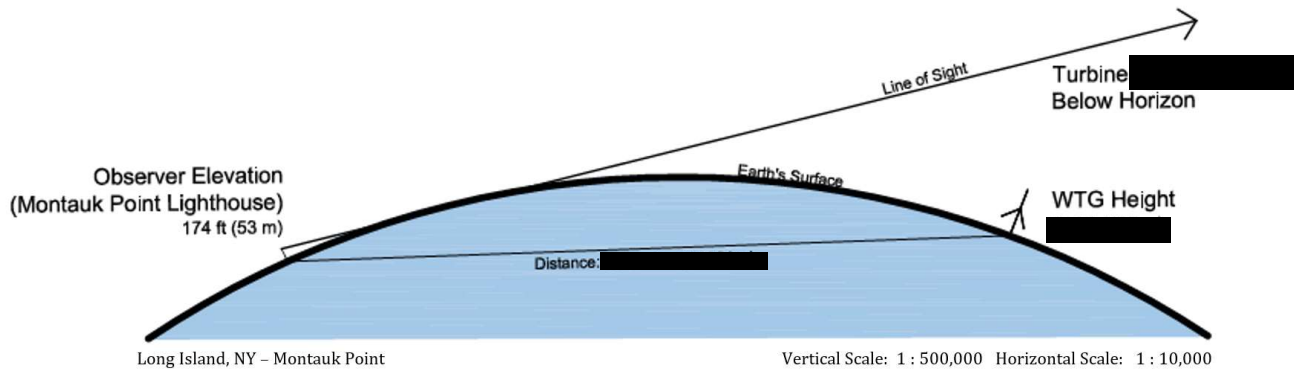
The extent to which the WTGs fall below the horizon from the nearest land-based vantage point in New York- Montauk, Long Island- can be geometrically calculated using the Pythagorean Theorem ($a^2+b^2=c^2$). The distance that the target object (t) will become visible above the horizon from a known vantage point is the sum of the distance between from the viewer location to the visible horizon (d_v) and the distance from the target object to the visible horizon (d_t). The calculation

performed for Liberty Wind conservatively estimates the visibility of the WTGs in the Offshore Wind Generation facility as it includes a correction factor for atmospheric refraction. See **Attachment 15.1-1** for an explanation of the curvature of the earth calculation.

Table 15.1-1 shows how much of a WTG would fall below the visible horizon at different distances and viewer elevations, and demonstrates that as distance increases the portion of the WTG (e.g., nacelle and rotor blade tip) visible above the horizon decreases exponentially. From the closest land-based vantage point on Nantucket Island (approximately 30 mi), for a standing observer at beach elevation (assume 12 feet [ft] above sea level), only the upper 251 ft (of 614 ft in total) of the WTG will be *mathematically* visible above the horizon. At 38 mi, the entire rotor blade of the nearest WTG will fall below the visible horizon as viewed from beach elevation.

For New York, which is located almost three times the distance from the Offshore Wind Generation Facility at its closest point as Nantucket Island, the WTGs will not be visible from any land-based vantage point. For example, from the Montauk Point Lighthouse (174 ft above sea level), the nearest WTG in the Offshore Wind Generation Facility falls almost 2,000 ft below the horizon (see **Figure 15.1-2**).

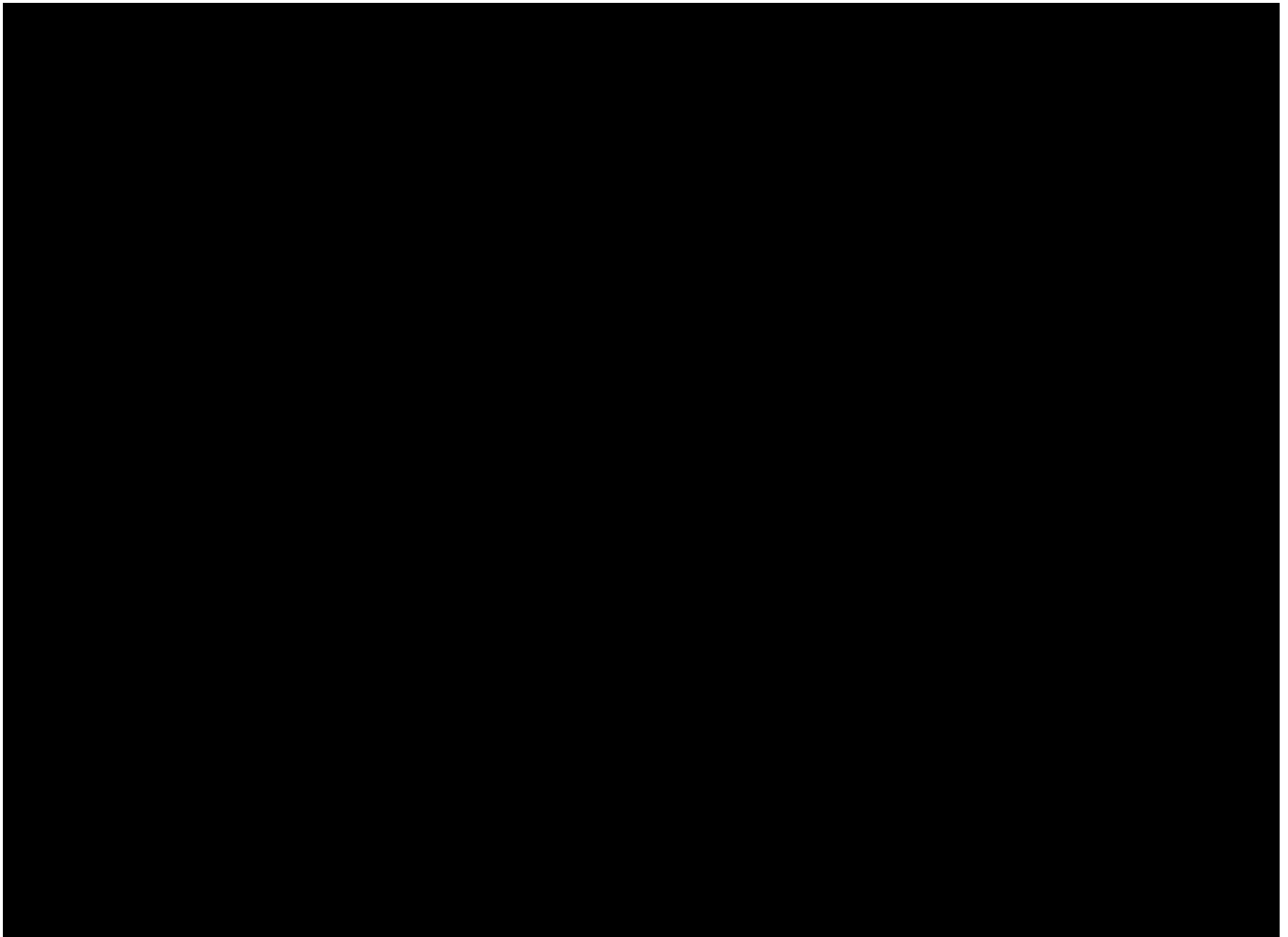
Figure 15.1-2 *Liberty Wind WTG Visibility from Montauk*

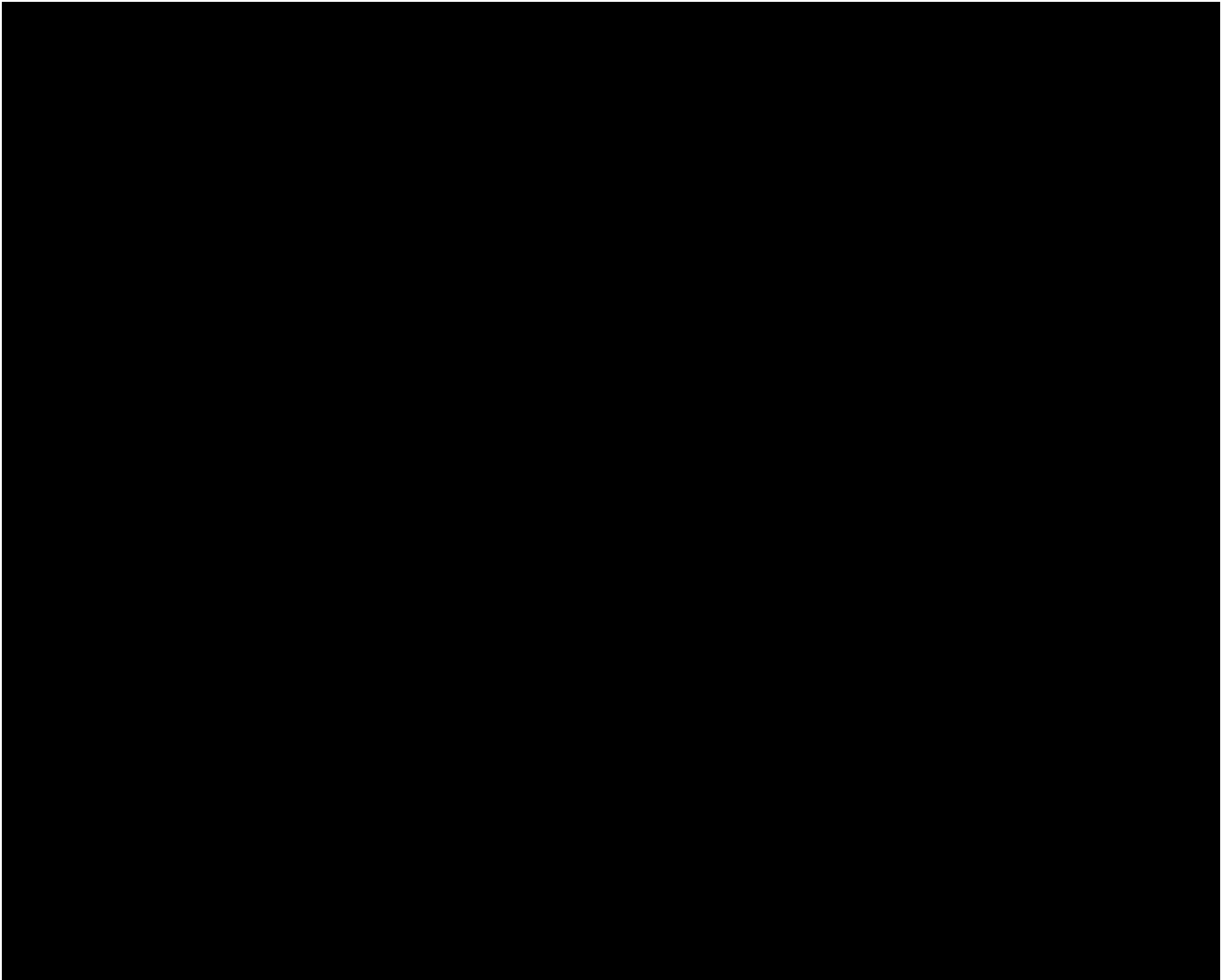


Distance from the Nearest Shoreline

The Offshore Wind Generation Facility will be installed in Lease Area OCS-A 0522, a 132,370-acre area in the open Atlantic Ocean. The Lease Area is located south/southeast of Martha’s Vineyard and Nantucket and southeast of Vineyard Wind’s first Lease Area OCS-A 0501 (see **Figure 15.1-3**). [REDACTED]

Based on preliminary layout for the Offshore Wind Generation Facility, all WTG positions are well over 20 statute miles from the nearest shoreline on Nantucket (see **Figure 15.1-2**); the closest potential WTG position in the lease area is located more than 30 mi away. The closest potential WTG position to Martha’s Vineyard in the lease area will be almost 40 mi away from shore; and the closest potential WTG position to New York in the lease area is approximately 85 mi away. [REDACTED]





15.2 *Additionally, all Proposals, regardless of distance from the nearest shoreline, must include a visibility study that presents visual simulations of the proposed Offshore Wind Generation Facility. Visibility studies must include a map or maps along with supporting GIS shape files that depict the nearest coastline, the boundary of the proposed site to be developed and any other reasonable reference points (e.g. coastal cities, historic sites, other wind energy areas). Simulations must be single frame, photographic images with superimposed simulations of the proposed wind turbine technology configured to represent a commercially-scaled and technically feasible scenario that is consistent with the proposed Project including operating capacity, wind turbine size, and generic spacing and configuration. Viewing instructions must be included on each simulation.*

Visual simulations must represent, at a minimum, clear, partly cloudy, and overcast conditions during early morning, mid-afternoon, and late day, as well as one simulation at night with the turbines lit under clear conditions. Visual simulations must be provided from a minimum of two representative vantage points which represent the closest points to shore from any turbine within the Offshore Wind Generation Facility and, if applicable, any sensitive or historic viewpoints within 20 statute miles of the nearest turbine. The visibility study must also include analysis of the percentage of time during which different visibility conditions are expected to occur based on past meteorological data.

The simulations must be provided in a format suitable to be printed or electronically viewed by the public and/or the Scoring Committee.

INTRODUCTION

The Offshore Wind Generation Facility will be located in Lease Area OCS-A 0522 and more than 30 mi from the nearest shoreline. At this great distance, only a portion of the WTGs in the Offshore Wind Generation Facility are potentially visible from Nantucket. Of those, there is no land-based vantage point that will view an entire WTG. The only visible portions of the WTGs will be the blade tips; these are likely to be virtually undetectable under most daytime viewing conditions and undetectable at night. The highest potential visibility is likely to occur during the daytime in the spring, with the lowest potential visibility occurring in the fall, summer, and winter months.

The photographic simulations included in this section confirm the very limited visual and viewshed impacts the Offshore Wind Generation Facility. [REDACTED]

[REDACTED]



[REDACTED]

PROJECT DESCRIPTION

The Project's Offshore Wind Generation Facility will consist of offshore WTGs, each placed on a foundation support structure, offshore and onshore converter stations, offshore and onshore cabling, and an onshore substation. [REDACTED]

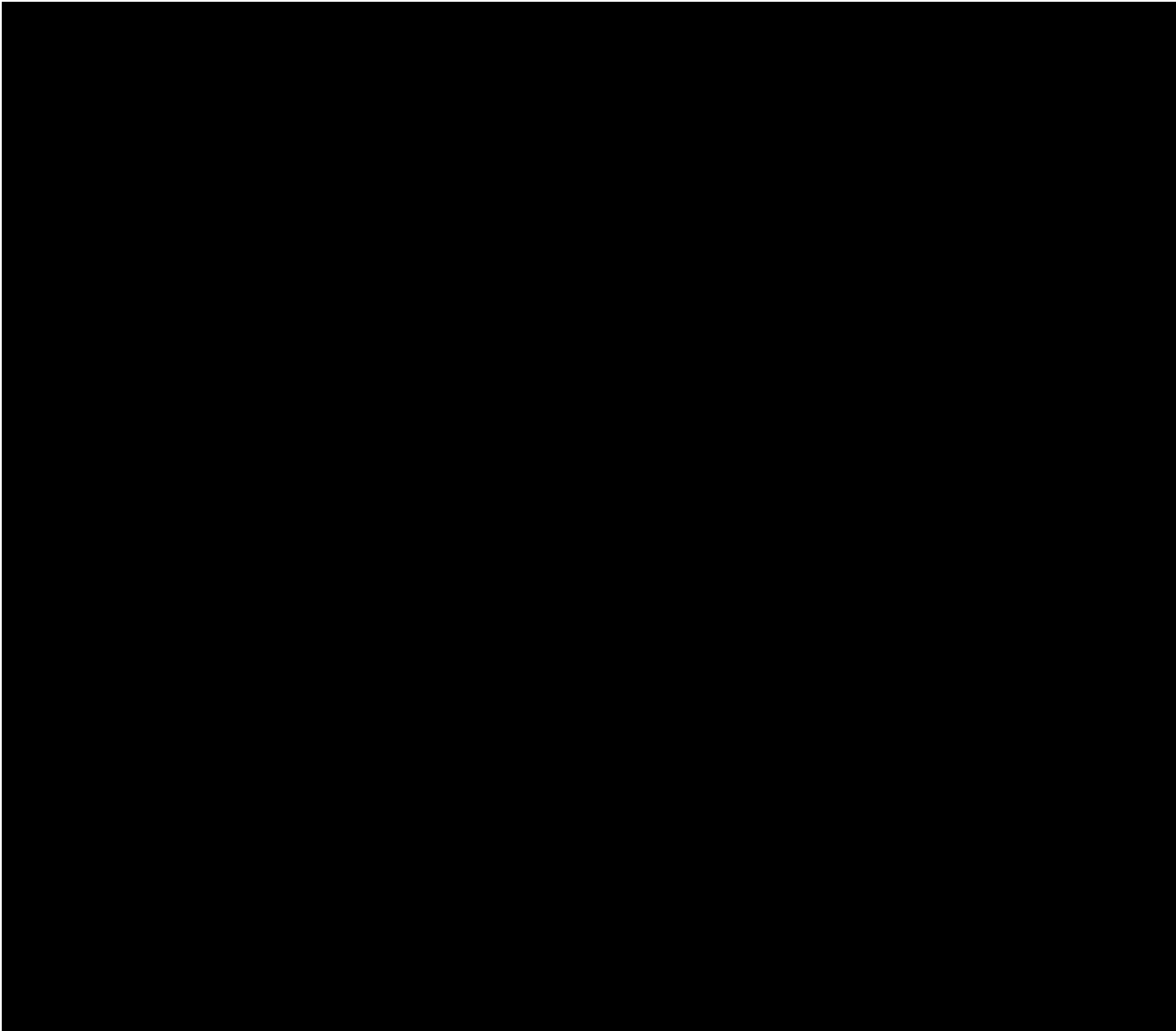
[REDACTED]

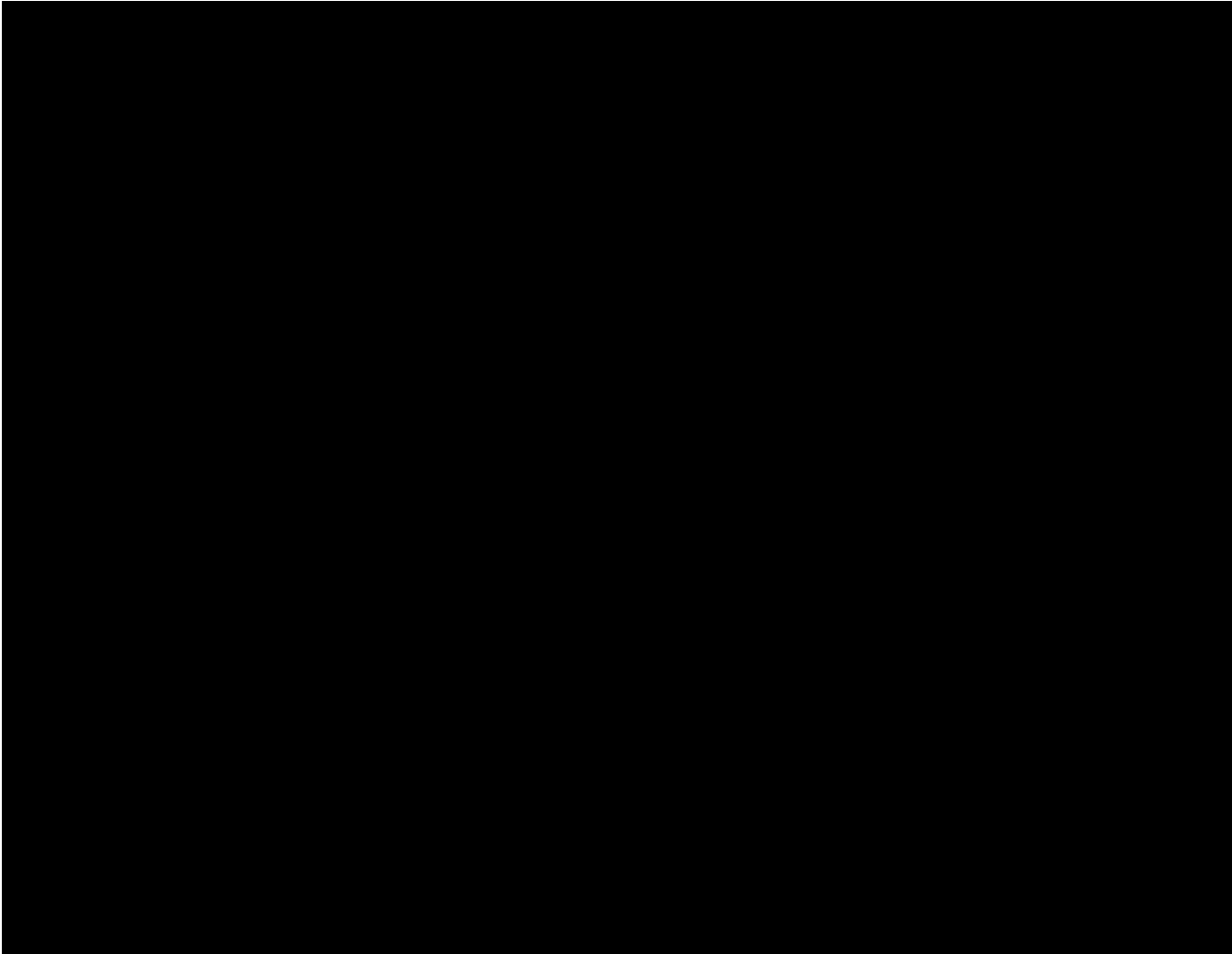


 The WTGs will connect to the existing mainland power grid via inter-array cables that connect WTGs to the offshore electrical service platform (ESP), then offshore cables from the ESP will connect to the shore at the landfall site.


METHODOLOGY

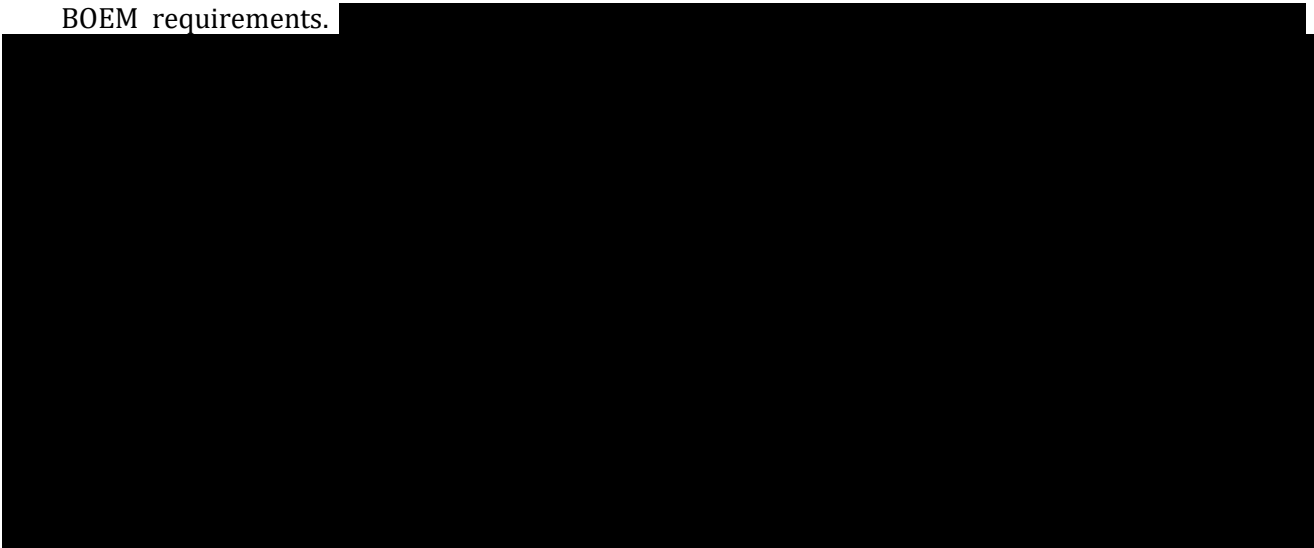
WTG Layout and Specifications Used for Photographic Simulations





Lighting Controls

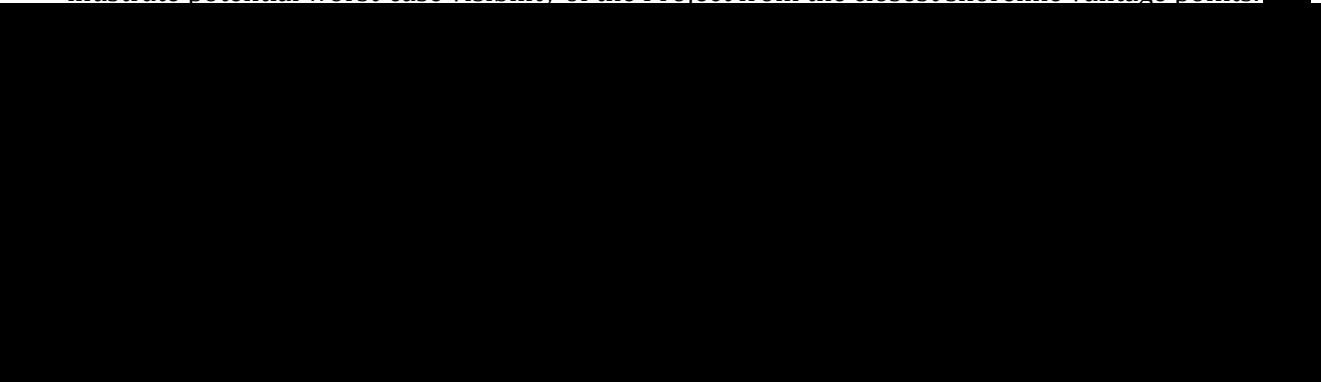
The WTGs will include a night-time wind turbine obstruction lighting system in compliance with BOEM requirements.



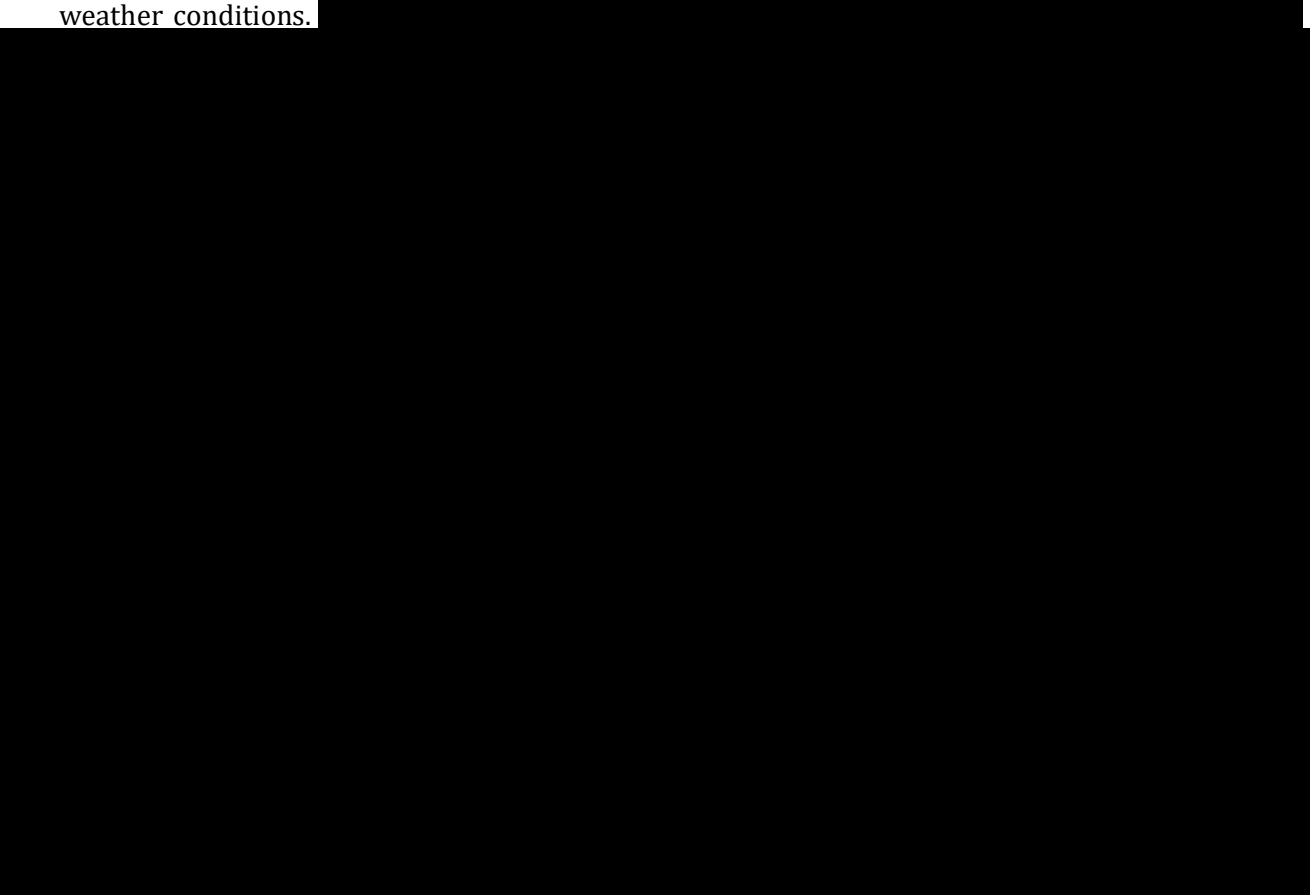


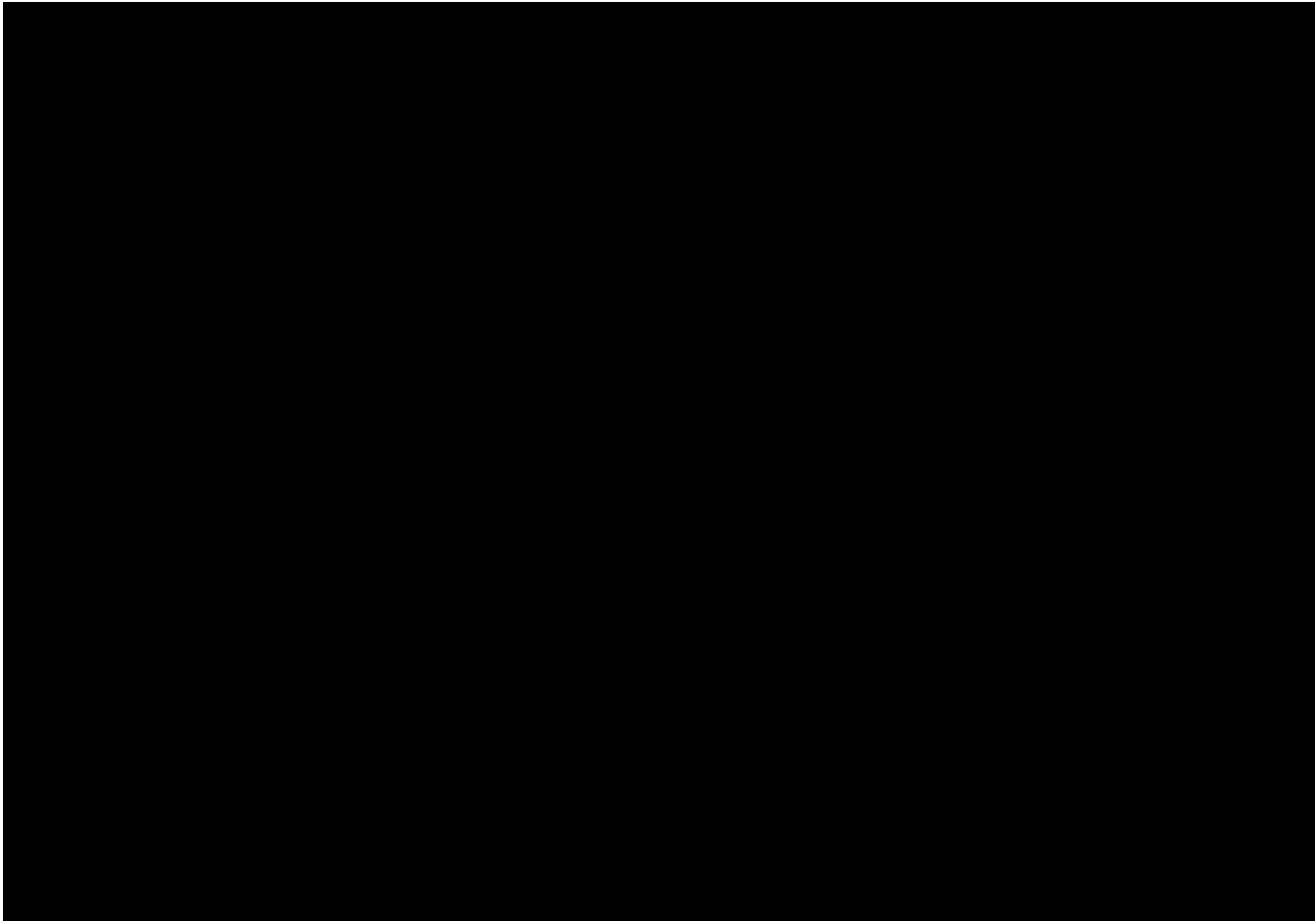
Photographic Simulations

Photographic simulations of the proposed Offshore Wind Generation Facility site are provided to illustrate potential worst-case visibility of the Project from the closest shoreline vantage points.



For both vantage points, photographic simulations represent the following conditions; clear, partly cloudy and overcast weather conditions during early morning, mid-afternoon and late day light conditions. A photographic simulation was also prepared illustrating a nighttime view under clear weather conditions.





Viewing Instructions

The single frame photo simulations have been formatted to be printed on an 11"x17" page format. At this image size, the page should be held at approximately arm's length¹ so that the scene appears at the correct scale. Viewing the image closer would make the scene appear too large, and viewing the image from a greater distance would make the scene appear too small compared to what an observer would actually see in the field.

For viewing photo simulations at other page sizes (i.e., computer monitor, projected image or other hard copy output) the viewing distance/page width ratio is approximately 1.5/1. For example, if the simulation was viewed on a 42-inch-wide poster size enlargement, the correct viewing distance would be approximately 63 inches (5.25 ft).

¹ Viewing distance is calculated based a 39.6-degree field-of-view for the 50mm camera lens used, and the 15.5-inch-wide image presented in **Attachment15.2-1**. "Arm's length" is assumed to be approximately 22.5 inches from the eye. Arm lengths vary for individual viewers.

METEOROLOGICAL ANALYSIS

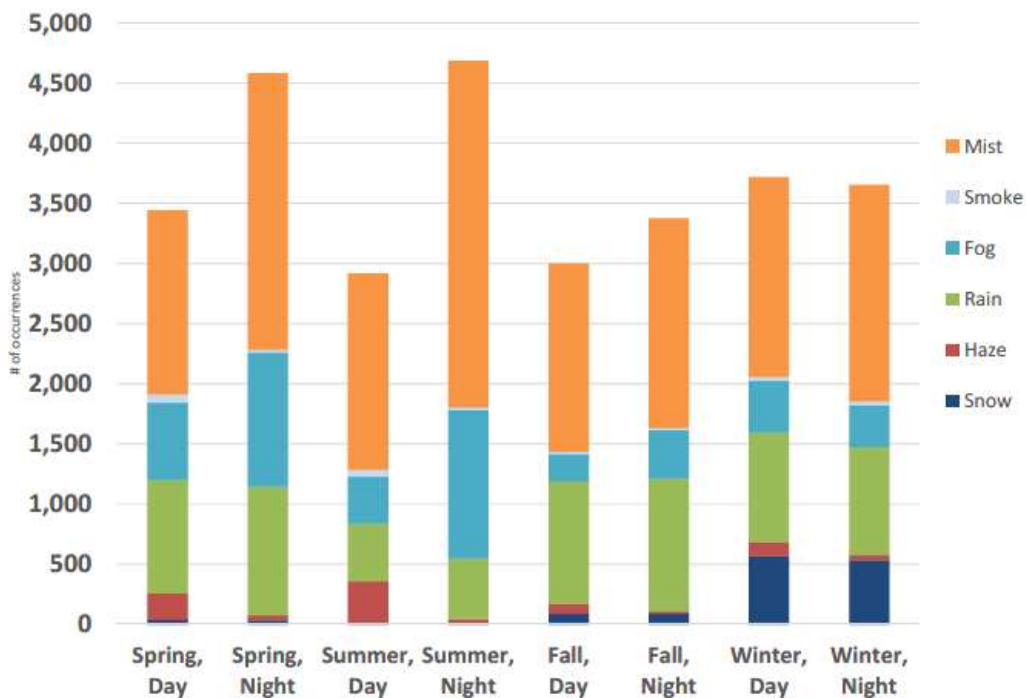
Visibility of the Offshore Wind Generation Facility can be reduced by fog, snow, particulate matter, smog, or any combination of them as part of normal atmospheric phenomena. A meteorological study commissioned by Vineyard Wind for the first 800 MW project indicates that haze, fog, and other atmospheric conditions limit visibility on Nantucket Island to less than 10 nm approximately 30% of the time on an annual basis (see **Table 15.2-1**). In general, views greater than 10 nm are obscured more frequently in the summer- 40% of the time on Nantucket Island during the summer months. The full meteorological study is included as **Attachment 15.2-2**.

Table 15.2-1 *Frequency of Visibility Ranges on Nantucket Island*

Visibility	Winter	Spring	Summer	Fall
Less than 10 nm	30%	34%	39%	26%
Greater than 10 nm	70%	66%	61%	74%

A more detailed picture of the distribution of visibility can be achieved by looking at the percent of hours in which a given threshold visibility distance is exceeded. For Nantucket, the highest visibility during the daytime occurs in the spring, with the lowest visibility occurring in the fall, summer, and winter. During nighttime, for Nantucket, the highest visibility occurs in the spring, and the lowest in the fall. **Figure 15.2-3** shows the frequency of common weather conditions on Nantucket Island, which is based on past meteorological data collected from the Nantucket airport weather station and reported in the meteorological study. Any condition comprising 2% or more of the reports in any season/time of day is included in the figure.

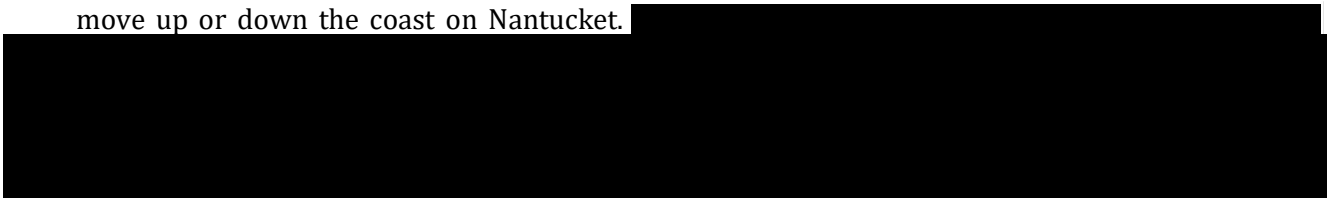
Figure 15.2-3 *Frequency of Common Weather Conditions at Nantucket Airport*



It is important to note that visibilities greater than 10 nm are still reported as 10 nm. Therefore, given the nearest shoreline vantage point over 30 mi (26 nm) away, it is reasonable to conclude that the project will be obscured from coastal vantage points more frequently than identified in **Table 15.2-1**. This will become even more frequent for points farther than this minimum distance and for WTGs farther offshore.

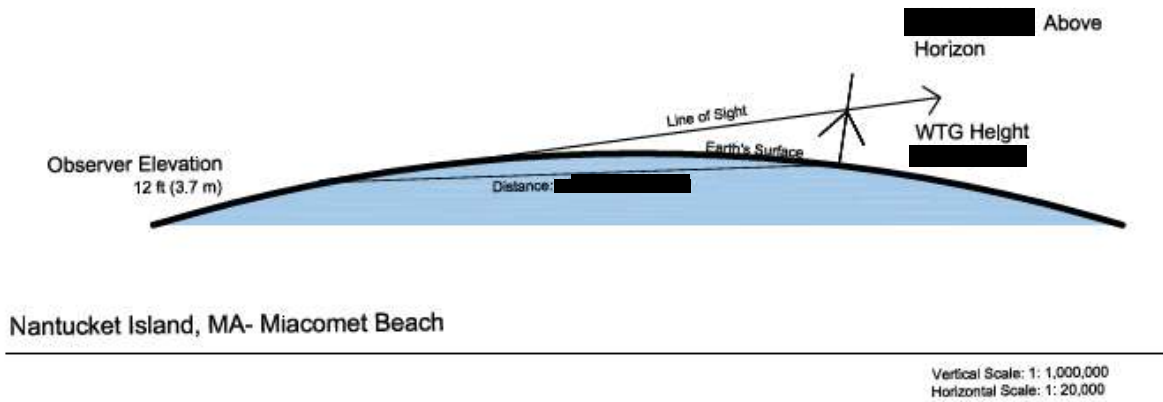
VISUAL ASSESSMENT RESULTS

From the nearest coastal vantage point, WTGs in the Offshore Wind Generation Facility site will be at least 30.4 miles away at Miacomet Beach on Nantucket Island. Viewing distances increase as viewers move up or down the coast on Nantucket.



From Miacomet Beach, only the upper portion of the closest WTG rotor blades are potentially visible above the horizon (see **Figure 15.2-4**). As shown in the photographic simulations (**Attachment 15.2-1**), the largest (e.g., most visible) portions of the WTG (foundation, deck, tower, nacelle, and FAA aviation obstruction lights) fall completely below the horizon and will not be visible from shoreline vantage points.

Figure 15.2-4 *Liberty Wind WTG Visibility from Miacomet Beach*

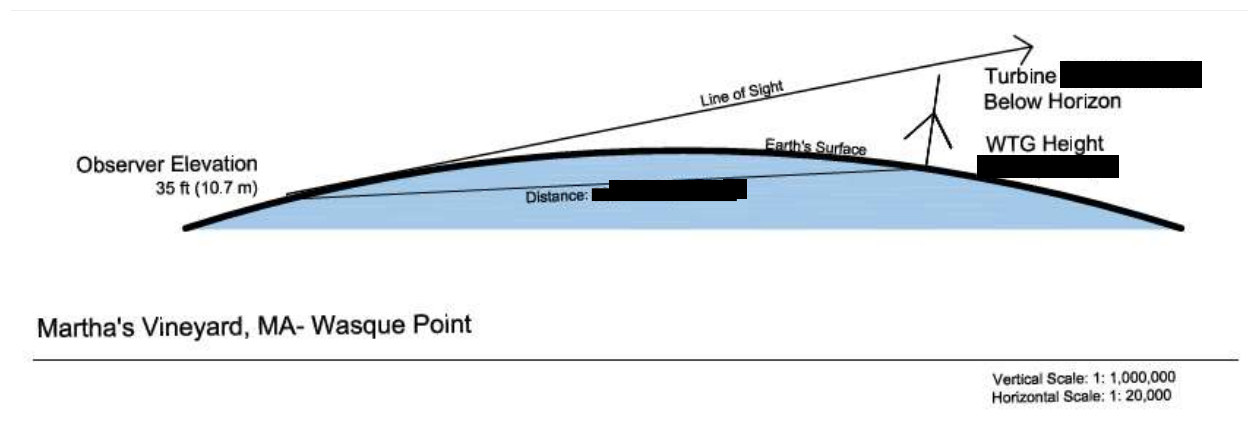


In addition, given the narrow width of turbine rotor blades combined with the distance from the viewpoints, these elements of the WTG that are potentially visible would be minimally discernible by the naked eye even in the best visibility conditions (i.e., a clear, low humidity day). In the case of long-distance views, theoretical visibility typically exceeds actual visibility. In seascapes, atmospheric haze reduces the practical viewing limit, sometimes significantly. The presence of waves will obscure objects very low on the horizon. The limits of human visual acuity reduce the ability of an observer

to discern objects at great distances, suggesting that even when mathematically visible above the horizon rotor blades may not be discernible to the human eye.

From nearest vantage point on Martha’s Vineyard, MA [REDACTED] and Long Island, NY [REDACTED] the Project falls completely below the visible horizon. **Figures 15.2-5** and **15.1-1** provide line-of-sight profiles illustrating potential visibility from these locations.

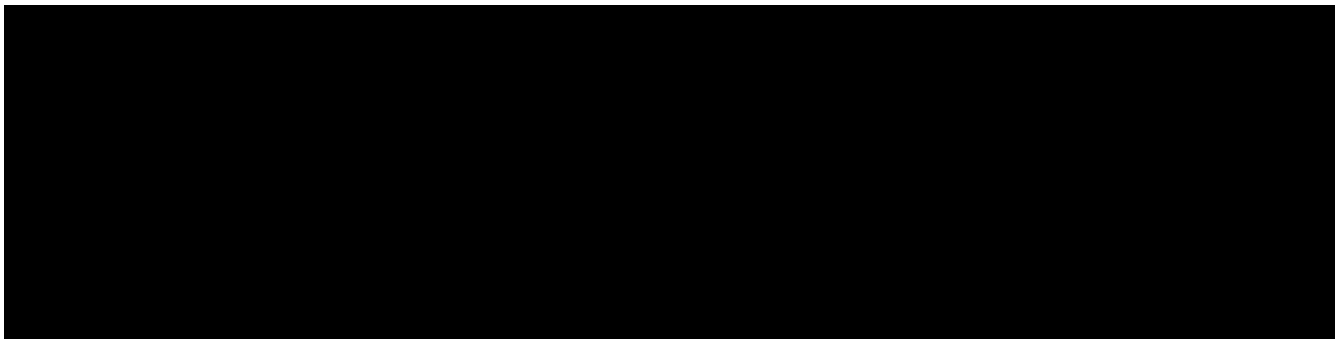
Figure 15.2-5 *Liberty Wind WTG Visibility from Wasque Point*



POTENTIAL VISUAL IMPACTS OF THE PROJECT

Onshore Visibility

As shown above and in the photographic simulations (**Attachment 15.2-1**), the Offshore Wind Generation Facility’s more than 30-mile distance to shore substantially limits potential visibility and viewshed impacts. At this distance, only the blade tips of WTGs appear above the horizon and are difficult to perceive. What’s more, the blade tips from only the closest WTGs would be visible; the WTGs in the southern portion of the Project area fall entirely below the horizon.



Meteorological Visibility

Visibility of the Offshore Wind Generation Facility will be reduced by fog, snow, particulate matter, smog or any combination of thereof, and is a part of normal atmospheric phenomena. Meteorological analysis indicates that haze, fog, and other atmospheric conditions limit visibility to less than 10 nm

approximately 30% of the time on an annual basis. In general, views greater than 10 nm are obscured more frequently during the summer - nearly 40% of the time on Nantucket. It is important to note that visibilities greater than 10 nm are still reported as 10 nm. Therefore, given the nearest shoreline vantage point is more than 30 miles, it is reasonable to conclude that the Offshore Wind Generation Facility, to the extent it is visible, will be obscured from coastal vantage points more frequently. In addition, the presence of sea spray and salts further affect visibility beyond what is reported in meteorological data.

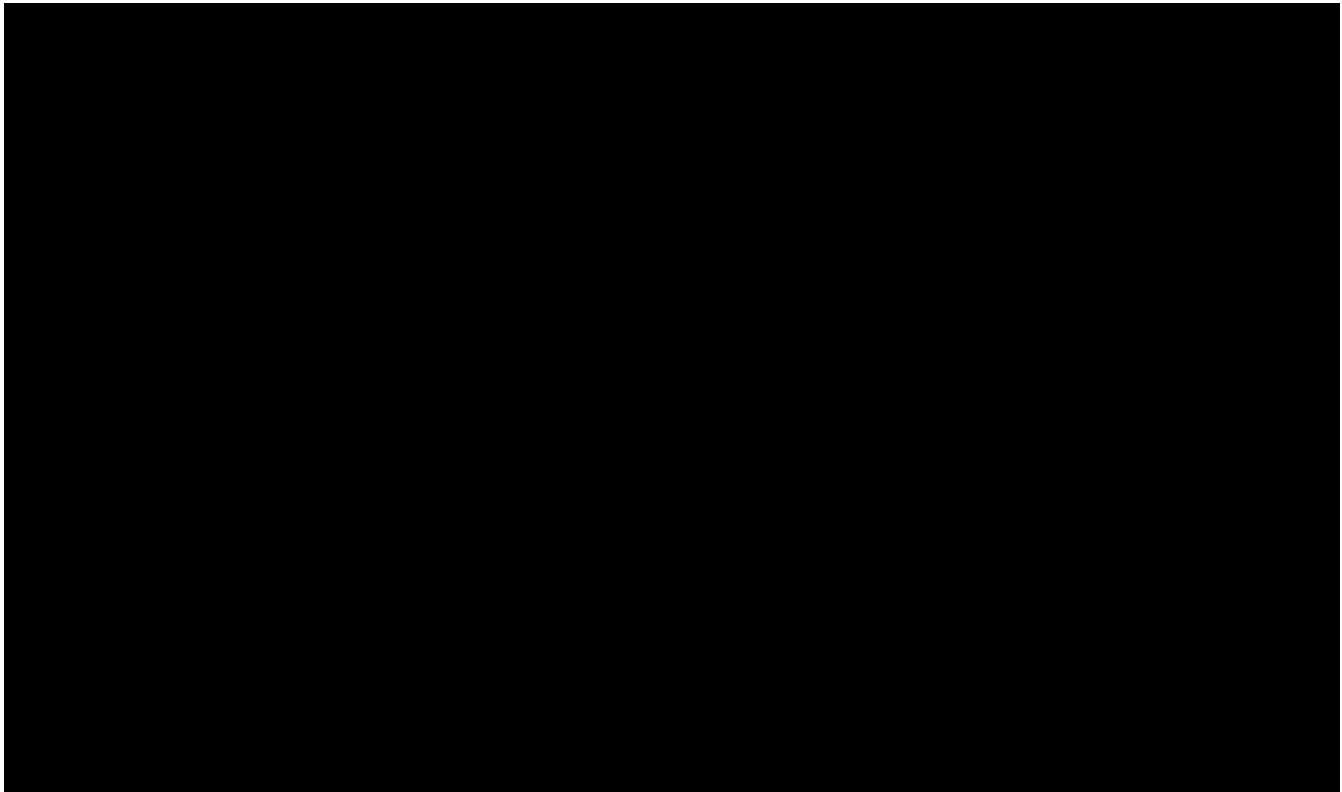
Visibility of Night Lighting

For all WTGs in the Offshore Wind Generation Facility, the nacelle falls below the horizon. Therefore, the Project's lighting controls will not be visible from the nearest sea level coastal vantage point.

Mitigation Measures

The sheer distance of the Offshore Wind Generation Facility from the nearest shoreline practically eliminates visibility and viewshed impacts. As the photographic simulations included as **Attachment 15.2-1** demonstrate, even the very small portion of the Offshore Wind Generation Facility that will be visible from the nearest vantage point on Nantucket Island is effectively indiscernible under all viewing conditions. Furthermore, the WTGs fall below the horizon from Martha's Vineyard and any land-based vantage point in New York.

As such, the need for mitigation options for the Project to reduce visibility and viewshed impacts is limited. Nevertheless, certain Project design elements will further mitigate any potential visibility and viewshed impacts. These include:



CONCLUSION

Due to its distance from any shoreline, the Offshore Wind Generation Facility would result in minimal change to landscape conditions for viewers along the Nantucket coastline. Viewers on the southern coast of the island will have very limited visibility of the blade tips of the WTGs and only during daylight hours when weather conditions allow. When viewed within the context of the ocean that includes the vast expanse of water, extended beach views and dunes, as well as the sights and sounds of breaking surf and wind, any visible portion of the Offshore Wind Generation Facility will be very difficult to perceive and visually subordinate to the wider landscape. For all other locations, including New York and Martha's Vineyard, the Offshore Wind Generation Facility falls entirely below the horizon and will not be visible from shore.



LIBERTY WIND

SECTION 16 - NEW YORK ECONOMIC BENEFITS

Proposal for New York State Energy Research and Development Authority in response to Request For Proposals for Purchase of Offshore Wind Renewable Energy Certificates



Photo: Yeja Mate offshore wind farm



SECTION 16 ECONOMIC BENEFITS PLAN

Proposers must submit their claimed Incremental Economic Benefits and Contingent Economic Benefits by category using the Offer Data Form and support these claims by submitting an Economic Benefits Plan. All claimed expenditures and investments should be in real dollars (U.S.) at the time of Proposal submission.

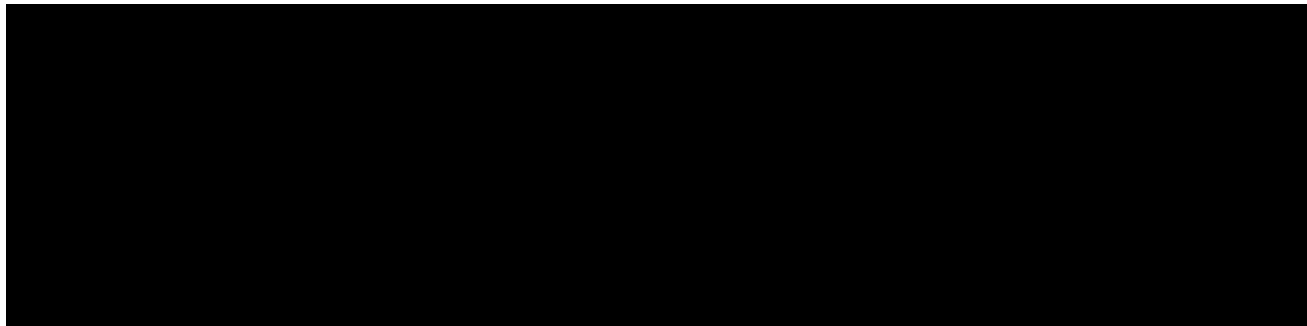
The Economic Benefits Plan must include descriptions and supporting documentation for their Incremental Economic Benefits and Contingent Economic Benefits claims, as described below. The prorated portion of investments in oversized transmission and interconnection facilities not needed to support the Offshore Wind Generation Facility shall not be included as an Economic Benefit.

LIBERTY WIND - ECONOMIC DEVELOPMENT FOR NEW YORK

Liberty Wind (the “Project”) will provide an array of economic development benefits to New York. First and foremost, the Project will deliver abundant offshore wind energy at affordable prices. At the same time, the Project will catalyze the rapid development of the offshore industry in New York, which will generate economic development benefits across the state. Liberty Wind will itself be directly responsible for economic benefits of [REDACTED] and contingent economic benefits of at least [REDACTED] for a total benefit package of [REDACTED]. The Project will also create an estimated [REDACTED] (full-time equivalent) FTE job years between contract award and the first three years of the Project’s operation.

NYSERDA can count on these benefits as well as others. The entities behind Liberty Wind- Vineyard Wind, Vineyard Wind’s parent companies, and transmission partner Anbaric (as described in **Section 6**) have demonstrated their ability to deliver major infrastructure projects – both offshore wind and high voltage direct current (HVDC) transmission projects–on time and on budget. The same will be true for Liberty Wind.

The economic development package elaborated herein shows how Liberty Wind will deliver substantial incremental economic benefits to New York. The key initiatives of the package are illustrated in **Figure 16.1-1**. These initiatives are designed to support New York’s efforts to launch the offshore wind industry and provide benefits that are in addition to those generated by the Project.

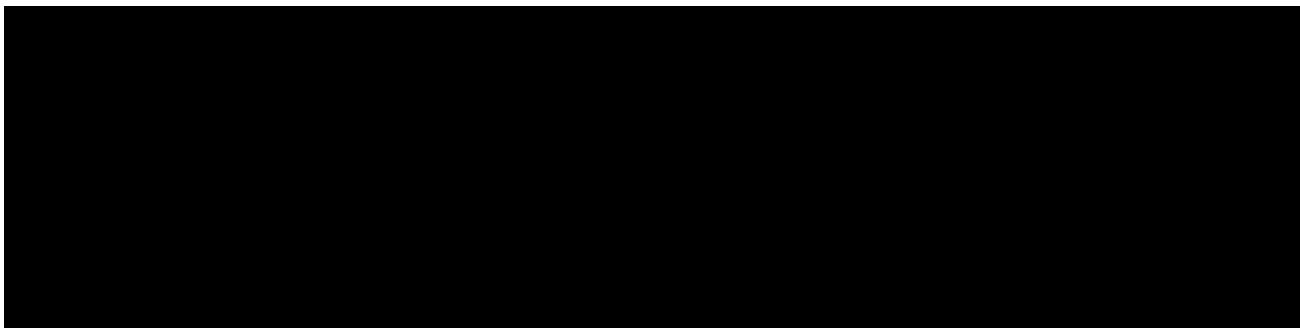




Economic Opportunity and Benefits for Local Communities. Vineyard Wind is already working with several New York-based companies to develop the Project. With this proposal, Vineyard Wind is offering additional opportunities for New York businesses, communities, and residents to participate in and directly benefit from the country’s rapidly emerging offshore wind sector. Vineyard Wind also pledges to work with the Cuomo administration, NYSERDA, and organized labor leaders to create a best-in-class workforce development program that will prepare New York residents for high paying jobs in the offshore wind industry.

Distributing Benefits Across New York. As important as the total amount of economic benefits is, Liberty Wind has taken steps to distribute these benefits across New York, with sizable investments and economic benefits accruing to the Capital Region, Long Island, and New York City.


Meeting New York’s Offshore Wind Target While Reducing Costs. Liberty Wind sets the stage to meet New York’s ambitious 9,000 MW offshore wind target at affordable and competitive prices. The Project’s economic development package includes investments and initiatives to lower the cost of future offshore wind projects, such as upgrades to New York marine infrastructure, R&D, and funding to accelerate the development and expansion of New York’s supply chain.

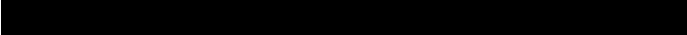


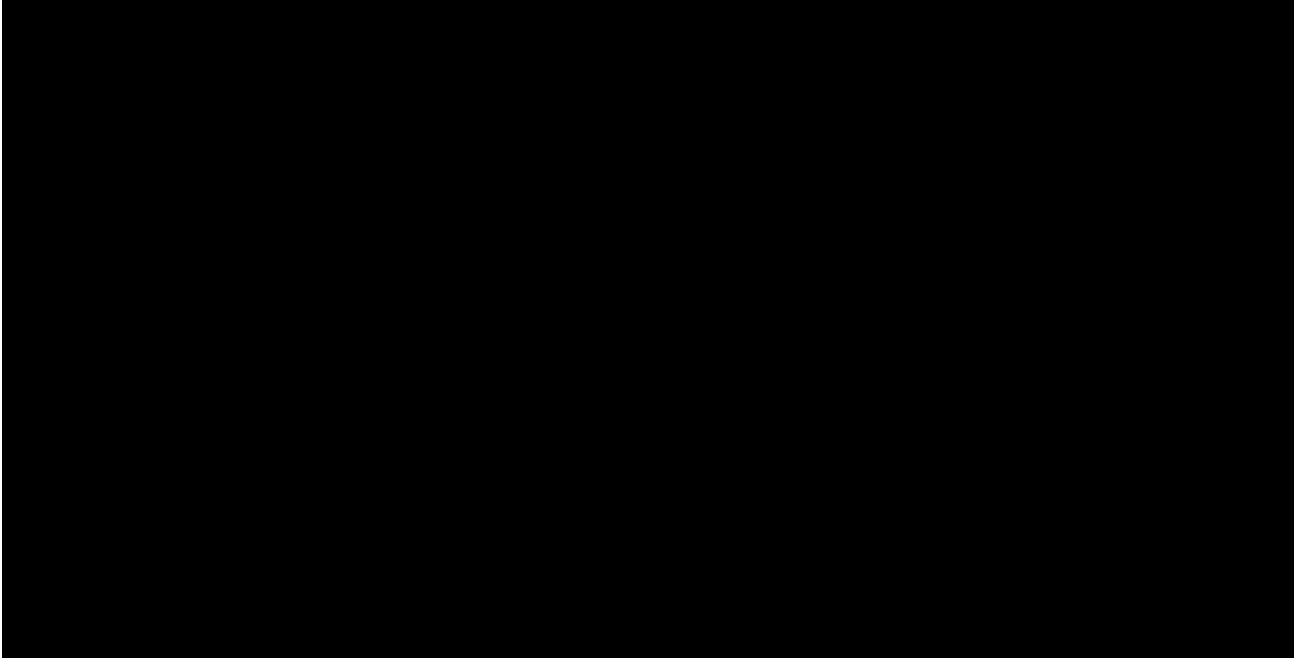
Further details about how Liberty Wind’s economic development package relates to the Category 1, Category 2, and Category 3 Economic Benefits listed in the proposal’s offer data form are included in **Table 16.1-1** and **Table 16.1-2** at the end of this section.



DISTRIBUTING LIBERTY WIND EXPENDITURES ACROSS THE STATE OF NEW YORK

Liberty Wind's commitment to construct key elements of the Project using New York port facilities, Suppliers, and labor is designed to provide sizable economic opportunity while distributing benefits across the state, as illustrated in **Figure 16.1-1**. 

 These are explained in more detail below.

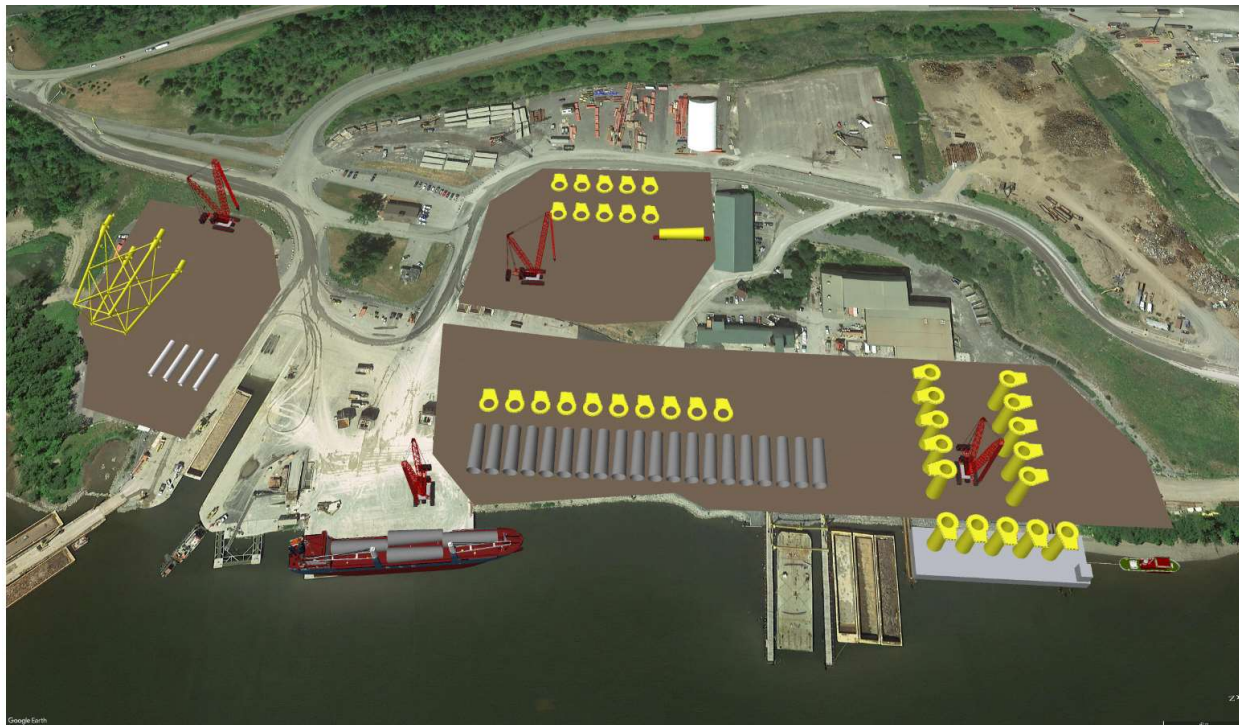


The Capital Region - Fabricating foundation components at New York Port facilities

Liberty Wind's plans to stage and assemble offshore wind project components at New York ports will bring substantial steel work and offshore wind fabrication jobs to the state and the Capital Region. As detailed in **Sections 9** and **11**, Vineyard Wind will fabricate, paint, and outfit the Project's foundation transition pieces (TP) as well as the jacket foundation for the Project's electrical service platform (ESP) at New York port facilities (see **Figure 16.1-2**). Vineyard Wind has already entered into an option lease agreement with the Port of Coeymans (Coeymans) to ensure the facilities at this location are available for TP assembly and ESP jacket foundation fabrication and load-out when needed (see **Attachment 16.1-2**). This labor-intensive work will create new jobs and build valuable New York-based offshore wind capabilities and capacity that can be employed in future offshore wind projects.



Figure 16.1-2 Transition Piece and ESP Fabrication at the Port of Coeymans



The Port of Coeymans. Vineyard Wind has selected the Port of Coeymans in Albany County as the principal site for TP and ESP fabrication activities following careful analysis and site visits to a number of New York port facilities. Coeymans is controlled by the Carver Companies, a privately held family of companies owned by Carver Laraway. While Coeymans is farther away from the Offshore Wind Generation Facility site than other New York port facilities, Vineyard Wind’s analysis shows that Coeymans is the most viable facility for offshore wind construction work. The viability of the Coeymans site has been further confirmed with prospective foundation contractors.

Coeymans is a 400-acre facility with 3,500 ft of river front access. The port has access to a skilled workforce and has experience with large projects, including the Governor Mario M. Cuomo Bridge and the 130 ft tall, 4,000-ton heat recovery steam generators for PSEG. The latter is similar in size and weight to an ESP jacket foundation.

Before fabrication work begins, Vineyard Wind expects to work with the Governor’s *Regional Economic Development Council of the Capital District* as well as *Albany’s Center for Economic Growth* to identify opportunities to maximize local business participation in the fabrication activities. Vineyard Wind also anticipates working with local organized labor leaders to execute Project Labor Agreements (PLAs).



[REDACTED]

[REDACTED]

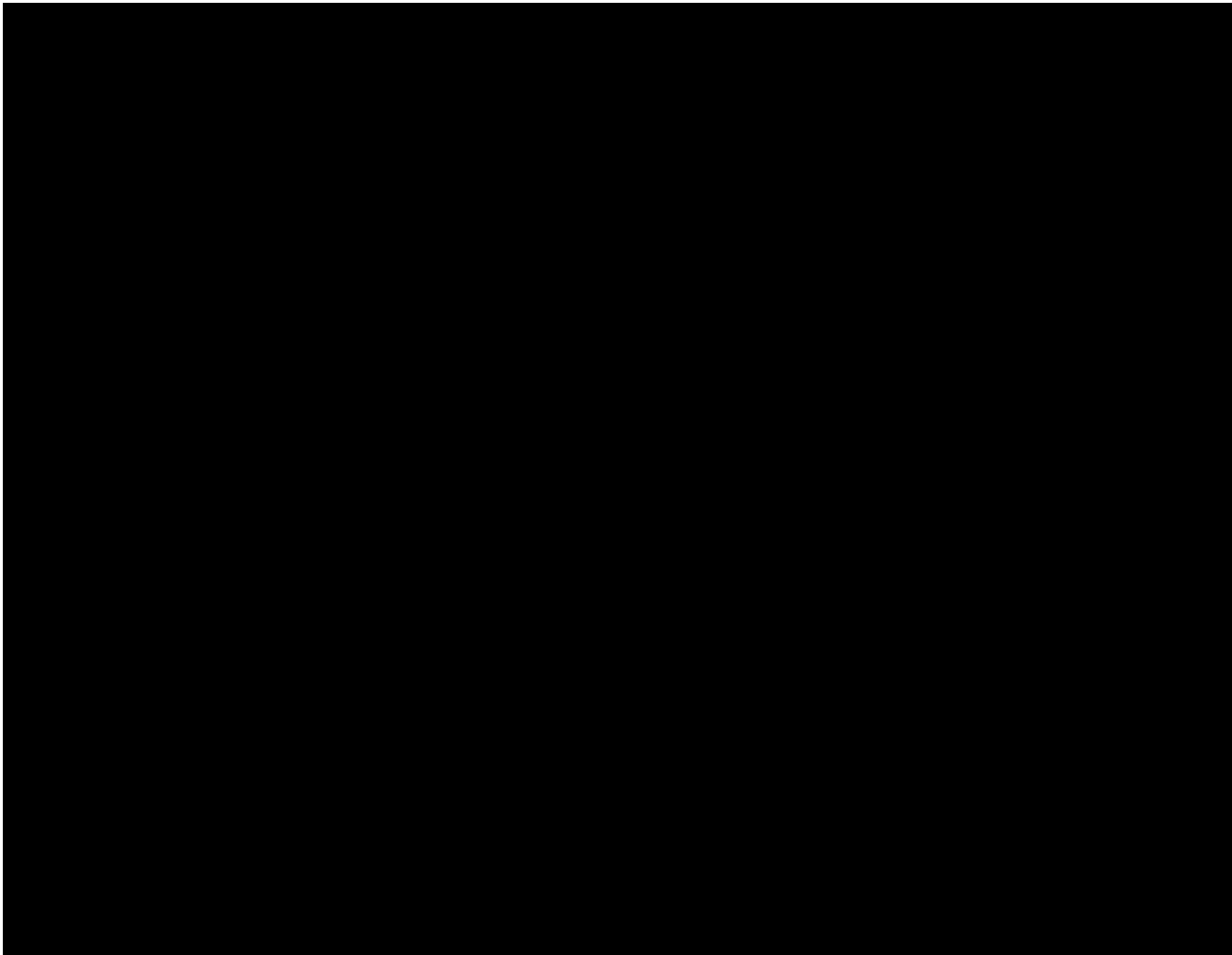
[REDACTED] These fabrication activities will provide jobs for stevedores, crane operators, welders, fitters, drivers, painters, supervisors, and electricians in Albany County for a period of approximately two years.

Long Island - Constructing onshore underground cable and transmission infrastructure

The design and construction of the Project's onshore transmission system will trigger substantial local expenditures for a total estimated value of [REDACTED] during the Project's construction phase including lease payments, to a local property owner property for the onshore substation and converter station.

Liberty Wind's onshore transmission system (see **Figure 16.1-3**) is comprised of the following:

- Offshore export cable landfall location at [REDACTED]
- [REDACTED] underground land cable; and
- Onshore substation, converter station, and underground cable to grid interconnection point [REDACTED]



The design and construction work for the Project's onshore transmission system will be subcontracted to seasoned Long Island and New York [REDACTED]

[REDACTED] Construction activities will provide jobs for construction workers, electricians, drivers, heavy equipment operators and supervisors, pavers, landscapers, and other positions. Materials and machinery will also be sourced locally.

In addition to the onshore cable route, the Project also triggers transmission upgrades for Long Island's grid, depending on the size of the Project chosen, as described in **Section 7**. [REDACTED]

New York City – New York Project team and office, vessels, and construction financing

Vineyard Wind and Anbaric have already established local offices in New York. Upon execution of a contract with NYSERDA, the companies will establish an additional Project-specific office and Project team in New York City. Liberty Wind will also use New York-based vessels and crews for several of



the campaigns throughout the life of the Project [REDACTED]
[REDACTED]
[REDACTED]

A New York Office and Project Organization. The office will be largely staffed with New York employees and designed to accommodate the [REDACTED] team [REDACTED]
[REDACTED]

[REDACTED] Liberty Wind's Project office in New York will result in numerous jobs being created in-state and facilitate the Project's efforts to work with New York businesses and suppliers. The types of jobs that will be directly created or supported by Liberty Wind's office in New York and Project development and construction efforts include project developers, project managers, contract managers, and technical specialists who lead the development and construction of the Project as well as surveyors, survey technicians, engineers, drafters, scientists, and technicians.

New York Vessels. During the development and construction phase, the Project will require multiple vessels in addition to the main specialized installation vessels [REDACTED]
[REDACTED]
[REDACTED]
[REDACTED]
[REDACTED]
[REDACTED]
[REDACTED]
[REDACTED]

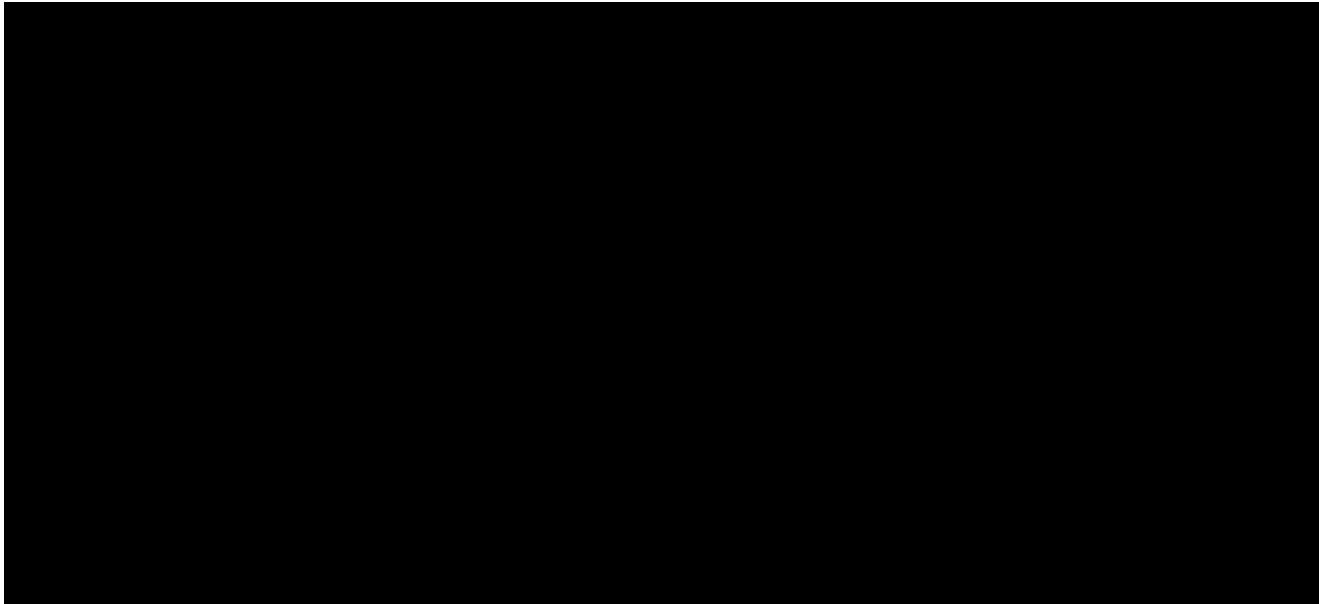
[REDACTED] Vineyard Wind's payments for goods and services to New York maritime companies will provide work for captains, mates, sailors, pilots, mechanics, and engineers.

[REDACTED]



DIRECTLY FUNDED INITIATIVES TO ACCELERATE NEW YORK OFFSHORE WIND LEADERSHIP

Liberty Wind's economic development package also includes a set of initiatives to support supply chain development, job growth, training, and R&D that will accelerate development of a capable New York supply chain and workforce and support New York in becoming the national leader in offshore wind. Liberty Wind's economic development package includes [REDACTED] in funding in support of the initiatives outlined in the **Figure 16.1-4** below. Vineyard Wind and Anbaric anticipate working with the Cuomo Administration and NYSERDA to further shape these grant programs to maximize potential benefit to New York.



Supply Chain Development Grants to Grow a New York-based Offshore Wind Supply Chain

Liberty Wind's supply chain development grant program will fund grants to New York businesses for the purpose of reducing the costs of entry for new players in the offshore wind industry or encouraging new and existing businesses to setup shop in New York. Grants will be used to offset capital expenditures such as new equipment purchases, facility upgrades in or near New York's major ports that help New York businesses service the offshore wind industry in New York, the US, and internationally. In addition to grants, the program could also include zero or low interest and/or unsecured loans in order to further leverage the funds to build a local supply chain.

New York businesses that could benefit from the grant program [REDACTED]



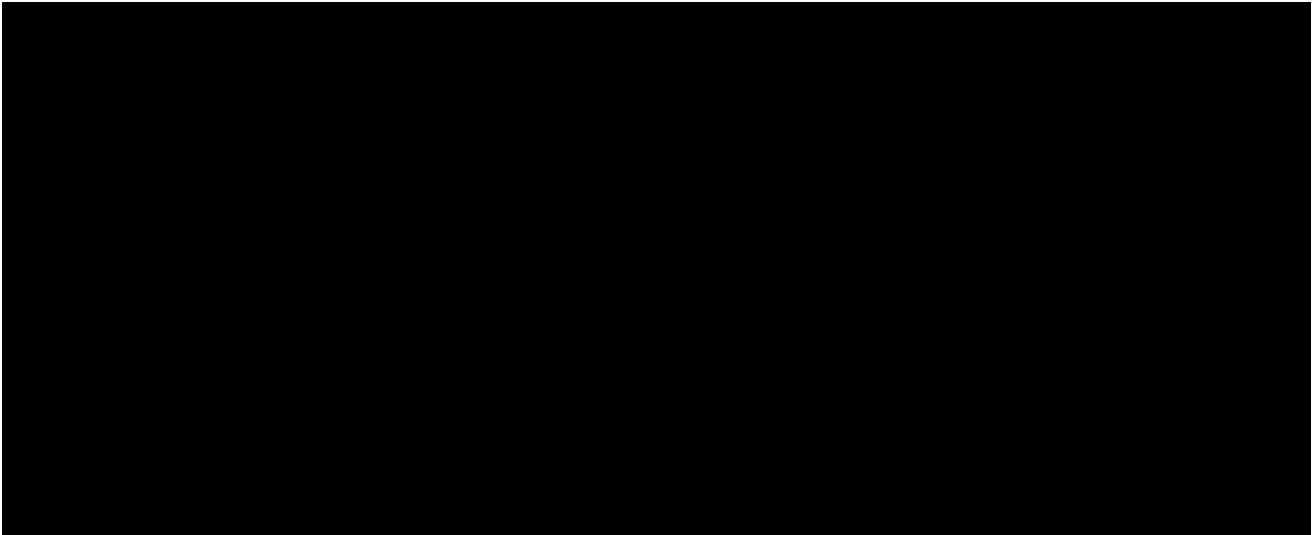
The grant program will help create and accelerate the creation of local jobs in New York that last beyond a single project and generate economic benefits that are at least severalfold greater than the initial amount invested. The program's funding would be made available after the Project's financial close. Vineyard Wind will work with NYSERDA and Empire State Development as well as the



Governor’s Regional Economic Development Councils and local business groups in Albany County, New York City, and Long Island to implement this program and ensure its success.

Workforce Programs Building on NYSERDA’s Clean Energy Workforce Initiative

Liberty Wind’s workforce development program will enable a diverse range of New York residents to obtain one of the many long-term, good paying jobs available in the offshore wind industry and supporting sectors. The program builds on NYSERDA’s \$70 million clean energy workforce development initiative, Governor Cuomo’s \$175 million Consolidated Funding Application for regional workforce investments announced during the 2019 State of the State address, and New York’s other commitments to expand job opportunities in the offshore wind industry.



Vineyard Wind and Anbaric will work with [redacted] to ensure the success of the program and design workforce training programs that meet the local workforce’s needs.

Strategies currently under consideration for the program include:

- ***Educational grants*** [redacted]
- ***Technical training*** [redacted]
- ***Grants for trades councils and organized labor organizations*** [redacted]



Funding R&D to Unleash the Vast Potential of Offshore Wind

Liberty Wind will support R&D initiatives focused on reducing the cost of offshore wind by expanding scientific knowledge and supporting technological advancement. New York’s recently announced goal of deploying 9,000 MW of offshore wind by 2035 has focused the attention of the global offshore wind industry on New York. The US Department of Energy’s (DOE) creation and funding (along with NYSERDA) of a National Offshore Wind Research and Development Consortium (the “Consortium”) puts the opportunity and the resources on Long Island for effective, industry-guided research that lower costs and accelerates growth.



Supporting the National Offshore Wind R&D Consortium. The Consortium, funded by the US DOE and NYSERDA, will play an essential role in identifying and funding research into a range of technical, systems management, and policy questions that need to be answered to successfully build a vibrant new domestic offshore wind industry in New York and other parts of the country. Both Vineyard Wind and Anbaric were elected to the Consortium’s Board of Directors on January 22, 2018. As Board of Director members and Private Sponsor members, both companies will provide financial support (through membership fees) and lend expertise to the Consortium.

Permanent Access to a Turbine platform for R&D and Workforce Training. Vineyard Wind will provide access to one of Liberty Wind’s WTGs to SUNY Stony Brook, SUNY Maritime College, other New York State universities, and not-for-profit research through the Consortium institutions for R&D activities, equipment testing, and workforce training:

R&D and demonstration activities. [Redacted]

Equipment testing. [Redacted]



[Redacted text block]

Workforce training. [Redacted text block]

Funding Social Benefit Programs and Other Community Investments

Vineyard Wind and Anbaric seek to be good corporate citizens and neighbors with every project. For Liberty Wind, the companies are providing community benefits to the communities in New York that may be impacted by the Project or other communities. [Redacted text block]

[Redacted text block]



BUSINESS ENGAGEMENT PLAN

A successful business engagement plan affords ample opportunity for businesses to learn about and participate in a project's development, procurement, and execution. Central to this is broad communication about invitations to tender (ITTs) and requests for bids well before such opportunities become available. Early, open, and transparent communication facilitates local business participation and helps build relationships between developers and suppliers.

Liberty Wind will work with local community leaders and organizations in the Capital Region, New York City, and Long Island to advertise the Project's procurement opportunities and network with local businesses. [REDACTED]

[REDACTED]

[REDACTED]

Vineyard Wind also notes that the Project is already benefitting from support provided by several New York companies and institutions, such as [REDACTED]

[REDACTED] Following contract award, the Project will provide substantial additional opportunities for New York-based companies and residents to play a part in the Project's development, construction, and operation. Additional aspects of Liberty Wind's business engagement plan are described below.

[REDACTED]



[REDACTED]

[REDACTED]

[REDACTED] Specifically, for port facilities, Vineyard Wind will execute option lease agreements, such as the option lease agreement with the Port of Coyemans described earlier, to ensure control of the facilities and require their use for specific construction activities. For other categories, Vineyard Wind will also include requirements and targets for using New York supply chain or labor.

Reporting on Business Engagement and Supplier Opportunity. Following execution of a contract with NYSD, Vineyard Wind will begin documenting progress on business engagement and compliance with the New York supplier opportunity requirement, in accordance with the contracting requirement, through bi-annual or quarterly reports progress reports. The final format of the reporting will be validated with NYSD.

The progress reports are expected to include the following:

- Scope of work and estimated value of the scope;
- List of New York companies invited to tender; and
- Evidence that New York companies have been made aware of different opportunities

WORKFORCE ENGAGEMENT PLAN

Liberty Wind's workforce engagement plan ensures access to a skilled workforce with the necessary skills to build, install, and maintain the Project. The workforce engagement plan described in this section is in addition to the workforce development initiatives described above.

Tradespeople belonging to local unions will play a major role in fabricating and installing Liberty Wind's offshore and onshore components. [REDACTED]

[REDACTED]

Given the newness of the offshore wind industry in the US, some tradespeople may require training before they can full take advantage of opportunities in the sector. As such, Vineyard Wind will fund and support workforce development programs for tradespeople- consistent with our supplier contracts with suppliers and PLA commitments [REDACTED]

[REDACTED]



[REDACTED]

[REDACTED] A training program developed at this institution will serve as a model for other institutions while training the next generation of workers who will play a central role in designing and building the country's offshore wind projects.

ECONOMIC BENEFITS VERIFICATION PLAN

The following describes Liberty Wind's economic benefits verification plan.

Upon award of a contract with NYSERDA, Vineyard Wind will [REDACTED]

[REDACTED]





OVERVIEW OF THE INITIATIVES LISTED IN THE OFFER DATA FORM

The following provides an overview of Liberty Wind's economic development package described above and the relation to the Category 1, 2, and 3 incremental and contingent economic benefits estimated for New York. **Table 16.1-1** illustrates each of the key initiatives explained above in relation to the Category 1 and Category 2 ID's listed in the Offer Data Form included with the current proposal. Additionally, **Table 16.1-2** lists the Category 3 Input Activities noted in the Offer Data Form for this proposal in relation to Liberty Wind's key initiatives described above.

